

IPv6 - IPv4 Translators Problem Statement and Analysis

Marcelo Bagnulo

IETF 70

Goal of the draft

- Define requirements for IPv6 - IPv4 Translators
 - application behaviour
 - acceptable modifications
 - Placement of the NAT64

Supported Application behaviour (I)

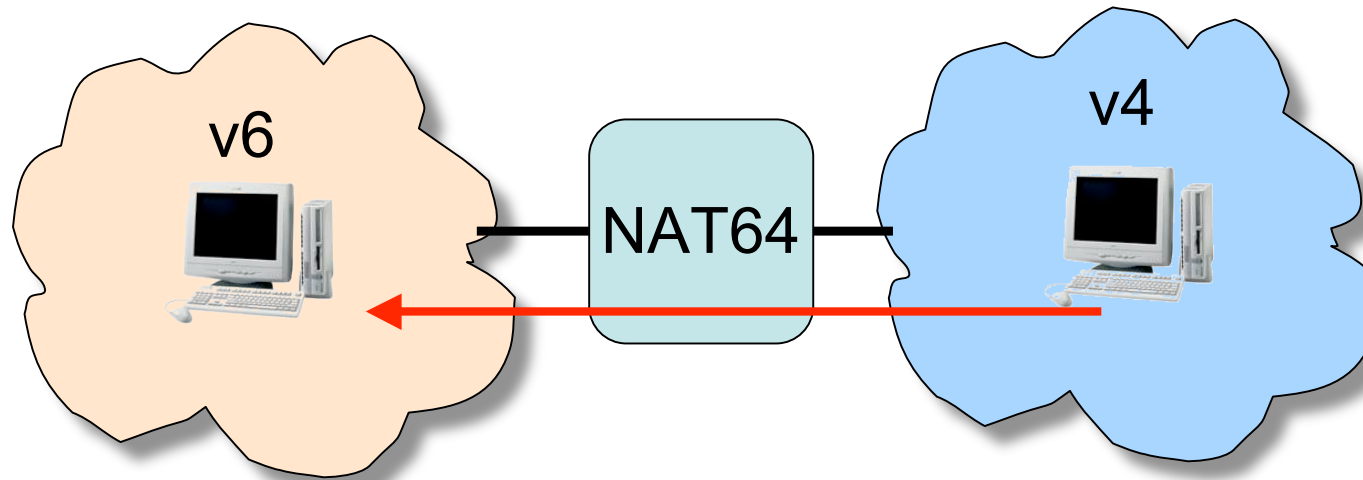

1.1. v4-initiated short lived local handle

Only usage of the address is to pass it from DNS API

Supported Application behaviour (II)

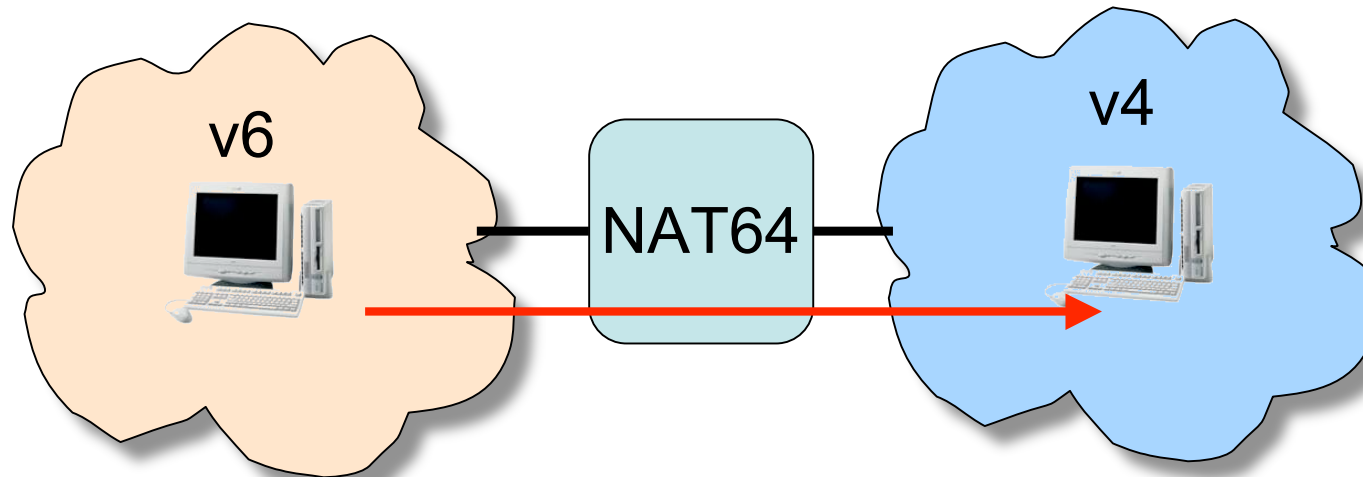

1.2. v6-initiated short lived local handle

Only usage of the address is to pass it from
DNS API

Supported Application behaviour (III)

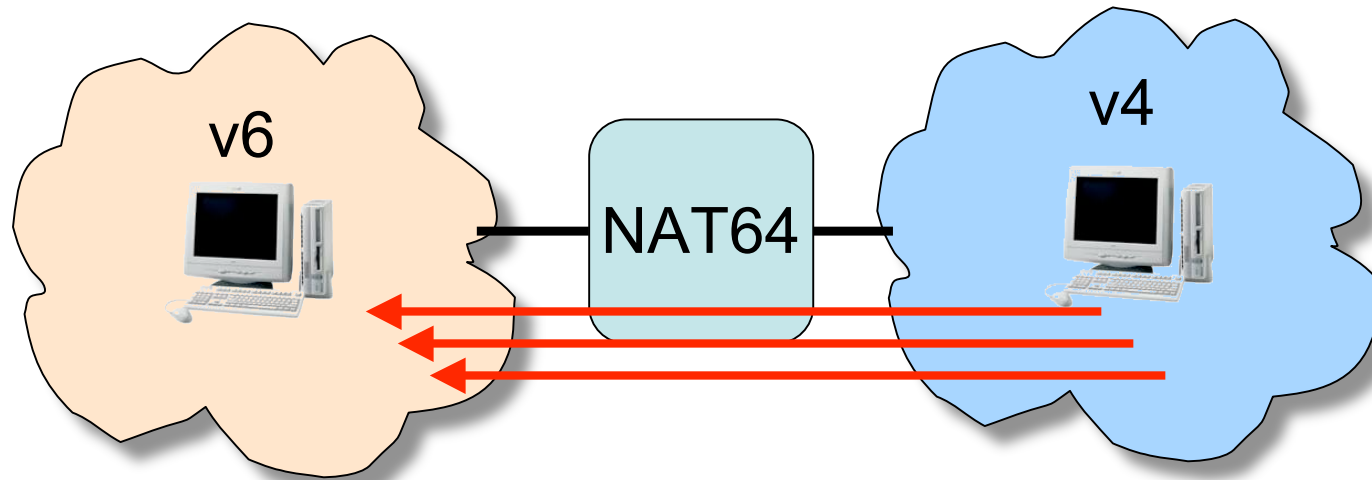

2.1. v4-initiated long lived communications
IP address retained through multiple communications

Supported Application behaviour (IV)

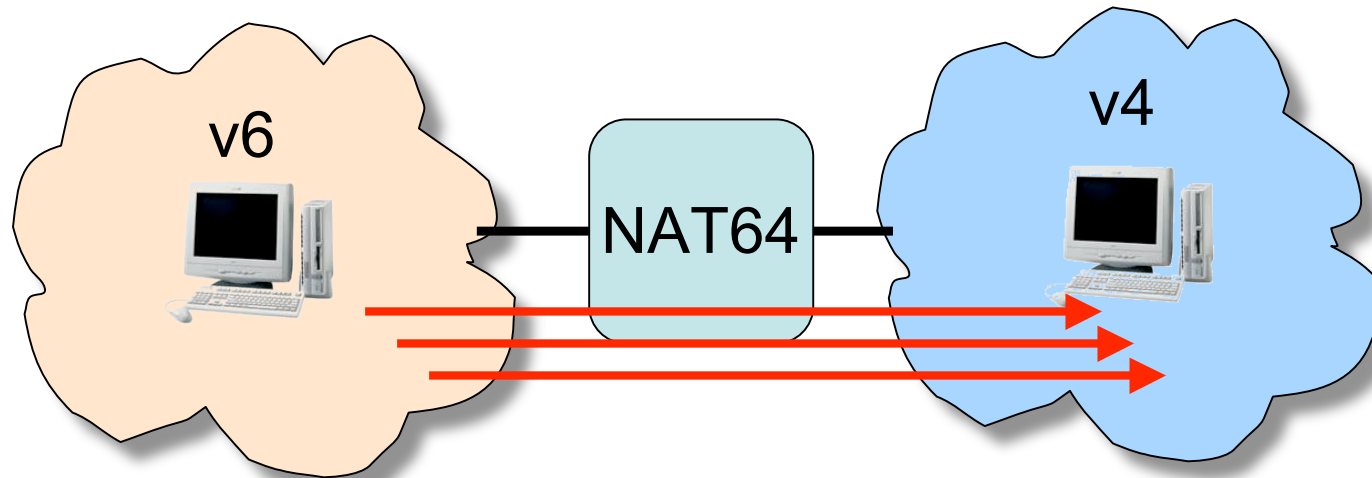

2.2. v6-initiated long lived communications
IP address retained through multiple communications

Supported Application behaviour (V)

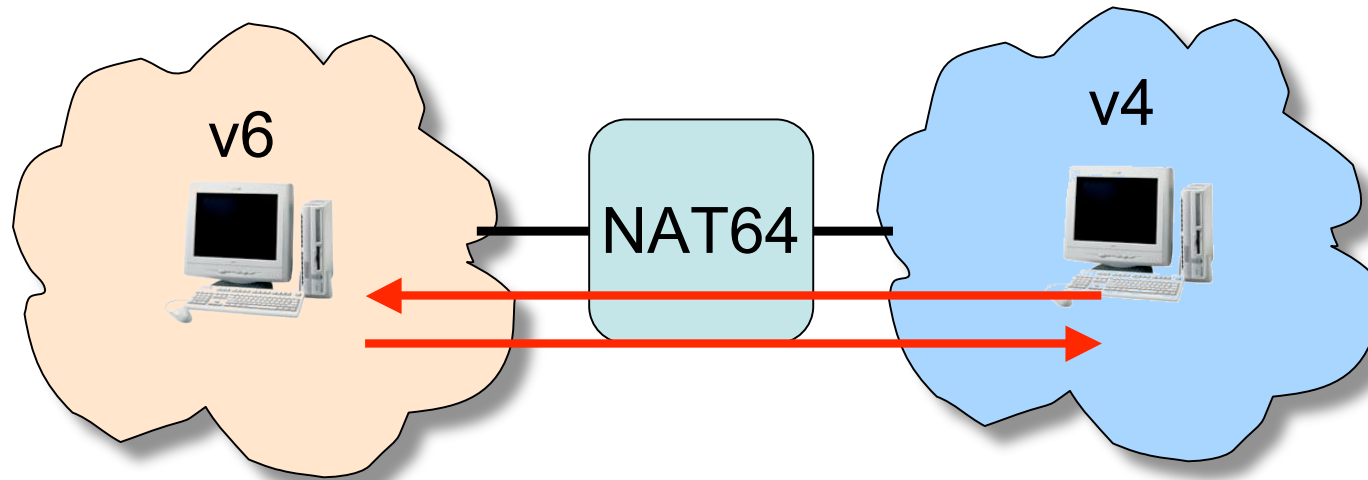

3.1. v4-initiated call-backs

Supported Application behaviour (VI)

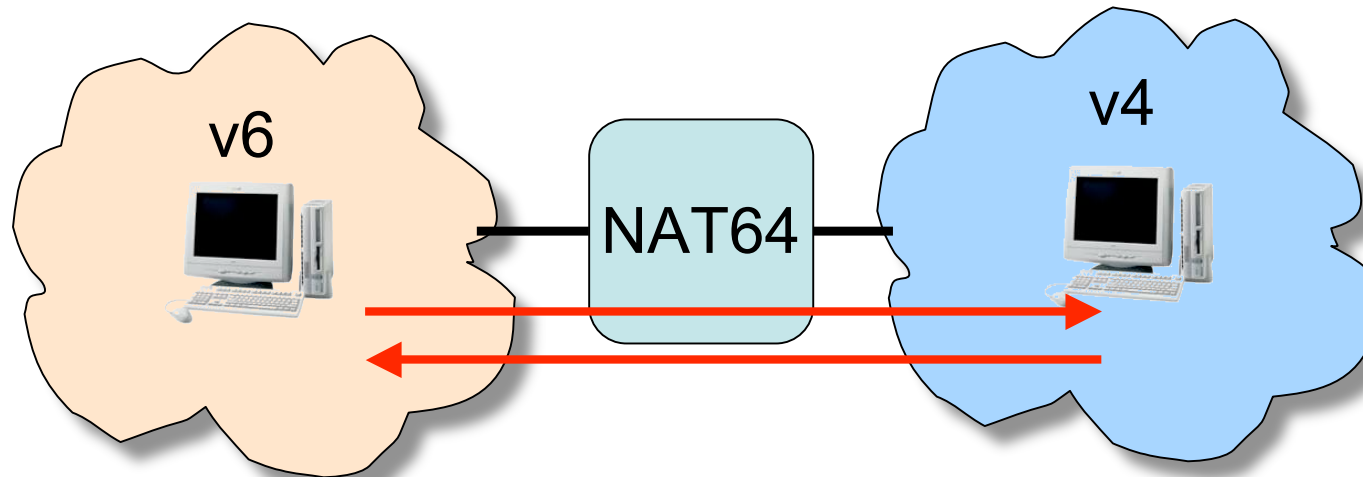

3.2. v6-initiated call-backs

Supported Application behaviour (VII)

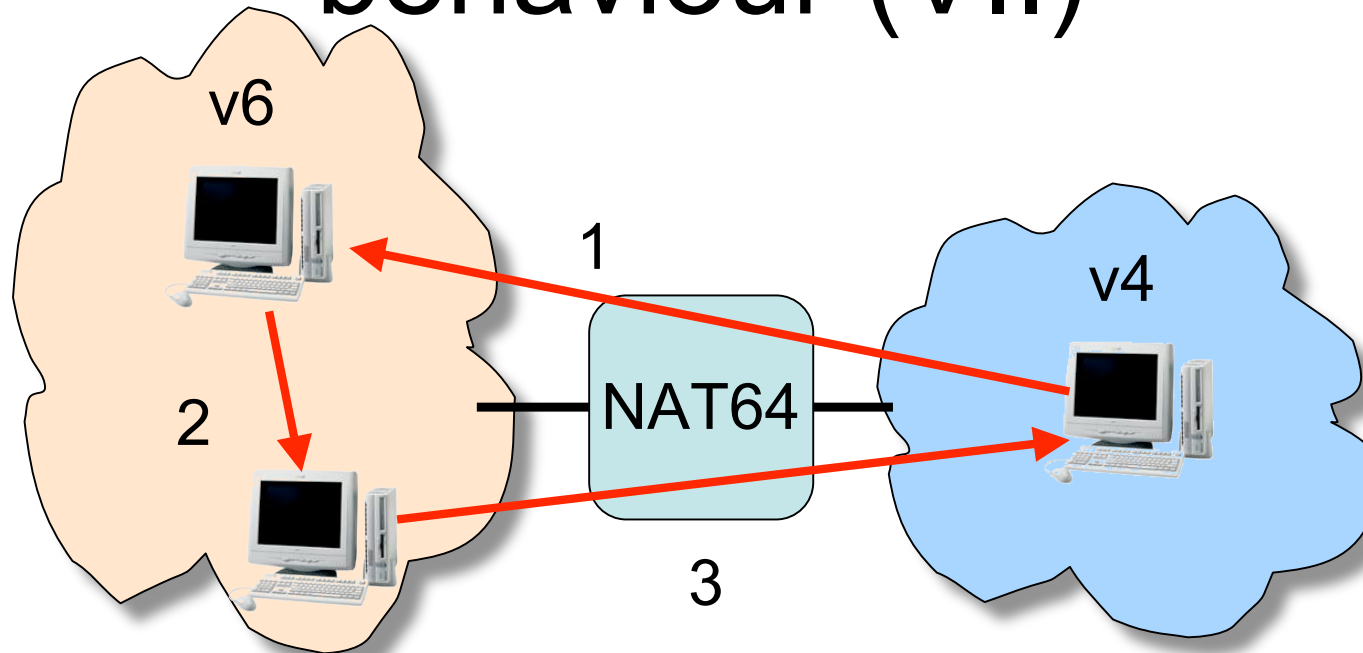

4.1. v4-initiated v6-in-v6 referral

Supported Application behaviour (VII)

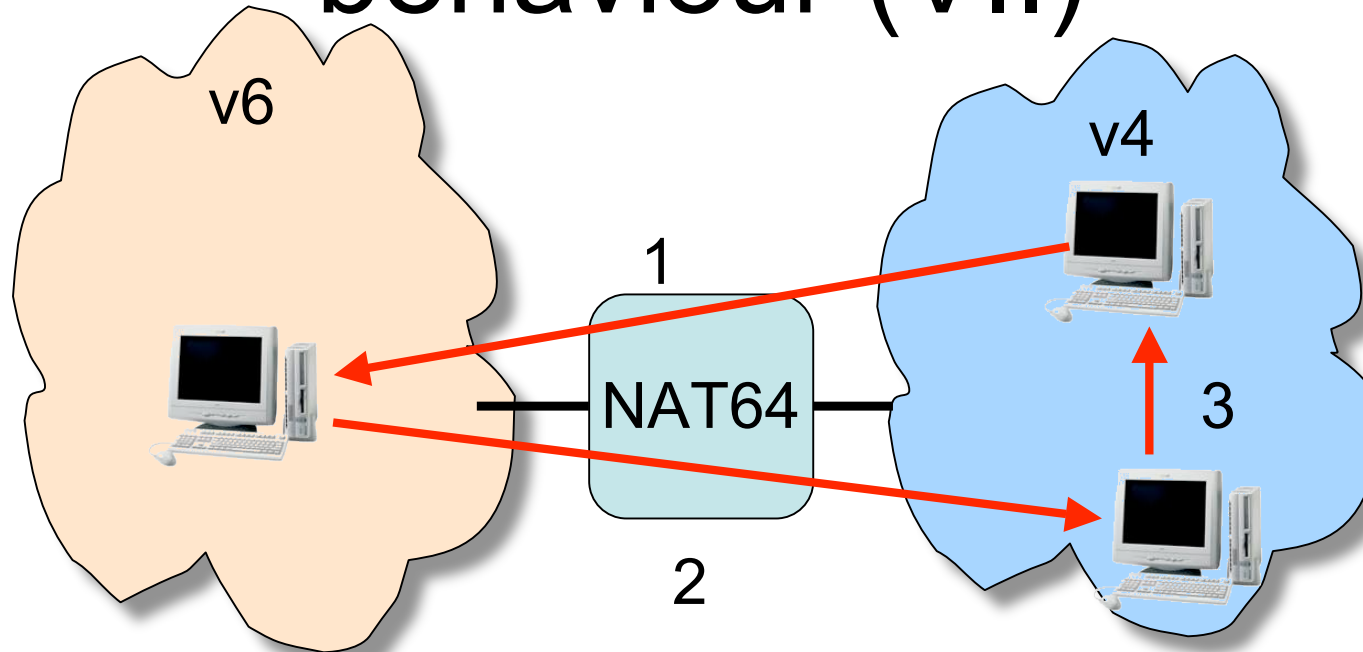

4.2. v4-initiated v6-in-v4 referral

Supported Application behaviour (VII)

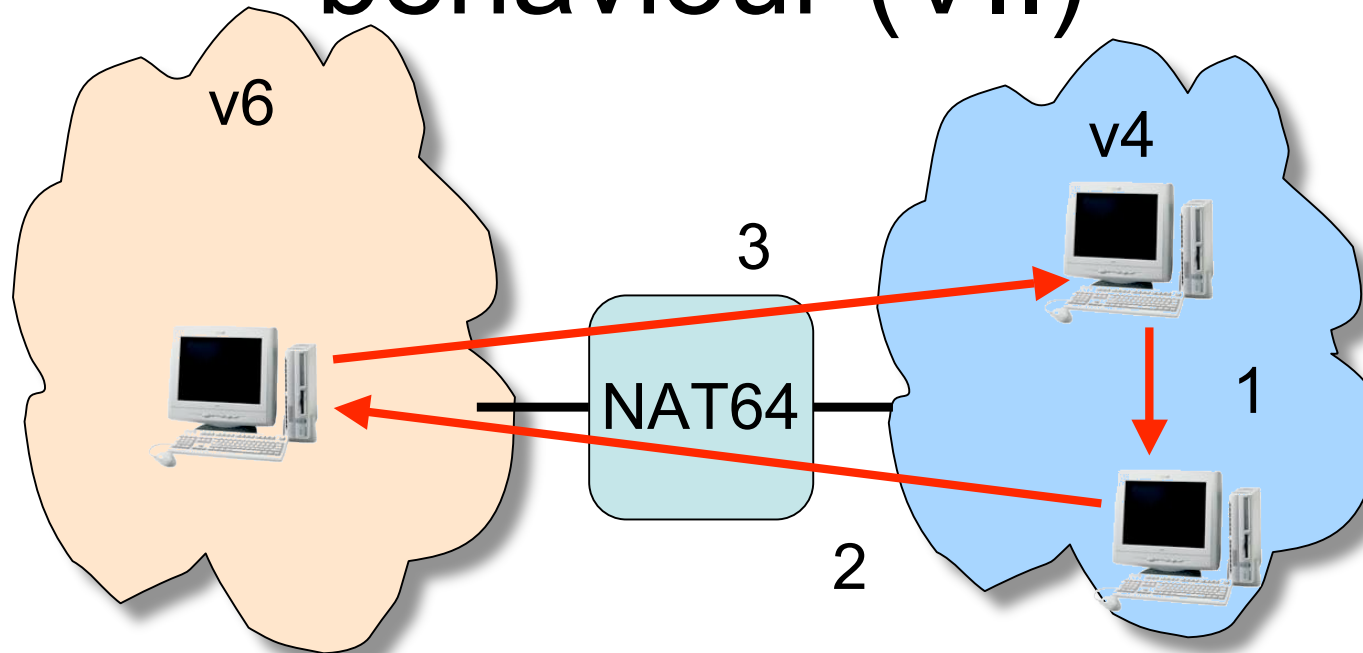

4.3. v4-initiated v4-in-v6 referral

Supported Application behaviour (VIII)

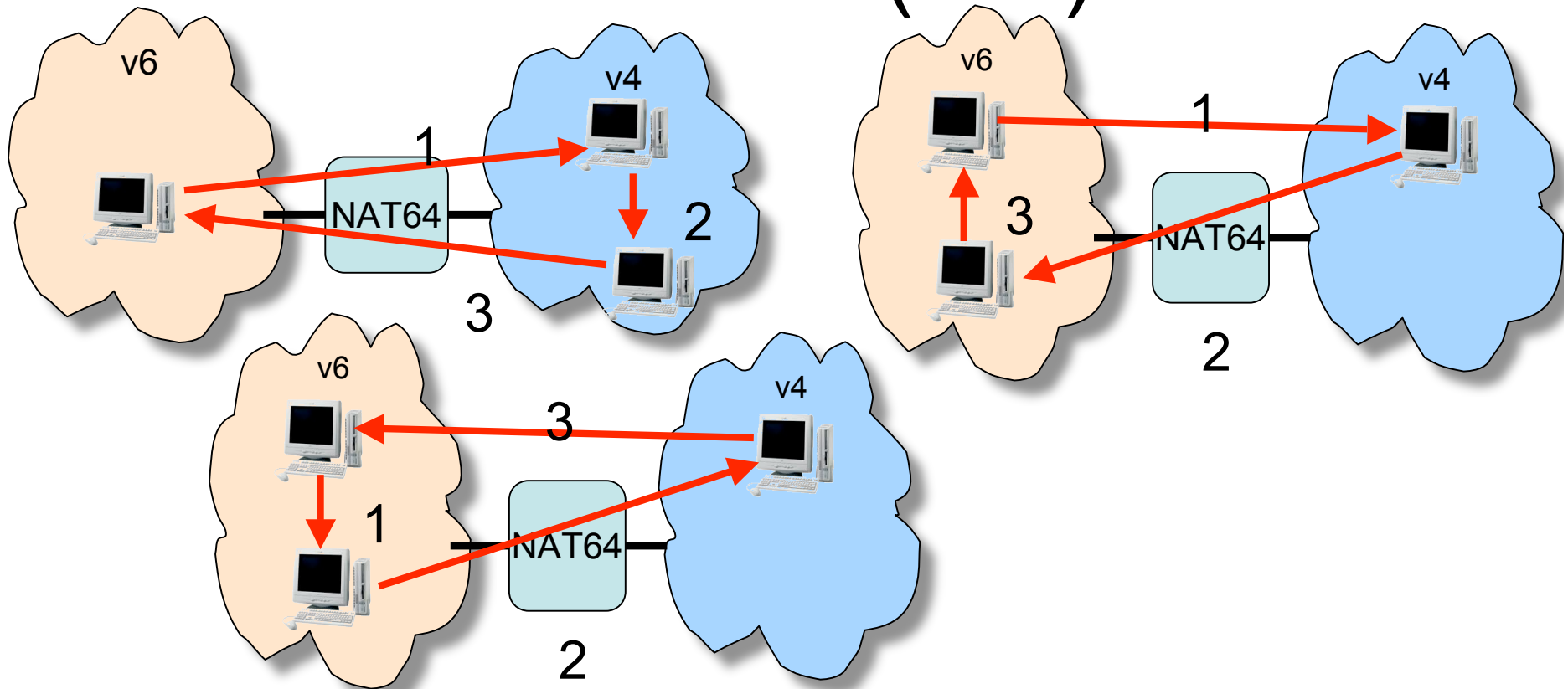

4.4. v6-initiated v4-in-v4 referral

4.5. v6-initiated v4-in-v6 referral

4.6. v6-initiated v6-in-v4 referral

Criteria to decide what application support goal?

- Support only application behaviours supported by traditional NATs?
 - Only v6-initiated short lived local handle?
- Support applications supported by current NAT traversal techniques?

NAT64 required modifications (I)

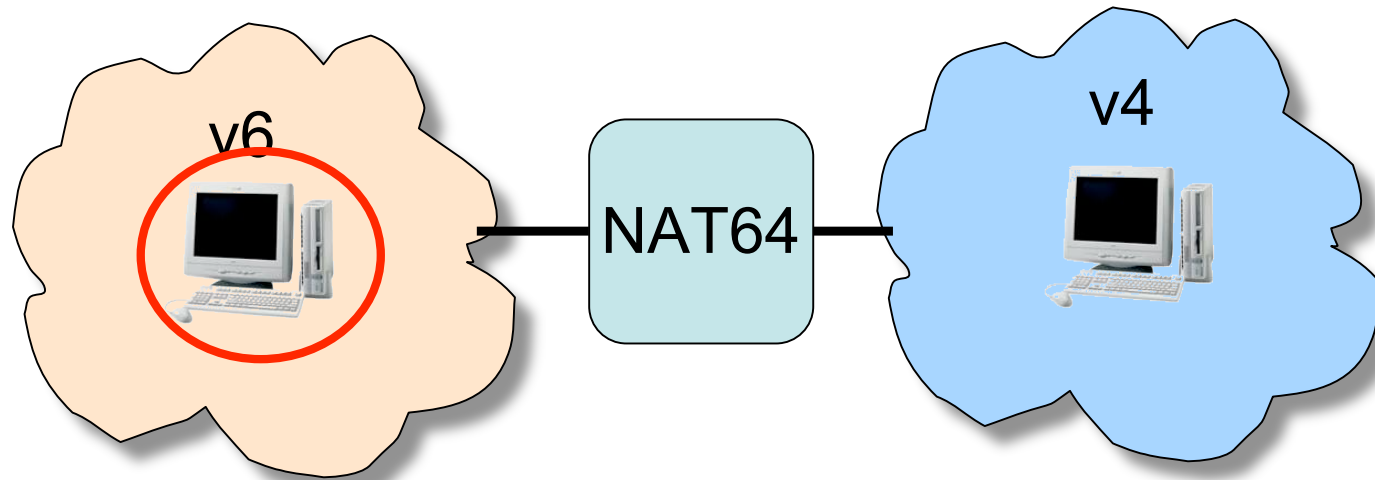

V6 nodes?

NAT64 required modifications (II)

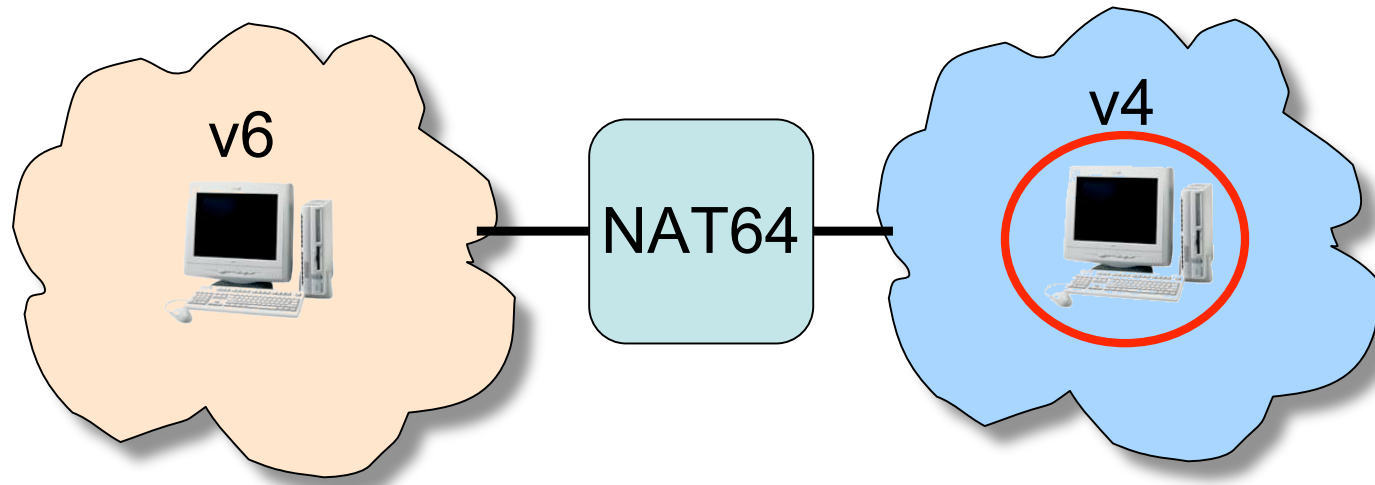

V4 nodes?

NAT64 required modifications (III)

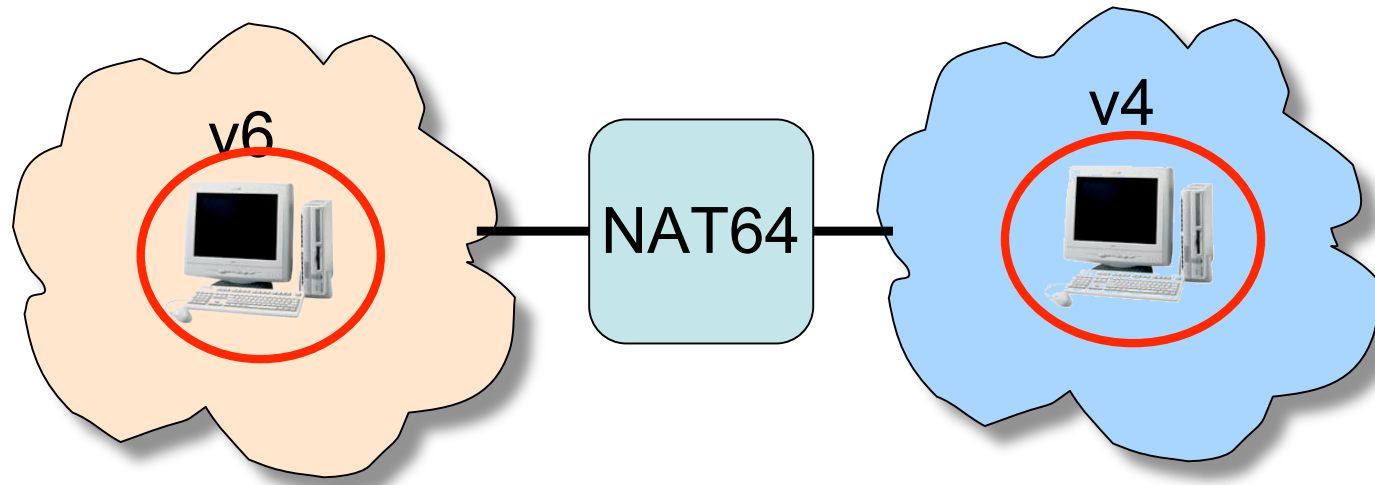

both?

NAT64 required modifications (III)

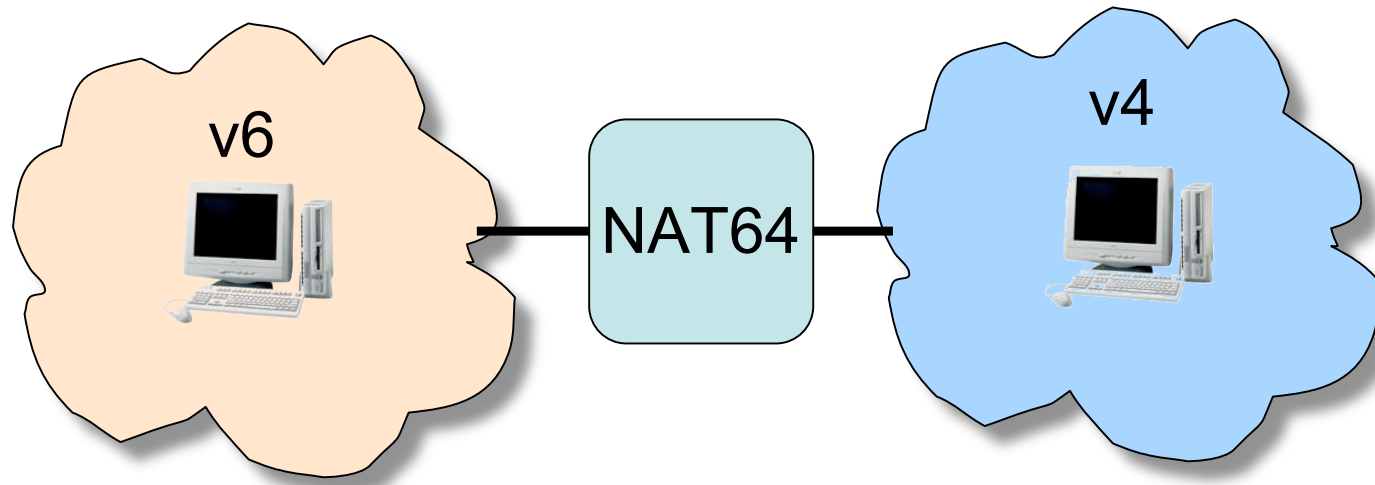

none?

Other considerations

- Application scenario: placement of the NAT64 box
 - In the end site?
 - In the ISP?
- Transparency: NAT64 boxes will be transparent to:
 - V6 nodes
 - V4 nodes
 - Both
 - none