

<b>Question(s):</b>	12	<b>Meeting, date:</b>	15 <sup>th</sup> -19 <sup>th</sup> ,November, 2010, Berlin
<b>Study Group:</b>	15 <b>Working Party:</b>	3	<b>Intended type of document:</b> WD 11 <u>r1</u>
<b>Source:</b>	Editor of G.8110.1		
<b>Title:</b>	Draft Revised G.8110.1 v1.7. <u>45</u>		
<b>Contact:</b>	Italo Busi Alcatel-Lucent Italy	Tel: +39 039 686 7054 Fax: Email: <a href="mailto:italo.busi@alcatel-lucent.com">italo.busi@alcatel-lucent.com</a>	

Please don't change the structure of this table, just insert the necessary information.

This WD contains v1.7.45 of Revised Recommendation G.8110.1.

~~Revision bar marks the editor's proposed changes to v1.7.3 aimed at aligning the draft with the latest versions of IETF RFCs and I.Ds.:~~

Revision bar marks the changes to v1.7.4.

## **Draft revised ITU-T Recommendation G.8110.1/Y.1370.1**

### **Architecture of MPLS Transport Profile (MPLS-TP) layer network**

#### **Summary**

This Recommendation provides functional components, based on [ITU-T G.805], that allow Multi-Protocol Label Switching (MPLS) Transport Profile (MPLS-TP) to be modelled in a way that is consistent with the description of other transport technologies (e.g. Synchronous Digital Hierarchy (SDH), Optical Transport Network (OTN)) defined by the ITU-T to simplify integration with other transport technologies.

This Recommendation complies with the transport profile of MPLS Architecture as defined by the IETF. In the event of a difference between this ITU-T Recommendation and any of the normatively referenced IETF RFCs, the RFCs will take precedence.

In this Recommendation the architecture of MPLS-TP forwarding, Operation, Administration and Maintenance (OAM) and network survivability is modelled from a network-level viewpoint. The description of the control plane and management plane aspects of MPLS-TP is outside the scope of this Recommendation.

The functional components described in this Recommendation also support the architecture for point-to-multipoint (p2mp) MPLS-TP Label Switched Paths (LSPs) in compliance with [IETF RFC 5331] and [IETF RFC 5332].

## CONTENTS

1	Scope.....	5
2	References.....	6
3	Definitions .....	8
4	Abbreviations.....	9
5	Conventions .....	12
6	Functional architecture of MPLS Transport Profile (MPLS-TP) networks .....	12
6.1	MPLS-TP Network layered structure .....	13
6.1.1	MPLS-TP Adapted Information (MT_AI) .....	14
6.1.2	MPLS-TP Characteristic Information .....	15
6.2	MPLS-TP Layer Network .....	15
6.2.1	MPLS-TP Topological Components .....	17
6.2.2	MPLS-TP Transport Entities .....	18
6.2.3	MPLS-TP Transport Processing Functions .....	18
6.2.4	MPLS-TP Reference Points .....	19
6.3	MPLS-TP Layer Network Partitioning .....	20
6.4	MPLS-TP network topology .....	20
6.4.1	Unidirectional and bidirectional connections and trails .....	20
6.4.2	Point-to-multipoint connections and trails .....	20
6.5	MPLS-TP Label Behaviour .....	23
6.5.1	MPLS Label values .....	24
6.5.2	Label Manager.....	24
6.5.3	Labels for p2mp LSPs .....	24
7	Server/client associations.....	24
7.1	MT/client adaptation .....	24
7.1.1	MT/ETH adaptation.....	24
7.2	MT/MT adaptation .....	25
7.3	Server/MT adaptation.....	26
8	MPLS-TP OAM Architecture.....	27
8.1	General .....	28
8.1.1	Management and Control communications.....	28
8.1.2	Server/client interaction.....	28
8.1.3	MPLS-TP maintenance entity groups .....	28
8.2	MPLS-TP connection and trail supervision .....	30

8.2.1	Inherent monitoring .....	30
8.2.2	Non-intrusive monitoring .....	30
8.2.3	Intrusive monitoring .....	30
8.2.4	Trail monitoring.....	31
8.2.5	Sublayer monitoring .....	31
8.3	MPLS-TP Maintenance Entity Group monitoring .....	32
8.3.1	Pro-active monitoring .....	32
8.3.2	On-demand monitoring .....	32
8.4	MPLS-TP MIP.....	33
8.5	Bandwidth considerations with MPLS-TP OAM.....	33
9	MPLS-TP survivability techniques.....	34
10	MPLS-TP Diff-Serv Architecture.....	34
10.1.1	Short-Pipe Model.....	35
10.1.2	Uniform Model.....	35
11	MPLS-TP TTL Behaviour .....	36
12	Security aspects .....	36
<b>Annex A</b>	.....	37
Default configuration options for MPLS-TP in transport networks .....		37
<b>Appendix I</b> .....		39
An example of MPLS-TP layer structure .....		39
Bibliography.....		46

## Draft revised ITU-T Recommendation G.8110.1/Y.1370.1

### Architecture of MPLS Transport Profile (MPLS-TP) Layer Network

Document History	
Issue	Notes
<a href="#">1.7.5</a>	<a href="#">Draft – Updated at November 2010 Q12/15 interim meeting in Berlin</a>
1.7.4	Draft – Input to the November 2010 Q12/15 interim meeting in Berlin
1.7.3	Draft – Updated at June 2010 SG15 plenary meeting in Geneva
1.7.2	Draft – Updated at April 2010 Q12/15 interim meeting in Stockholm
1.7.1	Draft – Updated during drafting at October 2009 SG15 plenary meeting in Geneva and after editorial clean up. Further updates, aimed at describing support of p2mp MPLS-TP LSPs via normative references to RFC 5331 and RFC 5332 avoiding normative references to draft-ietf-mpls-tp-p2mp-framework (in line with the outcome of the discussion at the IETF weekly call on 23 February 2010).
1.7	Draft – Updated after MEAD review
1.6	Draft – Updated after the first MEAD team call
1.5.3	Draft – Updated after discussion with IETF&MEAD team experts
1.5.2	Draft – Updated Editor’s proposal to address the comments from IETF&MEAD team experts
1.5.1	Draft – Editor’s proposal to address the first set of comments from IETF&MEAD team experts
1.4	Draft – Input to the IETF&MEAD team experts review
1.3	Draft – Output of the May 2009 Q12/15 interim meeting in Sophia Antipolis Note – Appendix II has not been yet updated. This update will be done via correspondence.
1.2	Draft – Input to the May 2009 Q12/15 interim meeting in Sophia Antipolis Editor’s proposal for aligning G.8110.1 with the IETF MPLS-TP Architecture and Framework
1.1	Draft – Output of the April 2006 interim meeting in Kobe
1.0	Initial version

## 1 Scope

This Recommendation provides functional components, based on [ITU-T G.805] that allow MPLS-TP to be modelled in a way that is consistent with the description of other transport technologies (e.g. SDH, OTN) defined by the ITU-T.

This Recommendation complies with the transport profile of MPLS Architecture as defined by the IETF in [IETF RFC 5921], [IETF [tp-uni-nni](#)] and [IETF RFC 5960]. Further details of the MPLS-TP architecture are provided by other framework documents such as [IETF [tp-oam-fw](#)], [b-IETF [tp-surv-fw](#)], [b-IETF RFC 5950] and [b-IETF [tp-cp-fw](#)]. In the event of a difference between this ITU-T Recommendation and any of the normatively referenced IETF RFCs, the RFCs will take precedence.

The architecture of MPLS-TP forwarding, OAM and network survivability is modelled from a network-level viewpoint. The description of the control plane and management plane aspects of MPLS-TP is outside the scope of this Recommendation.

The functional components described in this Recommendation also support the architecture for p2mp MPLS-TP LSPs in compliance with [IETF RFC 5331] and [IETF RFC 5332].

NOTE – Further details for the support of p2mp connections (LSPs and PWs) within MPLS-TP are under development in IETF.

As MPLS-TP is a profile of MPLS, this Recommendation uses the applicable functional components provided in the MPLS Layer Network Architecture of [ITU-T G.8110] and extends them with additional capabilities (e.g. OAM and protection) that are not modelled in [ITU-T G.8110].

MPLS-TP is a connection-oriented packet-switched transport layer network technology that uses MPLS-TP LSPs and PWs. MPLS-TP is a profile of MPLS that supports deployment in transport networks and allows consistent operations with other transport technologies. MPLS-TP operates independently of its client and server layer networks. Its operation is also independent of the mechanisms used for configuration and management.

This version of this Recommendation only provides those functional components (based on G.805) and architectural models required to model an Ethernet service carried by a Single-Segment Pseudowire (PW) (SS-PW) over co-routed bi-directional LSPs, which may be hierarchical. It also provides functional component (based on G.805) and architectural models required to model point-to-point and point-to-multipoint unidirectional LSPs.

Other clients for LSPs (e.g. Internet Protocol (IP)) and PWs and modes of operation (e.g. Multi-Segment Pseudowire (MS-PW), associated bi-directional LSPs) as described in [IETF RFC 5921] are supported as defined in [IETF RFC 5921] and [IETF [tp-uni-nni](#)] but are not modelled in this version of the Recommendation. Models for other clients will be added in future versions of this Recommendation.

## 2 References

The following ITU-T Recommendations and other references contain provisions which, through reference in this text, constitute provisions of this Recommendation. At the time of publication, the editions indicated were valid. All Recommendations and other references are subject to revision; users of this Recommendation are therefore encouraged to investigate the possibility of applying the most recent edition of the Recommendations and other references listed below. A list of the currently valid ITU-T Recommendations is regularly published. The reference to a document within this Recommendation does not give it, as a stand-alone document, the status of a Recommendation.

- [ITU-T G.805] ITU-T Recommendation G.805 (2000), *Generic functional architecture of transport networks*.
- [ITU-T G.806] ITU-T Recommendation G.806 (2009), *Characteristics of transport equipment – Description methodology and generic functionality*.
- [ITU-T G.808.1] ITU-T Recommendation G.808.1 (2006), *Generic protection switching – Linear trail and subnetwork protection*.
- [ITU-T G.8010] ITU-T Recommendation G.8010/Y.1306 (2004), *Architecture of Ethernet layer networks*.
- [ITU-T G.8080] ITU-T Recommendation G.8080/Y.1304 (2006), *Architecture for the automatically switched optical network (ASON)*.
- [ITU-T G.8110] ITU-T Recommendation G.8110/Y.1370 (2005), *MPLS layer network architecture*.

- [ITU-T G.7712] ITU-T Recommendation G.7712/Y.1703 (2010), *Architecture and specification of data communication network*.
- [ITU-T X.731] ITU-T Recommendation X.731 (1992), *Information technology – Open Systems Interconnection – Systems Management: State management function*.
- [ITU-T Y.1415] ITU-T Recommendation Y.1415 (2005), *Ethernet-MPLS network interworking – User plane interworking*.
- [IETF RFC 3031] IETF RFC 3031 (2001), *Multiprotocol label switching architecture*.
- [IETF RFC 3032] IETF RFC 3032 (2001), *MPLS label stack encoding*.
- [IETF RFC 3270] IETF RFC 3270 (2002), *Multi-Protocol Label Switching (MPLS) Support of Differentiated Services*.
- [IETF RFC 3443] IETF RFC 3443 (2003), *Time To Live (TTL) Processing in Multi-Protocol Label Switching (MPLS) Networks*.
- [IETF RFC 4385] IETF RFC 4385 (2006), *Pseudowire Emulation Edge-to-Edge (PWE3) Control Word for Use over an MPLS PSN*.
- [IETF RFC 4448] IETF RFC 4448 (2006), *Encapsulation Methods for Transport of Ethernet over MPLS Networks*.
- [IETF RFC 4720] IETF RFC 4720 (2006), *Pseudowire Emulation Edge-to-Edge (PWE3) – Frame Check Sequence Retention*.
- [IETF RFC 4875] IETF RFC 4875 (2007), *Extensions to Resource Reservation Protocol - Traffic Engineering (RSVP-TE) for Point-to-Multipoint TE Label Switched Paths (LSPs)*.
- [IETF RFC 5331] IETF RFC 5331 (2008), *MPLS Upstream Label Assignment and Context-Specific Label Space*.
- [IETF RFC 5332] IETF RFC 5332 (2008), *MPLS Multicast Encapsulations*.
- [IETF RFC 5462] IETF RFC 5462 (2009), *Multiprotocol Label Switching (MPLS) Label Stack Entry: "EXP" Field Renamed to "Traffic Class" Field*.
- [IETF RFC 5586] IETF RFC 5586 (2009), *MPLS Generic Associated Channel*.
- [IETF RFC 5718] IETF RFC 5718 (2010), *An Inband Data Communication Network For the MPLS Transport Profile*.
- [IETF RFC 5654] IETF RFC 5654 (2009), *MPLS-TP Requirements*.
- [IETF RFC 5860] IETF RFC 5860 (2010), *Requirements for Operations, Administration, and Maintenance (OAM) in MPLS Transport Networks*.
- [IETF RFC 5921] IETF RFC 5921(2010), *A Framework for MPLS in Transport Networks*.
- [IETF [tp-uni-nni](#)] IETF Internet Draft [draft-ietf-mpls-tp-uni-nni-00.txt](#) (2010), *MPLS Transport Profile User-to-Network and Network-to-Network Interfaces*.
- [IETF RFC 5960] IETF RFC 5960 (2010), *MPLS Transport Profile Data Plane Architecture*, plus Errata 2533 (2010) [and Errata 2534 \(2010\)](#).
- [IETF [tp-ident](#)] IETF [Internet Draft draft-ietf-mpls-tp-identifiers-03.txt](#) (2010), *MPLS-TP Identifiers*.
- [IETF [tp-oam-fw](#)] IETF [Internet Draft draft-ietf-mpls-tp-oam-framework-09.txt](#) (2010), *MPLS-TP OAM Framework and Overview*.

~~[IETF [tp-surv-fw](#)] IETF Internet Draft [draft-ietf-mpls-tp-survive-fwk-06.txt](#) (2010), *Multiprotocol Label Switching Transport Profile Survivability Framework*.~~

~~[Editor's note – The I D [draft-ietf-mpls-tp-survive-fwk-06](#) is currently in the RFC Editor Queue but it has not yet been approved by ITU-T]~~

[Editor's note – Update the references to reference the approved IETF RFCs on MPLS-TP when available]

### 3 Definitions

This Recommendation uses the following terms defined in [ITU-T G.805]:

- 3.1 access point
- 3.2 adapted information
- 3.3 administrative domain
- 3.4 characteristic information
- 3.5 client/server relationship
- 3.6 connection
- 3.7 connection point
- 3.8 connection supervision
- 3.9 layer network
- 3.10 link
- 3.11 link connection
- 3.12 network
- 3.13 network connection
- 3.14 reference point
- 3.15 sublayer
- 3.16 subnetwork
- 3.17 subnetwork connection
- 3.18 tandem connection
- 3.19 termination connection point
- 3.20 trail
- 3.21 trail termination
- 3.22 transport
- 3.23 transport entity
- 3.24 transport processing function
- 3.25 unidirectional connection

This Recommendation uses the following terms defined in [IETF RFC 3031]:

- 3.26 label



**3.27** label stack

**3.28** label switched path

**3.29** MPLS label stack

This Recommendation uses the following terms defined in [IETF RFC 3032]:

**3.30** bottom of stack

**3.31** label value

**3.32** time to live

This Recommendation uses the following terms defined in [IETF RFC 3270]:

**3.33** label inferred PHB scheduling class LSP

**3.34** per hop behaviour

This Recommendation uses the following terms defined in [IETF RFC 5462]:

**3.35** Explicitly TC-encoded-PSC LSP

**3.36** traffic class

This Recommendation uses the following terms defined in [IETF RFC 5586]:

**3.37** Associated Channel Header

**3.38** Generic Associated Channel

**3.39** G-ACh packet

**3.40** G-ACh packet payload

This Recommendation uses the following terms defined in [ITU-T G.808.1]:

**3.41** network survivability

**3.42** protection

**3.43** restoration

This Recommendation uses the following terms defined in [ITU-T X.731]:

**3.44** administrative state

This Recommendation uses the following terms defined in [ITU-T G.8010]:

**3.45** maintenance entity group

**3.46** maintenance entity

**3.47** maintenance entity group intermediate point compound function

**3.48** pro-active monitoring

**3.49** on-demand monitoring

This Recommendation uses the following terms defined in [IETF RFC 5921]:

**3.50** MPLS Transport Profile (MPLS-TP)

**3.51** Pseudowire

## **4 Abbreviations**

This Recommendation uses the following abbreviations:

ACH	Associated Channel Header
AI	Adapted Information
AP	Access Point
APS	Automatic Protection Switching <sup>1</sup>
CI	Characteristic Information
CII	Common Interworking Indicators
CW	Control Word
CO-PS	Connection-Oriented Packet Switched
CP	Connection Point
D	Data (i.e., traffic unit)
DE	Drop Eligibility
ECC	Embedded Communication Channels <sup>2</sup>
ECMP	Equal Cost Multi-Path
E-LSP	Explicitly TC-encoded-PSC LSP
ETH	Ethernet MAC layer network
FP	Flow Point
GAL	Generic Associated Channel (G-ACh) Label
G-ACh	Generic Associated Channel
IP	Internet Protocol
iPHB	Incoming Per Hop Behaviour
LC	Link Connection
L-LSP	Label-Only-Inferred PSC LSP
LSE	Label Stack Entry
LSP	Label Switched Path
ME	Maintenance Entity
MEG	Maintenance Entity Group
MEP	Maintenance entity group End Point
MIP	Maintenance entity group Intermediate Point
MPLS	Multi-Protocol Label Switching
MPLS-TP	Multi-Protocol Label Switching – Transport Profile
MS-PW	Multi-Segment Pseudowire
MT	Multi-Protocol Label Switching – Transport Profile

---

<sup>1</sup> The IETF has not yet selected a term for this set of functions.

<sup>2</sup> The IETF uses the term CCh

MTD	MPLS-TP Diagnostic function
MTDi	MPLS-TP Diagnostic function within MT MIP
MTS	MPLS-TP Section
NC	Network Connection
NE	Network Element
NSP	Native Service Processing
NMS	Network Management System
OAM	Operation, Administration and Maintenance
ODU	Optical channel data unit
oPHB	Outgoing Per Hop Behaviour
OTH	Optical Transport Hierarchy
OTN	Optical Transport Network
p2mp	point-to-multipoint
p2p	point-to-point
P	Priority
PHB	Per Hop Behaviour
PHP	Penultimate Hop Popping
PSC	PHB Scheduling Class
PW	Pseudowire
S-bit	Bottom of Stack Indicator
SCN	Signalling Communication Network
SDH	Synchronous Digital Hierarchy
Sk	Sink
SN	Subnetwork
SNC	Subnetwork Connection
SNC/S	SNCP with Sublayer monitoring
SNCP	Subnetwork Connection Protection
So	Source
SPME	Sub-Path Maintenance Element
SSF	Server Signal Fail <sup>3</sup>
SS-PW	Single-Segment Pseudowire
TC	Traffic Class
TCM	Tandem Connection Monitoring

---

<sup>3</sup> The IETF has not yet selected a term for this abstract information element.

TCP	Termination Connection Point
TSD	Trail Signal Degrade
TSF	Trail Signal Fail
TT	Trail Termination
TTL	Time-To-Live
VC	Virtual Container

## 5 Conventions

The diagrammatic convention for connection-oriented layer networks described in this Recommendation is that of [ITU-T G.805].

All transport entities within this Recommendation are unidirectional unless explicitly specified otherwise.

The diagrammatic conventions for Maintenance Entity (ME) Group (MEG) End Point (MEP) and MEG Intermediate Point (MIP) compound functions are those of [ITU-T G.8010].

## 6 Functional architecture of MPLS Transport Profile (MPLS-TP) networks

The complete architecture of MPLS-TP is defined by the IETF in [IETF RFC 5921] and [IETF [tp-uni-nni](#)]. Further details of the MPLS-TP architecture are provided by other framework documents such as [IETF [tp-oam-fw](#)], [~~b-IETF~~ [tp-surv-fw](#)], [b-IETF RFC 5950], [b-IETF [tp-cp-fw](#)] and [b-IETF [tp-sec-fw](#)].

The requirements for MPLS-TP forwarding, OAM and network survivability are described in [IETF RFC 5654] and [IETF RFC 5860].

The MPLS-TP framework is described in [IETF RFC 5921] and [IETF [tp-uni-nni](#)]. The MPLS-TP OAM framework and architecture is defined in [IETF [tp-oam-fw](#)]. The MPLS-TP protection switching framework and architecture are based on [ITU-T G.808.1] and ~~defined~~ described in [~~b-IETF~~ [tp-surv-fw](#)]. The structure of the identifiers for the transport entities are defined in [IETF [tp-ident](#)].

Control and management plane aspects are outside the scope of this Recommendation.

This Recommendation provides functional components (based on G.805) that allow MPLS-TP to be modelled in a way that is consistent with the description of other transport technologies defined by the ITU-T.

These functional components support the architecture for p2mp MPLS-TP LSPs in compliance with [IETF RFC 5331] and [IETF RFC 5332]. Further details on p2mp MPLS-TP LSPs and PWs are under definition in IETF and future versions of this Recommendation may be updated to include this new material.

The current version of this Recommendation only provides those functional components (based on G.805) and architectural models required to model Ethernet carried by a SS-PW over hierarchical co-routed bi-directional LSPs in the network scenario provided in annex A.

MPLS-TP supports other clients for LSPs (e.g. IP) and PWs, multi-segment PW (MS-PW) and non-DiffServ Traffic Engineered (TE) LSPs as described in [IETF RFC 5921] and [IETF [tp-uni-nni](#)]. Models for these clients and other modes of operations will be added to future versions of this Recommendation.

MPLS-TP conformant equipment may support additional MPLS features. These additional MPLS features are outside the scope of this Recommendation.

## 6.1 MPLS-TP Network layered structure

One layer network is defined in the MPLS-TP network architecture:

- MPLS-TP Layer Network.

The MPLS-TP layer network is a path layer network as defined in clause 6.2 of [ITU-T G.8110].

The MPLS-TP layer network may be deployed recursively to provide an MPLS-TP hierarchy implemented as a label stack as per [IETF RFC 5921]. In this Recommendation, this is described by the use of sub-layering as defined in clause 8.1 of [ITU-T G.8110]. PWs in MPLS-TP can only be carried over MPLS-TP LSPs.

The MPLS architecture does not have a minimum packet length. When MPLS packets are transmitted over a non-MPLS-TP server layer with a minimum frame size, the Server/MPLS-TP adaptation function will pad these packets to the minimum frame size of that non-MPLS-TP server layer. This padding is removed at the adaptation sink of the non-MPLS client. The mechanisms for mapping clients over MPLS-TP provide appropriate information (e.g. the length field in the Control Word) to remove the padding at that MPLS-TP/Client adaptation sink function.

In normal operations, all packets with the same class of service sent over an MPLS-TP connection are delivered in order; see [IETF RFC 5921]. This means that, under normal conditions, all the packets sent over a PW or Explicitly Traffic Class (TC)-encoded Per Hop Behaviour (PHB) Scheduling Class (PSC) LSP (E-LSP) within the same class of service are delivered in order and that all the packets sent over an Label-Only-Inferred PSC LSP (L-LSP) are delivered in order (because L-LSPs support only a single class of service).

NOTE – The mapping of a client over MPLS TP must be handled to respect ordering requirement for the client. Mechanisms to achieve this are client layer specific and outside the scope of this Recommendation.

At domain boundaries, an instance of a layer or sub-layer playing a specific role in one domain may continue in the adjacent domain in another role. Roles describe particular client/server layer relationships. The Characteristic Information (CI) of the layer is the only necessary condition for how the layer continues between domains. In G.805 terms, the server of a client/server relationship in one domain might be a client in the adjacent domain.

As applied to MPLS-TP domains, the layer instances of a MPLS-TP hierarchy may be described in terms of their role in the hierarchy. These roles are channel, path, and section. At a boundary between two domains, an MPLS-TP Section in one domain could continue as an MPLS-TP Path in the adjacent domain. In MPLS-TP the instantiation of a Sub-Path Maintenance Element (SPME) for an LSP creates a new sub-layer but does not change the role of the LSP with respect to the MPLS-TP connection the SPME is associated with.

Figure 6-1 illustrates that LSP2 has a MPLS-TP Path role in Domain 2 and a MPLS-TP Section role in Domain 1.

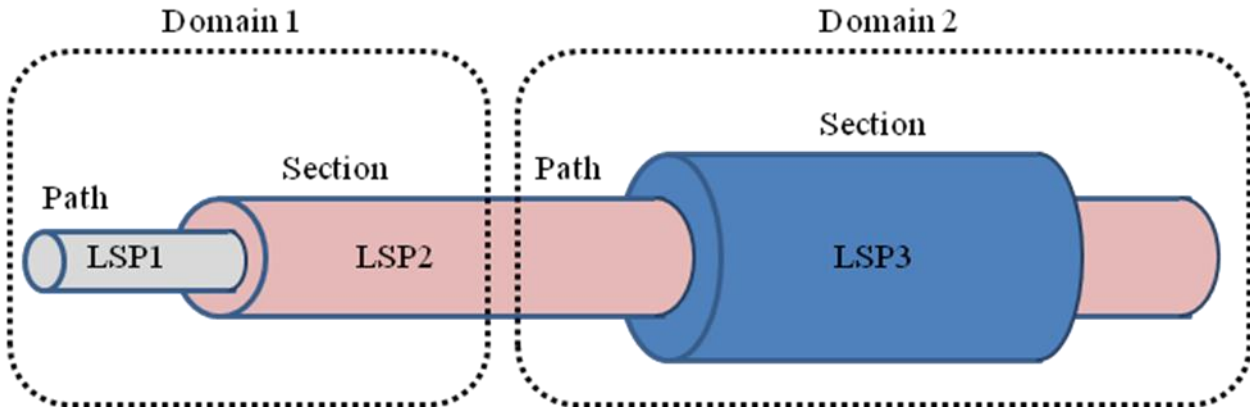
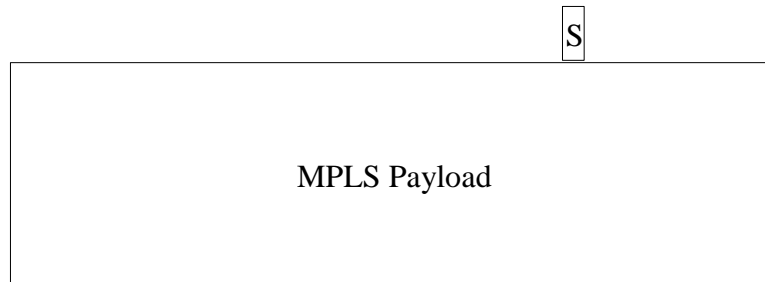

**Figure 6-1 – MPLS-TP roles and layers**

### 6.1.1 MPLS-TP Adapted Information (MT\_AI)

The MPLS-TP layer network adapted information is a flow of MT\_AI Data (MT\_AI\_D) traffic units accompanied by the MT\_AI\_PHB, MT\_AI\_TSD and MT\_AI\_TSF signals.

The MT\_AI traffic unit consists of an MT\_AI header containing the Bottom of Stack Indicator (S-bit) field of the MPLS shim header and an MPLS payload field. [Figure 6-2](#) below provides a graphical representation of the MT\_AI traffic unit format.



**Figure 6-2 – MT\_AI Traffic Unit**

NOTE – The definition of the MT\_AI traffic unit is based on the MPLS\_AI traffic unit as defined in clause 6.2.1 of [ITU-T G.8110].

The MPLS payload field carries either the encapsulated client information or the encapsulated information from communication channels that are associated with the MPLS-TP trail (e.g. Signalling Communication Network (SCN)).

The encapsulated client information is either a PW encapsulated client information (e.g. the Ethernet Service Payload with the Control Word, in case of an Ethernet client utilizing the Generic Associated Channel (G-ACh)), when the client layer network is a PW client, or, in case of MPLS-TP sub-layering, a labelled packet as defined in [IETF RFC 3031].

NOTE – Other clients are not prohibited and are for further study.

The MT\_AI\_PHB signal supports the Diff-Serv Architecture as described in clause 10.

The MT\_AI\_TSF and MT\_AI\_TSD signals are MPLS-TP signal fail and signal degrade indication outputs at the Access Point (AP) of an MPLS-TP termination function as defined in [ITU-T G.806].

### 6.1.2 MPLS-TP Characteristic Information

The MPLS-TP layer network characteristic information is a flow of MT\_CI Data (MT\_CI\_D) traffic units.

The MT\_CI traffic unit (MT\_CI\_D) consists either of a MT\_AI traffic unit (MT\_AI\_D) or of a MPLS-TP OAM traffic unit, extended with an MT\_CI header containing the Time-To-Live (TTL) field of the MPLS shim header. ~~Figure 6-3~~ ~~Figure 6-3~~ below provides a graphical representation of the MT\_CI traffic unit format.

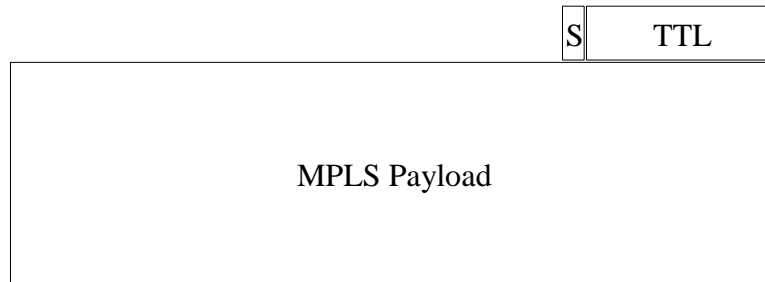

**Figure 6-3 – MT\_CI Traffic Unit**

NOTE – The definition of the MT\_CI traffic unit is based on the MPLS\_CI traffic unit as defined in clause 6.2.2 of [ITU-T G.8110]. In line with [ITU-T G.8110] the MPLS label and TC fields are considered part of the MPLS header but associated with the MPLS-TP link and not with the MPLS\_TP characteristic information.

The MPLS-TP OAM traffic unit contains the MPLS-TP OAM PDU (i.e. a G-ACh packet payload as defined in [IETF RFC 5586]).

In this Recommendation the assignment of the S and TTL fields in the LSP or PW Label Stack Entry (LSE) of a G-ACh packet is defined in the MPLS-TP Trail Termination (MT\_TT) function, the assignment of the other fields is defined in the adaptation function.

Details for the insertion of G-ACh packets into MPLS-TP LSPs and PWs are defined in [IETF RFC 5586]. Note that for PWs, the PWE3 control word [IETF RFC 4385] is required in the encapsulation of user packets when the Associated Channel Header (ACH) is used to realize the associated control channel.

The MT\_CI traffic units (MT\_CI\_D) are accompanied by the MT\_CI\_iPHB, MT\_CI\_oPHB, MT\_CI\_SSF and optional MT\_CI\_APS signals.

The MT\_CI\_iPHB and MT\_CI\_oPHB signals support the Diff-Serv Architecture as described in clause 10.

The MT\_CI\_SSF signal is the MPLS-TP signal fail indication outputs at the Connection Point (CP) of a Server/MPLS-TP adaptation function as defined in [ITU-T G.806].

The MT\_CI\_APS is needed to support linear protection switching mechanisms as defined in [ITU-T G.808.1].

### 6.2 MPLS-TP Layer Network

The MPLS-TP layer network provides the transport of adapted information through a MPLS-TP trail between MPLS-TP access points. The logical association between these points is called a tunnel in the MPLS-TP RFCs. A tunnel is associated with one or more LSPs. The tunnel is one of

the primary constructs that is identified and it is used to identify the LSPs that are associated with it, see [IETF **tp-ident**] for further details.

The MPLS-TP layer network characteristic information is transported over a MPLS-TP network connection. The MPLS-TP layer network contains the following transport processing functions, transport entities, topological components and reference points:

- MPLS-TP trail;
- MPLS-TP trail termination source (MT\_TT\_So);
- MPLS-TP trail termination sink (MT\_TT\_Sk);
- MPLS-TP network connection (MT NC);
- MPLS-TP link connection (MT LC);
- MPLS-TP subnetwork connection (MT SNC);
- MPLS-TP subnetwork (MT SN);
- MPLS-TP link;
- MPLS-TP access point (MT AP);
- MPLS-TP connection point (MT CP);
- MPLS-TP termination connection point (MT TCP).

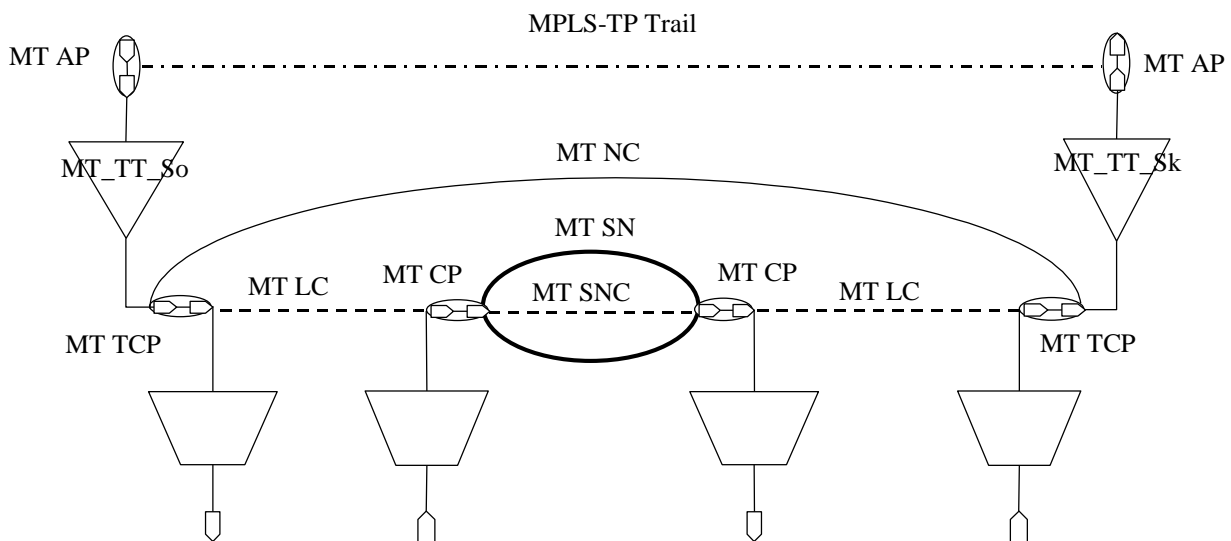

**Figure 6-4 – MPLS-TP layer network example**

Figure 6-5 depicts the MPLS-TP layer network structure when carrying an Ethernet client using a SS-PW over an LSP. When LSPs are nested the server trail in Figure 6-5 will be another MPLS-TP trail.



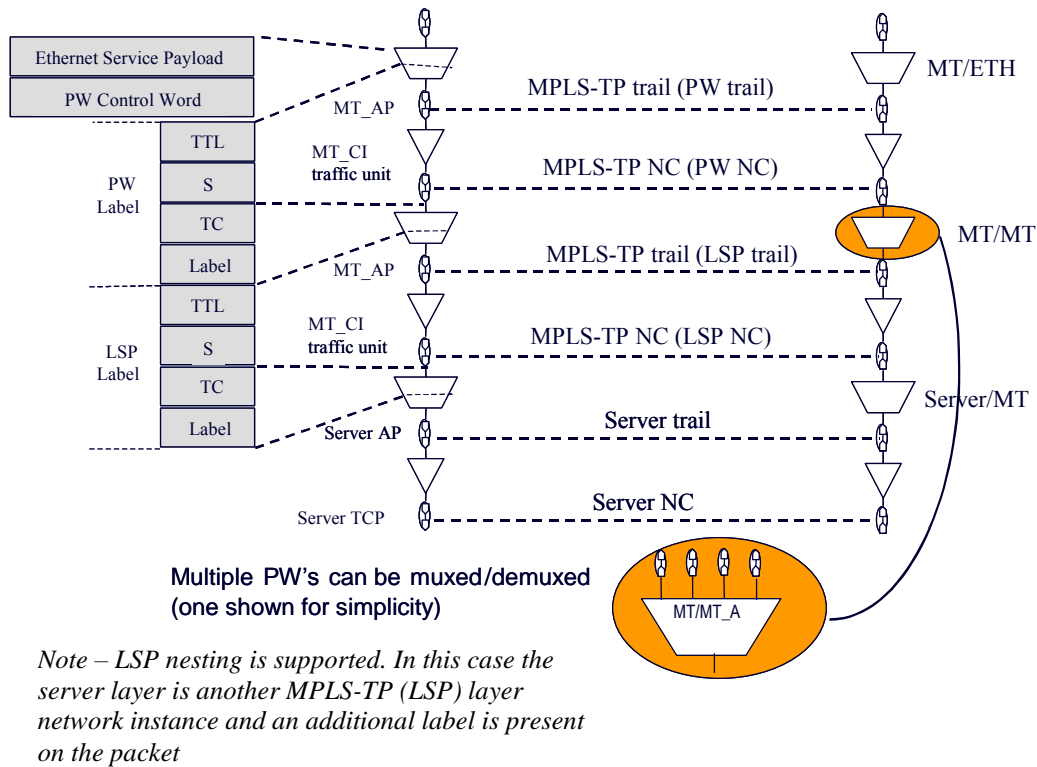

**Figure 6-5 – MPLS-TP layer network structure example**

### 6.2.1 MPLS-TP Topological Components

The MPLS-TP topological components are defined in clause 8.1.1 of [ITU-T G.8110]:

- MPLS-TP layer network;
- MPLS-TP subnetwork;
- MPLS-TP link;
- MPLS-TP access group.

#### 6.2.1.1 MPLS-TP Layer Network

The MPLS-TP layer network is defined by the complete set of MPLS-TP access groups that may be associated for the purpose of transferring information as defined in clause 8.1.1.1 of [ITU-T G.8110].

#### 6.2.1.2 MPLS-TP Subnetwork

An MPLS-TP subnetwork is defined by the set of MPLS-TP connection points that are available for the purpose of transferring information as defined in clause 8.1.1.2 of [ITU-T G.8110].

#### 6.2.1.3 MPLS-TP Link

A MPLS-TP link consists of a subset of the MPLS-TP connection points at the edge of one MPLS-TP subnetwork or MPLS-TP access group that are associated with a corresponding subset of MPLS-TP connection points at the edge of another MPLS-TP subnetwork or MPLS-TP access group for the purpose of transferring MPLS-TP characteristic information as defined in clause 8.1.1.3 of [ITU-T G.8110].

#### **6.2.1.4 MPLS-TP Access Group**

A MPLS-TP access group is a group of collocated MPLS-TP trail termination functions that are connected to the same MPLS-TP subnetwork or MPLS-TP link.

#### **6.2.2 MPLS-TP Transport Entities**

The MPLS-TP transport entities are:

- MPLS-TP link connection;
- MPLS-TP network connection;
- MPLS-TP subnetwork connection;
- MPLS-TP trail.

#### **6.2.3 MPLS-TP Transport Processing Functions**

The MPLS-TP transport processing functions are:

- MPLS-TP trail termination function;
- MPLS-TP/client layer network adaptation functions.

##### **6.2.3.1 MPLS-TP Trail Termination**

The bidirectional MPLS-TP trail termination (MT\_TT) function is performed by a collocated pair of associated unidirectional MPLS-TP trail termination source (MT\_TT\_So) and sink (MT\_TT\_Sk) functions.

The MPLS-TP trail termination source (MT\_TT\_So) performs the following processes between its input and output:

- inserts the 8-bit TTL field;
- inserts MPLS-TP OAM traffic units extended with an MT\_CI header (as defined in clause 6.1.2);
- outputs the resulting MT\_CI.

The MPLS-TP trail termination sink (MT\_TT\_Sk) performs the following functions between its input and output:

- extracts and processes MPLS-TP OAM traffic units;
- extracts the 8-bit TTL field;
- outputs the resulting MT\_AI.

##### **6.2.3.2 MPLS-TP to client layer network adaptation functions**

For the case when the client packets need to be forwarded to different destinations (based for example on configuration or on destination information in the client layer packets), the client traffic unit is delivered to different Connection Point/Flow Point (CP/FP) in the client layer network. The selection of the client layer CP/FP is in the scope of the client layer network and outside the scope of this Recommendation.

For the case of packet clients that include QoS information in each frame the MT/client adaptation function may support more than one access point. The access point is selected per frame based on the QoS information contained in the client layer. The QoS information is passed across the access point as AI\_PHB parameter. The description of Diff-Serv support in MPLS-TP is provided in section 10.

For example, as defined in [IETF RFC 4448], it is possible that the traffic sent on a single client CP/FP is delivered to:

- 1) different PWs (one per each class of service of the client layer transport entity) where each of them is carried by different L-LSPs supporting the same CoS as the carried PW: in this case the MT/Client\_A function has different APs (one per CoS) and the MT/MT\_A function has one AP;
- 2) one PW, supporting all the classes of service of the client layer transport entity, that is then carried over an E-LSP supporting at least all the classes of service of the carried PW: in this case both the MT/Client\_A and the MT/MT\_A functions have a single AP;
- 3) one PW, supporting all the classes of service of the client layer transport entity, that is then carried over different L-LSPs (one for each class of service of the carried PW): in this case the MT/Client\_A function as a single AP while the MT/MT\_A function has different APs (one per CoS).

These examples are described in Figure 6-6.

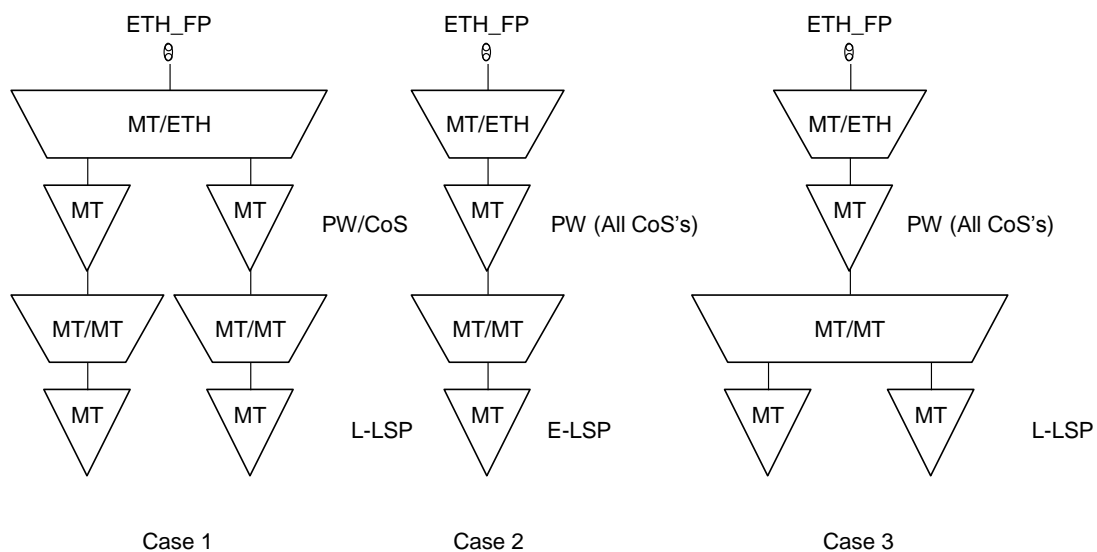

**Figure 6-6 – Examples of QoS processing in MT/Client\_A function**

The MPLS-TP/client adaptation functions are described in clause 7.

#### 6.2.4 MPLS-TP Reference Points

The MPLS-TP reference points are defined in clause 8.1.4 of [ITU-T G.8110]:

- MPLS-TP access point (MT AP);
- MPLS-TP connection point (MT CP);
- MPLS-TP termination connection point (MT TCP).

##### 6.2.4.1 MPLS-TP Access Point

A MPLS-TP access point (MT AP) represents the binding between a MPLS-TP trail termination function and one or more MT/client, or MT/MT, adaptation functions as defined in clause 8.1.4.1 of [ITU-T G.8110].

##### 6.2.4.2 MPLS-TP Connection Point

A MPLS-TP link connects to a MPLS-TP subnetwork or another MPLS-TP link via a MPLS-TP connection point (MT CP) as defined in clause 8.1.4.2 of [ITU-T G.8110].

### **6.2.4.3 MPLS-TP Termination Connection Point**

A MPLS-TP termination connection point (MT TCP) connects a MPLS-TP trail termination (MT\_TT) function with a MPLS-TP link as defined in clause 8.1.4.3 of [ITU-T G.8110].

### **6.3 MPLS-TP Layer Network Partitioning**

The description of MPLS-TP layer network partitioning is the same as clause 8.2 of [ITU-T G.8110].

### **6.4 MPLS-TP network topology**

An MPLS-TP layer network contains zero or more MT links and zero or more MT subnetworks.

MPLS-TP layers can support unidirectional and bidirectional point-to-point connections, and unidirectional point-to-multipoint connections between two or more connection points and/or termination connection points at the edges of the MPLS-TP layer network administrative domain.

This version of the Recommendation supports the following MPLS-TP connections, as defined in [IETF RFC 5921] and [IETF RFC 4875]:

- point-to-point single-segment PW (SS-PW)
- point-to-point unidirectional and co-routed bi-directional LSPs
- point-to-multipoint unidirectional LSPs

NOTE – [IETF RFC 4875] defines the p2mp LSPs as well as control plane aspects for setting up p2mp LSPs using RSVP-TE signalling. Additional description of p2mp LSPs is provided in [b-IETF RFC 4461].

Point-to-multipoint PWs are outside the scope of this version of the Recommendation.

The control plane aspects are out of the scope of this Recommendation.

#### **6.4.1 Unidirectional and bidirectional connections and trails**

A bidirectional connection in a server layer network may support either bidirectional or unidirectional MPLS-TP connections, but a unidirectional connection in the server layer network may only support unidirectional MPLS-TP connections.

#### **6.4.2 Point-to-multipoint connections and trails**

A unidirectional point-to-multipoint network connection broadcasts the traffic from the root MPLS-TP TCP to the leaf MPLS-TP TCPs as illustrated in Figure 6-7.

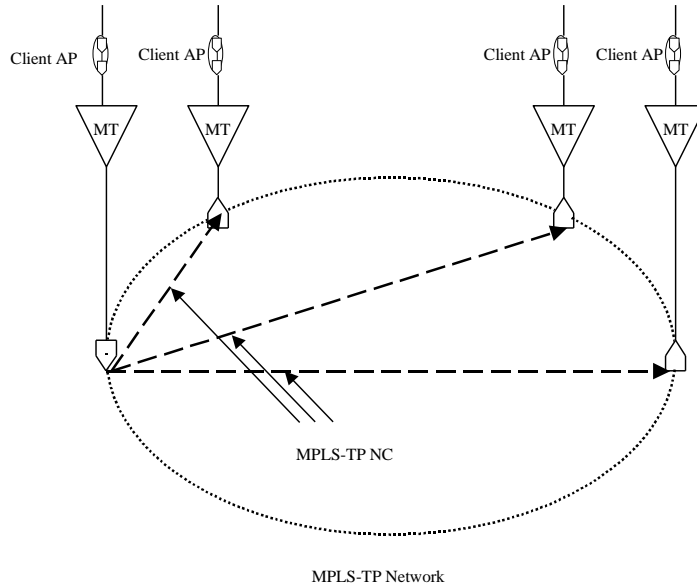

**Figure 6-7 – Point-to-multipoint MPLS-TP connection**

A point-to-multipoint MPLS-TP network connection can be decomposed into point-to-multipoint MPLS-TP subnetworks connections and point-to-point (p2p) MPLS-TP link connections as shown in Figure 6-8.

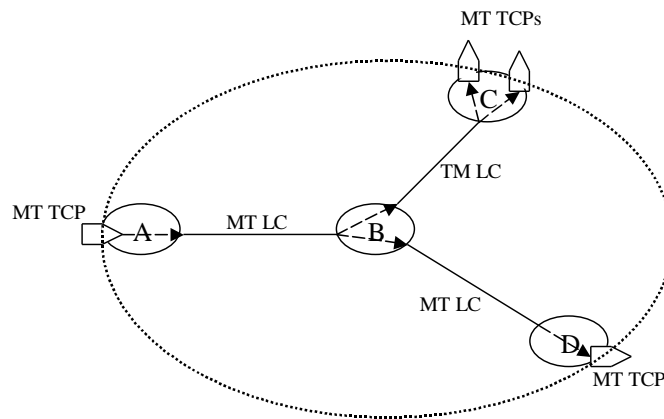
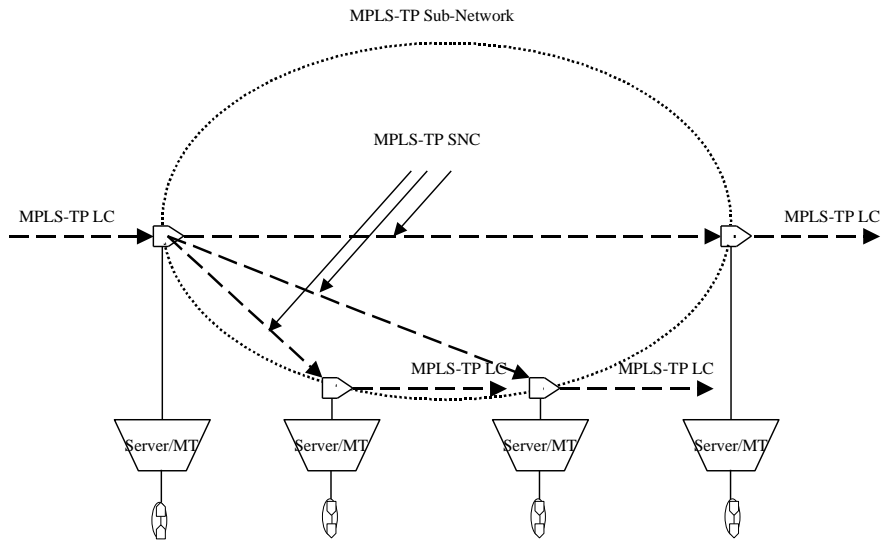

**Figure 6-8 – MPLS-TP p2mp network connection using MPLS-TP p2p link connections**

Subnetwork A will send a single copy of the traffic units from the MT TCP to the downstream subnetwork B via a point-to-point MPLS-TP LC. Subnetwork B performs traffic unit replication sending one copy of the traffic unit to the downstream subnetwork C and another copy to the downstream subnetwork D via two different point-to-point MPLS-TP link connections. Subnetwork D will send the received traffic unit to its MPLS-TP TCP while subnetwork C performs traffic unit replication toward two MPLS-TP TCPs.

A unidirectional point-to-multipoint subnetwork connection broadcasts the traffic from the root MPLS-TP CP to the leaf MPLS-TP CPs as illustrated in Figure 6-9. The broadcast function provided by the point-to-multipoint subnetwork connection is limited to the subnetwork in which it

exists. It may form part of a broadcast function within a larger (containing) subnetwork or network connection.



*Note: The server layer could also be MPLS-TP*

**Figure 6-9 – Point-to-multipoint MPLS-TP subnetwork connection**

A point-to-multipoint MPLS-TP network connection can be decomposed into point-to-multipoint MPLS-TP subnetworks connections and point-to-multipoint MPLS-TP link connections as shown in Figure 6-10.

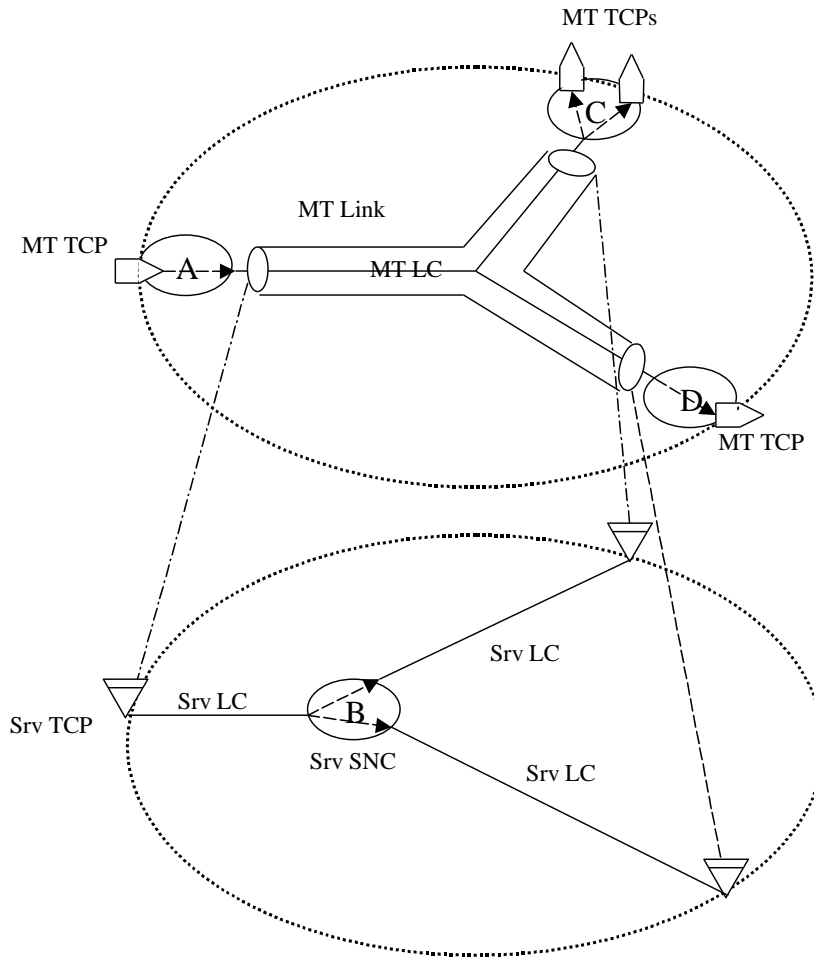

**Figure 6-10 – MPLS-TP p2mp network connection using MPLS-TP p2mp link connection**

Subnetwork A will send a single copy of the traffic units from the MT TCP to the downstream subnetworks C and D via a point-to-multipoint MPLS-TP LC.

The server layer supporting the point-to-multipoint MPLS-TP link can be any MPLS-TP server layer (as defined in clause 7.3 or another MPLS-TP server layer network instance). Server layer subnetwork B performs traffic unit replication in the server layer delivering one copy of the traffic unit to the downstream MPLS-TP subnetwork C and another copy to the downstream MPLS-TP subnetwork D.

Subnetwork D will send the received traffic unit to its MPLS-TP TCP while subnetwork C performs traffic unit replication toward two MPLS-TP TCPs.

When a point-to-multipoint Link is used, the link connection always matches the topology of the link. If the required connectivity is less than the one provided by the point-to-multipoint link, traffic units delivered at some of the link ends will be discarded by the Server/MT\_A\_Sk function. This could result in wasting of bandwidth resources on some links.

### 6.5 MPLS-TP Label Behaviour

The allocation of the label space is described in [IETF RFC 3031], [IETF RFC 3032], [IETF RFC 5331] and [IETF RFC 5332]. Per-platform, per-interface and context-specific label spaces are

supported by MPLS-TP as specified in [IETF RFC 5921] and [IETF RFC 5331]. The mechanisms for label allocation are outside the scope of this Recommendation.

### **6.5.1 MPLS Label values**

[IETF RFC 3032] reserves the use of label values 0-15 for specific purposes. The reserved MPLS label values are managed by the Internet Assigned Numbers Authority (IANA) that will allocate MPLS Labels from the set of reserved Label values through the IETF consensus process.

Further information on the current registered MPLS Label values will be found in the IANA registries at [b-IANA Reg].

### **6.5.2 Label Manager**

Each label space within an MPLS-TP Network Element (NE) is controlled by a label manager. The label manager is a location independent logical function.

When an MPLS packet is received, its label is looked up in one particular label space as defined in clause 3.14 of [IETF RFC 3031].

The label manager is responsible for the allocation and reclamation of the labels that are used within MPLS. All MPLS applications (such as MPLS-TP) interface to this manager to obtain labels. The label manager coordinates the assignment of labels requested by the control plane and the management plane.

When a request is made to a label manager, a particular label value can be suggested. However there is no guarantee that the suggested label value would be allocated.

### **6.5.3 Labels for p2mp LSPs**

[IETF RFC 5332] defines the meaning of a "multicast label" and the semantics to be associated to a set of "next hop label forwarding entry" (NHLFE) to which that multicast label is mapped. The architecture defined in this Recommendation is aligned with [IETF RFC 5332].

## **7 Server/client associations**

Three forms of adaptation function are considered in this Recommendation:

- MT/client adaptation, where the client is not MPLS-TP.
- MT/MT adaptation, for supporting hierarchical MPLS-TP LSPs.
- Server/MT adaptation, where the server is not MPLS-TP.

### **7.1 MT/client adaptation**

The MT/client adaptation (MT/Client\_A) is considered to consist of two types of processes: client-specific processes and server-specific processes. The description of client-specific processes is outside the scope of this Recommendation.

#### **7.1.1 MT/ETH adaptation**

The encapsulation of Ethernet within MPLS-TP is defined in [IETF RFC 4448] and [IETF RFC 4720] and it is modelled in this clause. The raw mode is the default mode of encapsulation. The use of the Control Word (CW) is as defined [IETF RFC 5586]. The use of the FCS retention is optional as defined in [IETF RFC 4720]. The model for the Native Service Processing (NSP) and the forwarder described in [b-IETF RFC 3985] is outside the scope of this Recommendation.

The bidirectional MT/ETH adaptation (MT/ETH\_A) function is performed by a collocated pair of associated unidirectional MT/ETH adaptation source (MT/ETH\_A\_So) and sink (MT/ETH\_A\_Sk)



functions. The description of the client-specific processes is outside the scope of this Recommendation.

The MT/ETH adaptation source (MT/ETH\_A\_So) performs the following server-specific processes between its input and output:

- Insert the Control Word (CW) as defined in [IETF RFC 4448]. The CW is also known as the common interworking indicators (CII) in [ITU-T Y.1415].
- Map the ETH\_CI\_P and ETH\_CI\_DE signals (as defined in [ITU-T G.8110]) into the MT\_AI\_PHB signal.
- Insert a one-bit S field (of the PW LSE) set to "1".
- Select the output MT\_AP.
- Output the resulting MT\_AI.

The MT/ETH adaptation sink (MT/ETH\_A\_Sk) performs the following server-specific processes between its input and output:

- Multiplex the MT\_AI traffic units coming from all the MT\_APs.
- Extract and process the one-bit S field.
- Map the MT\_AI\_PHB signal into the ETH\_CI\_P and ETH\_CI\_DE signals.
- Extract the Control Word (CW), and optionally process the sequence number field as defined in [IETF RFC 4448] and [ITU-T Y.1415].

## 7.2 MT/MT adaptation

The bidirectional MT/MT adaptation (MT/MT\_A) function is performed by a collocated pair of associated unidirectional MT/MT adaptation source (MT/MT\_A\_So) and sink (MT/MT\_A\_Sk) functions.

Two associated unidirectional MPLS-TP (T)CPs that belongs to the same bidirectional LSP can have different labels associated with them.

The MT/MT adaptation source (MT/MT\_A\_So) performs the following processes between its input and its output.

- Forwarding or blocking client signal depending on the administrative state;
- Generation of OAM maintenance signals for Lock indication;
- Generate OAM signal to indicate the CI\_APS information (for the case when the MT/MT is used within an Subnetwork Connection Protection (SNCP) with Sublayer monitoring (SNC/S) protection switching scheme);
- Insert MCC and SCC packets from the MCN and SCN;
- Insert the same value 20-bit MPLS Label into each MT\_CI traffic unit associated with a particular connection point;
- Insert TC field according to processes described in clause 10;
- Multiplex the MPLS-TP Labelled frames;
- Insert a 1-bit S field set to 0.
- Select the output MT\_AP.

The MT/MT adaptation sink (MT/MT\_A\_Sk) performs the following processes between its input and output.

- Multiplex the MT\_AI traffic units coming from all the MT\_APs.

- Extract and process the 1-bit S field;
- Demultiplex the MPLS labelled Packets using the 20-bit label value;
- Remove the 20-bit Label;
- Derives the CI\_APS information from the OAM packets carrying it (for the case when the MT/MT is used within an SNC/S protection switching scheme);
- Extract MCC and SCC packets and deliver them to the MCN and SCN;
- Process TC field according to clause 10;
- Process TTL according to clause 11. When the TTL is decremented and has expired, the traffic unit is processed locally and may be discarded;
- generation of OAM maintenance signals for alarm suppression;
- forwarding or blocking client signal depending on the administrative state;
- generation of OAM maintenance signals for Lock indication.

### **7.3 Server/MT adaptation**

MPLS-TP can be carried over different server layers as described in section 5 of [IETF RFC 5960].

The server/MT adaptation function described in this clause excludes the case where the server is MPLS.

This function is considered to consist of two types of processes: client-specific processes and server-specific processes. The client-specific processes are associated with the MT\_CI traffic units, which ingress/egress via the MPLS-TP (T)CP. Server-specific processes are outside the scope of this Recommendation.

The bidirectional Srv/MT adaptation function is performed by a collocated pair of source and sink Srv/MT adaptation functions.

The Server/MT adaptation functions can work in two modes:

- mode 1: one or more MT connection points are allowed,
- mode 2 only a single MT connection point is allowed.

NOTE – The support of mode 1 is mandatory. Mode 2 supports MPLS-TP section monitoring and therefore it is optional.

Two associated unidirectional MPLS-TP (T)CPs that belongs to the same bidirectional LSP can have different labels associated with them.

For the case of mode 1, the Srv/MT adaptation source (Srv/MT\_A\_So) performs the following processes between its input and output.

- Forwarding or blocking client signal depending on the administrative state;
- Generation of OAM maintenance signals for Lock indication;
- Insert the same value 20-bit MPLS Label into each MT\_CI traffic unit associated with a particular connection point;
- Insert TC field according to processes described in clause 10;
- Multiplex the MPLS-TP Labelled frames.
- Server layer related specific processes

For the case of mode 1, the Srv/MT adaptation sink (Srv/MT\_A\_Sk) performs the following processes between its input and output:

- Server layer related specific processes
- Demultiplex the MPLS labelled Packets using the 20-bit label value;
- Remove the 20-bit Label;
- Process TC field according to clause 10;
- Process TTL according to clause 11. When the TTL is decremented and has expired, the traffic unit is processed locally and may be discarded.
- generation of OAM maintenance signals for alarm suppression
- forwarding or blocking client signal depending on the administrative state;
- generation of OAM maintenance signals for Lock indication.

For the case of mode 2, the Srv/MT adaptation source (Srv/MT\_A\_So) performs the following processes between its input and output.

- Forwarding or blocking client signal depending on the administrative state;
- Generation of OAM maintenance signals for Lock indication;
- Remove the TTL and S fields.<sup>4</sup>
- Server layer related specific processes

For the case of mode 2, the Srv/MT adaptation sink (Srv/MT\_A\_Sk) performs the following processes between its input and output:

- Server layer related specific processes
- Insert a TTL field equal to 254 and the S bit equal to 0. <sup>5</sup>
- generation of OAM maintenance signals for alarm suppression
- forwarding or blocking client signal depending on the administrative state;
- generation of OAM maintenance signals for Lock indication.

Further definition of the processes to adapt MPLS-TP to server layers is outside the scope of this Recommendation and will be described in [b-ITU-T G.8121].

If the server layer is Ethernet, a mechanism should be provided to enable the correct setting of the MAC destination address.

## 8 MPLS-TP OAM Architecture

This clause describes the OAM functionality needed for MPLS-TP network architecture in single or multi-domain scenarios.

The MPLS-TP OAM Requirements are defined in [IETF RFC 5860].

---

<sup>4</sup> Note that the description for the mode 2 includes the removal and replacement of the TTL and S fields. This is an artifact of the model and has no implication from an implementation point of view.

<sup>5</sup> Note that the description for the mode 2 includes the removal and replacement of the TTL and S fields. This is an artifact of the model and has no implication from an implementation point of view.

The MPLS-TP OAM Architecture and Framework are defined in [IETF [tp-oam-fw](#)].

The MPLS-TP OAM mechanisms and implementation are outside the scope of this Recommendation.

## **8.1 General**

### **8.1.1 Management and Control communications**

The MPLS-TP layer network supports Embedded Communication Channels (ECCs) between NEs to support management and control communications (MCC and SCC) as described in [ITU-T G.7712] and [IETF RFC 5718].

These forms of communication may also be supported externally to the MPLS-TP layer network.

Within the MPLS-TP layer network the Embedded Communication Channels (ECC) is provided using the Generic Associated Channel defined in [IETF RFC 5586], as described in [IETF RFC 5718].

### **8.1.2 Server/client interaction**

To avoid unnecessary, inefficient or conflicting survivability actions, escalation strategies are required as described in Requirement 61 of [IETF RFC 5654].

To avoid alarm storms in case of server layer failures, alarm suppression capabilities are required as described in section 2.2.8 of [IETF RFC 5860].

### **8.1.3 MPLS-TP maintenance entity groups**

MPLS-TP OAM operates in the context of Maintenance Entity Groups (MEGs) that are defined in [IETF [tp-oam-fw](#)]. The structure of the identifiers for the MEG, MEP and MIP are defined in [IETF [tp-ident](#)].

MPLS-TP OAM supports a single maintenance entity group (MEG) for network connection monitoring, an arbitrary number of maintenance entity groups (MEGs) for tandem connection monitoring and one maintenance entity group (MEG) for link connection monitoring.

NOTE – This Recommendation models SPME with 1:1 association (in order to implement tandem connection monitoring). SPMEs with 1:n association are not precluded but their model is for further study.

The maintenance entity for network connection monitoring monitors the MPLS-TP network connection between a pair of termination connection points at the boundary of the MPLS-TP layer network (see Figure 6-4).

The maintenance entity for tandem connection monitoring monitors the MPLS-TP tandem connection between any arbitrary pair of MPLS-TP connection points.

Multiple MEG levels are provided by means of label stacking as defined in [IETF [tp-oam-fw](#)].

MEGs can be used when the MPLS-TP layer network contains multiple administrative domains: e.g., service provider and one or more network operator domains. In this case, the interconnection between two administrative domains is always done via an MPLS-TP link connection.

Each of these administrative domains has an associated maintenance entity group located between a pair of MPLS-TP connection points at the boundaries of that MPLS-TP layer network administrative domain. Maintenance entity groups also exist between a pair of MPLS-TP connection points at the boundary of two adjacent MPLS-TP layer network administrative domains.

Figure 8-1 and Figure 8-2 illustrate such MPLS-TP layer network administrative domain maintenance entity groups for the point-to-point and point-to-multipoint connection cases.

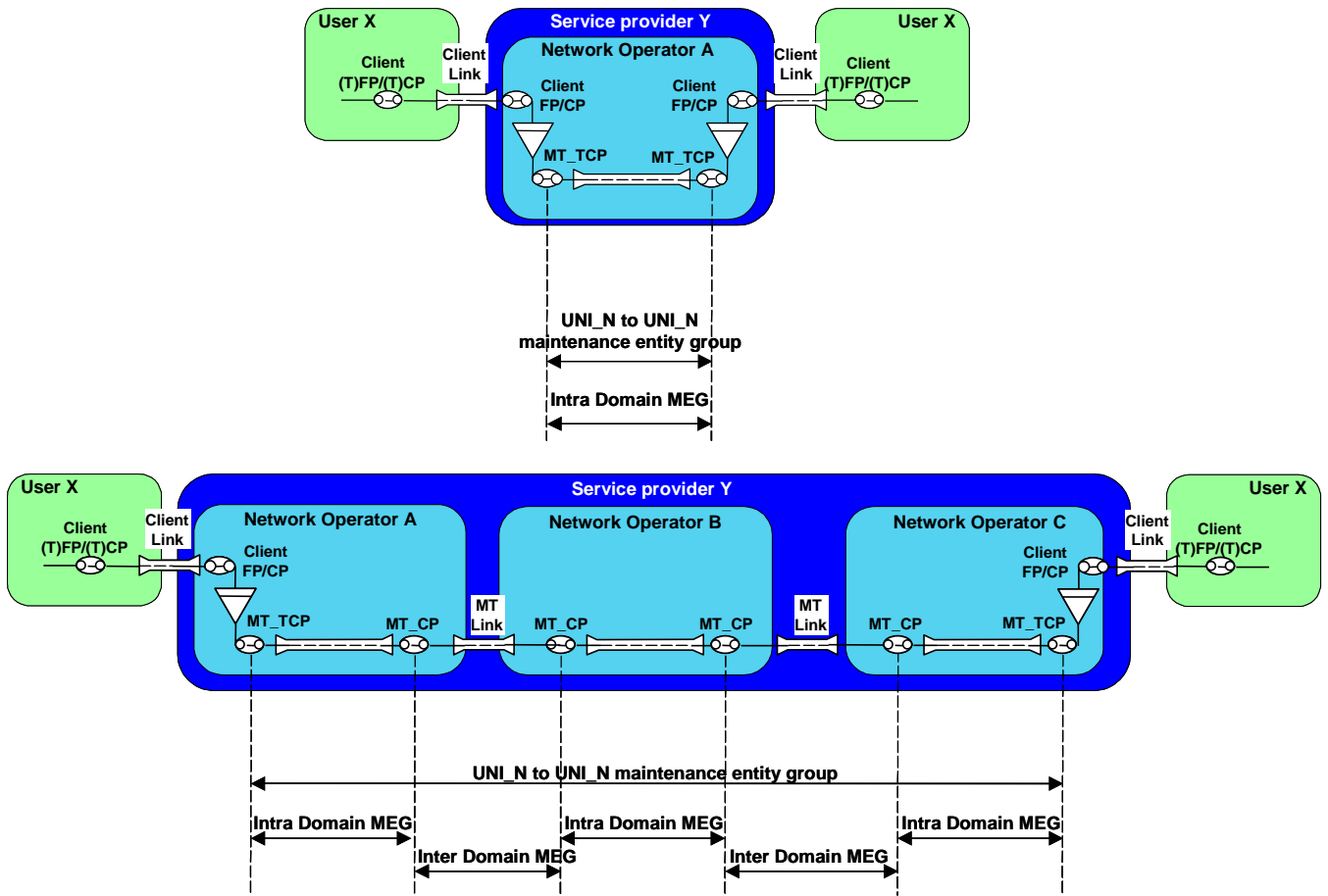
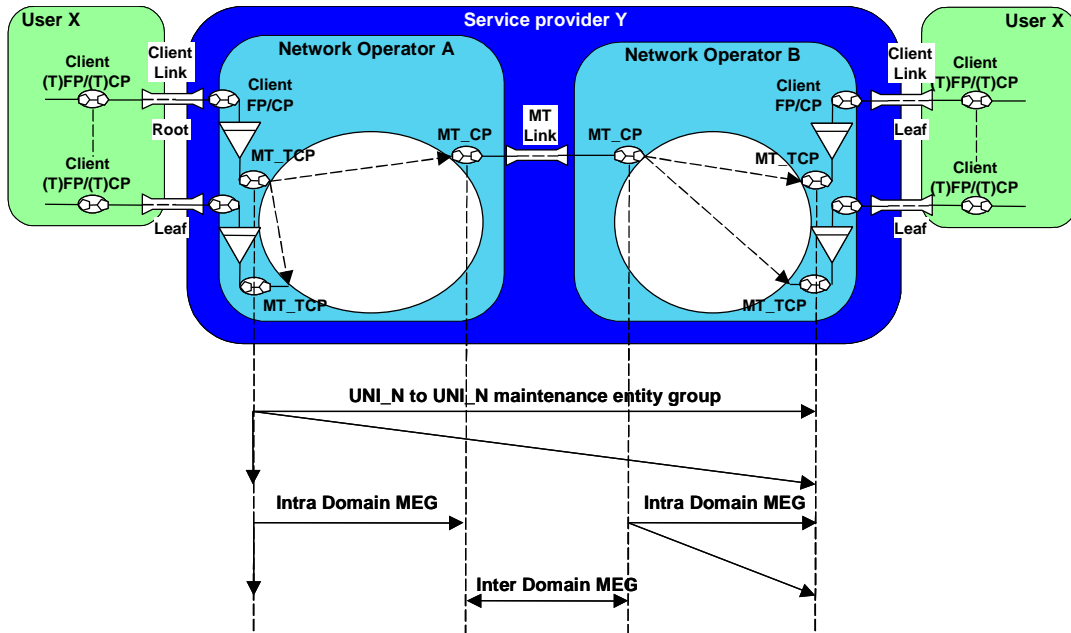

Figure 8-1 – Point-to-point MPLS-TP connection administrative domain associated maintenance entity groups



**Figure 8-2 – Point-to-multipoint MPLS-TP connection administrative domain associated maintenance entity groups**

MEGs can be used for operating protection switching or restoration applications as well as testing applications. Such maintenance entity groups can be between any two MPLS-TP connection points in the MPLS-TP layer network.

## 8.2 MPLS-TP connection and trail supervision

Connection supervision is the process of monitoring the integrity of a given maintenance entity group in the MPLS-TP layer network. The integrity may be verified by means of detecting and reporting continuity, connectivity and transmission performance defects for a given maintenance entity group. [ITU-T G.805] defines trail monitoring and four types of connection monitoring techniques for maintenance entity groups.

The maintenance entity group supervision process can be applied to network connections or tandem connections (an arbitrary series of subnetwork connections and link connections).

### 8.2.1 Inherent monitoring

MPLS-TP maintenance entity groups may be indirectly monitored by using the inherently available data from the server layers and computing the approximate state of the client connection from the available data.

MPLS-TP layer network maintenance entity groups may be indirectly monitored by using the inherently available data from the MPLS-TP server layers (e.g., SDH Virtual Container (VC), Optical Transport Hierarchy (OTH) Optical channel data unit (ODU), MPLS-TP server trail) and computing the approximate state of the MPLS-TP maintenance entity group from the available data.

### 8.2.2 Non-intrusive monitoring

This section is for further study.

### 8.2.3 Intrusive monitoring

For the diagnostic tests of certain parameters (e.g., throughput), an intrusive measurement has to be performed that interrupts the user data traffic in the diagnosed entity. The diagnostic tests can be performed as uni- or bidirectional diagnostic tests. In case of unidirectional tests, the user data

traffic in one direction is interrupted. In case of bidirectional tests, the user data traffic in both directions is interrupted. An OAM signal that carries the Lock indication is inserted for the immediate client ME at the egress of the interrupted entity.

This technique is restricted to the set-up, or intermittent testing.

#### **8.2.4 Trail monitoring**

The MT\_TT adds OAM to the adapted information such that the network connection's maintenance entity group can be directly monitored by the MPLS-TP trail created in the MPLS-TP layer network. With this technique, all parameters can be tested directly.

MPLS-TP layer network maintenance entity groups may be directly monitored by means of insertion of connection monitoring OAM at the ingress of the MPLS-TP trail and extraction and processing of this OAM at the egress of the MPLS-TP trail.

MPLS-TP LSP network connections are monitored by inserting OAM packets using the Generic Associated Channel (G-ACh) Label (GAL) and the ACh as defined in [IETF RFC 5586].

MPLS-TP PW network connections are monitored by inserting OAM packets using the ACh as defined in [IETF RFC 5586] and [IETF RFC 4385].

Insertion, extraction and processing of this connection monitoring OAM is functionally performed in MPLS-TP trail termination functions MT\_TT, which establish MPLS-TP connection-oriented trails.

NOTE – MPLS-TP OAM requirements are defined in [IETF RFC 5860]. MPLS-TP OAM mechanisms are outside the scope of this Recommendation.

##### **8.2.4.1 MPLS Interoperability considerations**

Within an MPLS-TP network, the PWE3 control word [IETF RFC 4385] is used to realize the associated control channel to carry PW OAM. This mechanism can be also used in existing MPLS deployments.

However, existing deployments may not support the CW or the ACh. Therefore other methods of PW OAM (e.g., VCCV types 2 and 3) that do not use the control word are used.

A detailed description of the interoperability is for further study.

#### **8.2.5 Sublayer monitoring**

Additional OAM and trail overhead is added to the original characteristic information such that the maintenance entity group of interest can be directly monitored by a trail created in a sub-layer. With this technique, all parameters can be tested directly. This scheme can provide for nested sub-layer trail monitored maintenance entity groups.

Tandem connection monitoring (TCM) for a segment of a given LSP is implemented by creating an SPME which spans the corresponding segment of the network and supports only the original LSP over this network segment as a client. This new SPME thus exists at the server sub-layer with respect to the original LSP

As described in [IETF [tp-oam-fw](#)], the DiffServ uniform model for TC processing (see section 10.1.2) is used to preserve the QoS information of the end-to-end MPLS-TP connection. Note that the short-pipe model for TTL handling is used to support the delivery of OAM packets to MIPs, based on TTL expiration, as defined in [IETF [tp-oam-fw](#)].

NOTE – Using different models for DiffServ and TTL processing on an SPME, for other than TCM purposes, as defined in [IETF [tp-oam-fw](#)] is not precluded.

The server sub-layer LSP is monitoring using normal LSP monitoring as defined above in clause 8.2.4. The server sub-layer LSP is viewed as a single hop by the client LSP.

Figure 8-3 below describes an example of TCM setup between nodes B and D to monitor a segment of an end-to-end LSP from node A to node D.

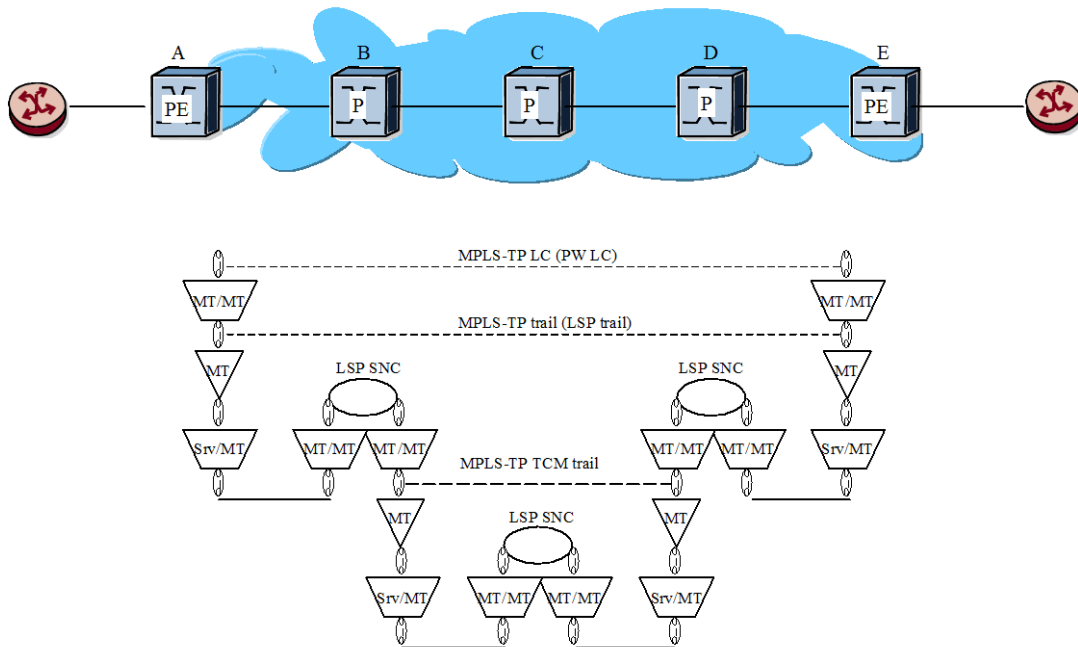

**Figure 8-3 – MPLS-TP TCM Example**

MPLS-TP LSP tandem connections are monitored by inserting G-ACh packets using the GAL and the ACH as defined in [IETF RFC 5586] within the sub-layer.

MPLS-TP PW tandem connection monitoring is outside the scope of this version of the Recommendation.

### 8.3 MPLS-TP Maintenance Entity Group monitoring

#### 8.3.1 Pro-active monitoring

MPLS-TP maintenance entity groups may be pro-actively monitored by means of continuous insertion of MPLS-TP OAM at the ingress of the MPLS-TP maintenance entity group and extraction and processing of this MPLS-TP OAM at the egress of the MPLS-TP maintenance entity group.

Insertion and extraction of pro-active OAM is performed by the MT\_TT atomic function (see section 6.2.3.1).

#### 8.3.2 On-demand monitoring

On-demand MPLS-TP MEG monitoring application complements the pro-active MPLS-TP monitoring application. On-demand MPLS-TP MEG monitoring application provides performance characterization and fault localization capabilities. The latter allow for discovering the node in which a MPLS-TP continuity or connectivity fault is located.

On-demand MPLS-TP OAM can be inserted at the ingress of the MPLS-TP maintenance entity, which is then replied to from intermediate and/or egress points of the MPLS-TP maintenance entity



group.

Insertion of on-demand OAM is done by the MT\_TT atomic function. Extraction and reply to on-demand OAM is done by:

- the MT\_TT atomic function (see section 6.2.3.1) in egress points of the MPLS-TP maintenance entity
- the MIP functional component (see section 8.4) in the intermediate points of the MPLS-TP maintenance entity

### 8.4 MPLS-TP MIP

In order to model a per-interface MIP, as defined in [IETF [tp-oam-fw](#)], the MPLS-TP MIP functional component is defined to be able to respond to on-demand MPLS-TP OAM signals received from both directions (Figure 8-4).

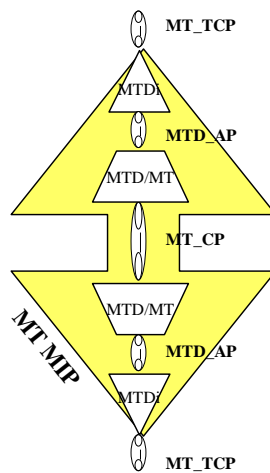

**Figure 8-4 – MPLS-TP MIP compound function**

In order to model a per-node MIP, as defined in [IETF [tp-oam-fw](#)], a variant of the MPLS-TP MIP functional component is the half MIP (MTDi) that is able to respond to on-demand MPLS-TP OAM signals received only from one direction (Figure 8-5).

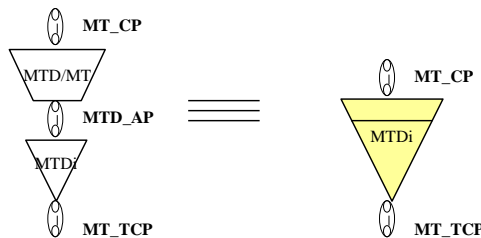

**Figure 8-5 – MPLS-TP half MIP compound function**

### 8.5 Bandwidth considerations with MPLS-TP OAM

The following considerations must be taken into account when planning the server layer capacity in networks where MPLS-TP OAM is activated:

- The GAL and ACH allow additional traffic, such as OAM or MCC/SCC, to be added to the existing client traffic. Bandwidth allocation must consider both on-demand and pro-active OAM traffic.

NOTE – When MCC/SCC is used; the required additional bandwidth is higher than the OAM.

- In setup of MPLS-TP LSP tandem connection (see 8.2.5), the label identifying tandem connection is attached for the all the MPLS-TP packets transiting the TCM, i.e. between B and D in Figure 8-3, this increases the bandwidth consumed by the traffic.

## 9 MPLS-TP survivability techniques

Requirements for MPLS-TP Survivability are defined in section 2.5 of [IETF RFC 5654].

MPLS-TP Survivability Architecture and Framework are defined-described in [b-IETF tp-surv-fw].

Restoration can be performed by a Network Management System (NMS) system or by a control plane as defined in [ITU-T G.8080] and described in [b-IETF tp-surv-fw].

## 10 MPLS-TP Diff-Serv Architecture

Both E-LSP and L-LSP, as defined in [IETF RFC 3270] and [IETF RFC 5462], are supported by MPLS-TP.

NOTE - The MPLS-TP architecture also supports the data plane for DiffServ-TE, as defined in [b-IETF RFC 4124]. The TC processing for Diff-Serv and DiffServ-TE is the same. The data planes of Diff-Serv and of the variants of DiffServ-TE differ in the implementation of the queuing process within the Server/MT\_A functions. These details are outside the scope of this Recommendation.

The setting of the traffic class (TC) field is as defined in [IETF RFC 3270] and [IETF RFC 5462] for the short-pipe and uniform models with no Penultimate Hop Popping (PHP).

The TC behaviour of these tunnelling models is provided in this clause by means of diagrams that describe the TC processing that occurs in each of the transport processing functions in the appropriate reference diagram.

In order to support short-pipe and uniform tunnelling modes, as defined in [IETF RFC 3270], the Server/MT\_A\_So function is configured, on individual MT\_CP basis, to encode the TC field based on one of the following QoS Encoding Modes:

- QoS Encoding Mode A where the TC field is encoded according to the outgoing PHB information;
- QoS Encoding Mode B where the TC field is encoded with any value (representing non-meaningful Diff-Serv information).

The Server/MT\_A\_Sk function is also configured, on individual MT\_CP basis, to decode the TC field based on one of the following QoS Decoding Modes:

- QoS Decoding Mode A where the outgoing PHB is determined by looking at the TC field;
- QoS Decoding Mode B where the outgoing PHB is received from the MT\_AP (because determined by looking at the TC field of a server level MPLS label stack entry).

Details on how the QoS Encoding Mode and QoS Decoding Mode are used to supported short-pipe and uniform MPLS-TP tunnelling modes are described in the following clauses 10.1.1 and 10.1.2.

The MT/Client\_A\_So function in Figure 10-1 selects the AI\_PHB in the MPLS-TP layer network using the Diff-Serv information in the client\_CI. The selection is client-specific.

### 10.1.1 Short-Pipe Model

The transport processing functions and processes for the short-pipe model (without penultimate hop popping) are described in Figure 10-1.

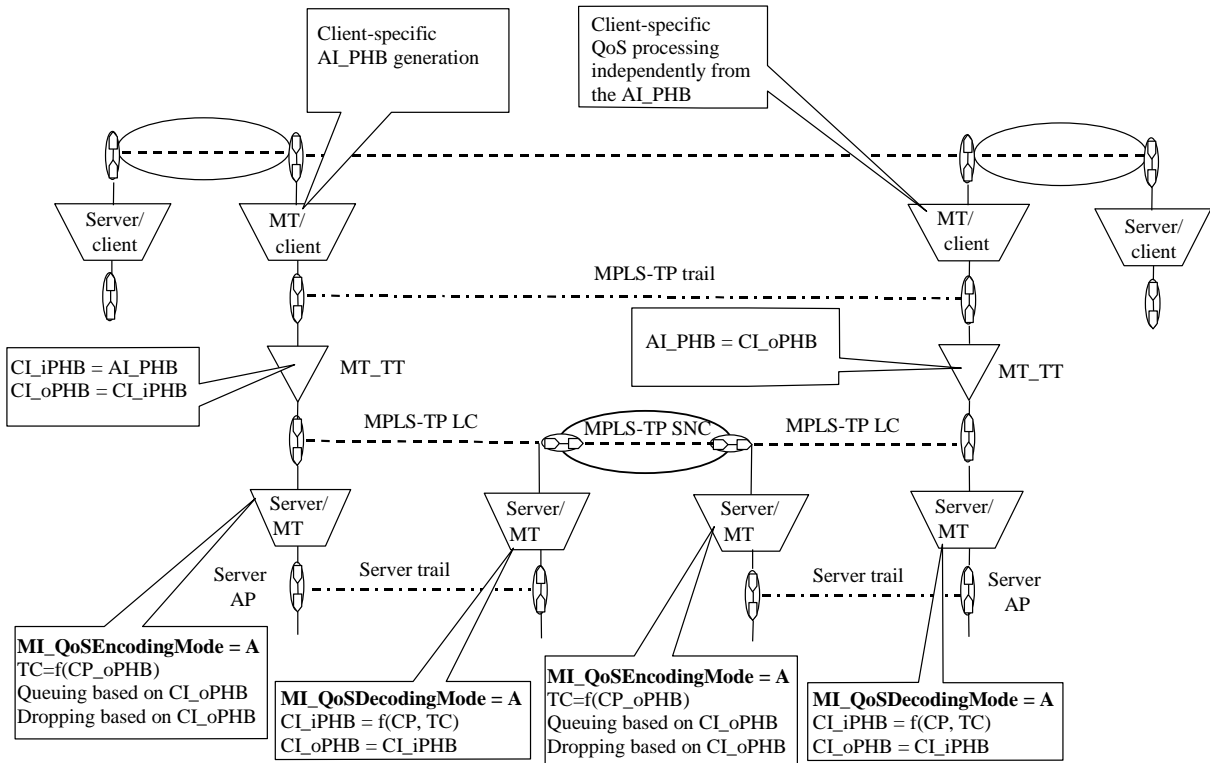
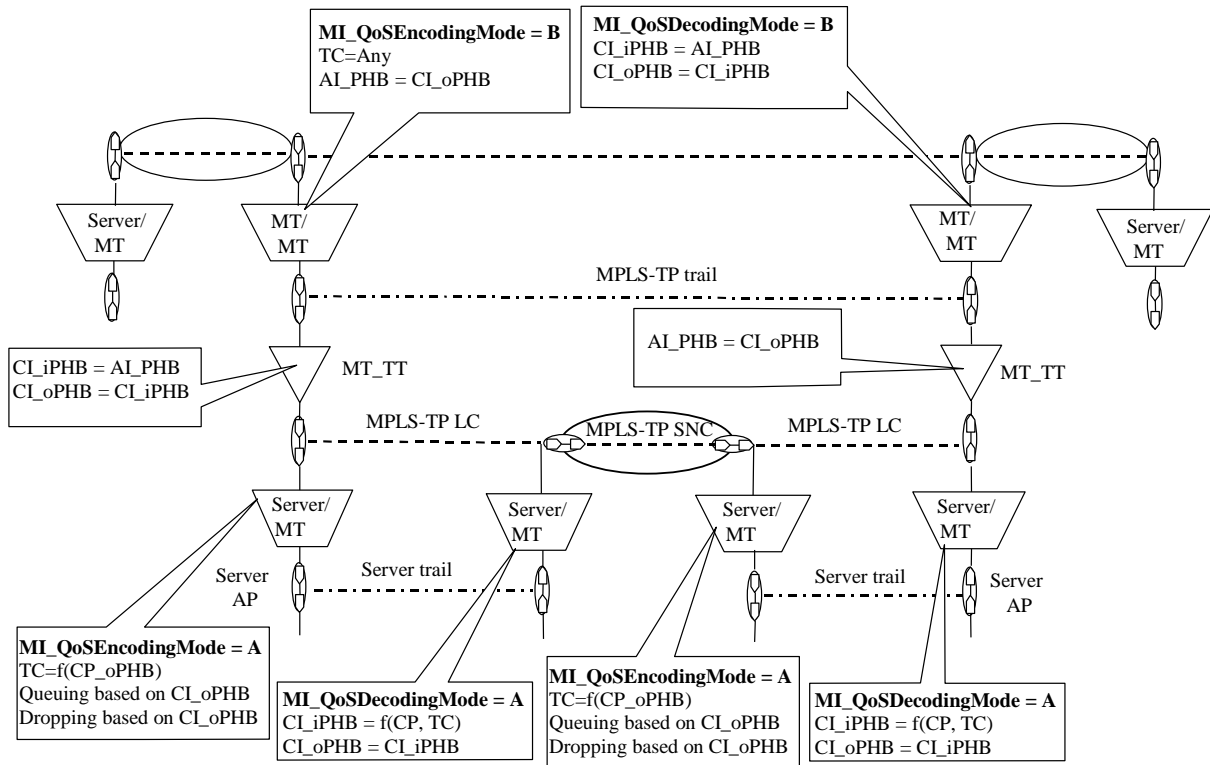

**Figure 10-1 – Reference diagram for the short-pipe model**

NOTE – The Server and Client layers in Figure 10-1 can be MPLS-TP or non MPLS-TP layers. The non MPLS-TP client layers are defined in clause 7.1; the non MPLS-TP server layers are defined in clause 7.3.

### 10.1.2 Uniform Model

The transport processing functions and processes for the uniform model (without penultimate hop popping) are described in Figure 10-2.



**Figure 10-2 – Reference diagram for the uniform model**

NOTE – The Server layers in Figure 10-2 can be MPLS-TP or non MPLS-TP layers. The non MPLS-TP server layers are defined in clause 7.3.

### 11 MPLS-TP TTL Behaviour

The setting of the time-to-live (TTL) field for data traffic is as defined in [IETF RFC 3443] for the short-pipe models with no PHP.

The setting of the time-to-live (TTL) field for the OAM traffic is as defined in [IETF RFC 5586] and [IETF tp-oam-fw].

Intermediate nodes decrement the TTL field as defined in [IETF RFC 3031] and [IETF RFC 3443].

If the TTL has expired, the packet is checked to see if it is an OAM packet. OAM packets are processed locally. All other packets with TTL expired are processed as defined in section 2.4 of [IETF RFC 3032].

### 12 Security aspects

The security considerations applicable to both MPLS and PWE3 apply to MPLS-TP as described in [IETF RFC 5921] and, [IETF tp-oam-fw] and [IETF tp-surv-fw].

Further security considerations are under development in IETF.

## Annex A

### Default configuration options for MPLS-TP in transport networks

(This annex forms an integral part of this Recommendation)

This annex provides options and configurations of MPLS-TP that allow consistent operations with other transport technologies defined by the ITU-T. MPLS-TP is a Connection-Oriented Packet Switched (CO-PS) technology and therefore can be modelled using [ITU-T G.805].

Equal Cost Multi-Path (ECMP) is not used with point-to-point and point-to-multipoint LSPs as described in [IETF RFC 5960].

A summary of the key default modes of operations described by this ITU-T Recommendation is:

- MPLS-TP connections are supported by traffic-engineered connections in the server layer to guarantee that the traffic loading imposed by other clients does not cause the transport service provided to the MPLS-TP layer to fall below the agreed level (see Requirement 32A [IETF RFC 5654]).
- Multi-link considerations described in [IETF **tp-oam-fw**] are not applicable.
- For MPLS-TP LSPs, PHP is disabled by default and this is the preferred mode of operation.
- Unidirectional or co-routed bidirectional point-to-point LSPs, as defined in [IETF RFC 5654] are supported. Co-routed bidirectional LSPs are defined by pairing the forward and backward directions to follow the same path (i.e., the same nodes and links). The pairing relationship between the forward and the backward directions is known in each node traversed by the bidirectional LSP.
- Unidirectional point-to-multipoint LSPs are supported, as defined in [IETF RFC 5654].
- The ITU-T format option for transport entities and OAM entities identifiers, as defined in [IETF **tp-ident**], is selected.
- Transport LSPs, as defined in [IETF RFC 5921], use the short-pipe model without PHP for TC processing, according to [IETF RFC 3270] and [IETF RFC 5462].
- In order to support tandem connection monitoring (as per section 8.2.5), SPMEs, as defined in in [IETF RFC 5921], use the uniform model without PHP for TC processing, according to [IETF RFC 3270] and [IETF RFC 5462].
- TC processing according to the short-pipe model without PHP according to [IETF RFC 3443].
- Both E-LSP and L-LSP are supported as defined in [IETF RFC 3270] and [IETF RFC 5462].
- In applications where the LSP has adequate bandwidth to carry its clients without dropping packets, only a single drop precedence is needed. In applications that use statistical multiplexing gain, more than one drop precedence may be used.
- Per-platform, per-interface and context-specific label spaces are supported as specified in [IETF RFC 5921] and [IETF RFC 5332].
- Multipoint-to-point and multipoint-to-multipoint LSPs are not supported.
- Non MPLS-TP Server layer networks are configured not to cause reordering of packets sent over an MPLS-TP connection (PW or LSP) in normal operations.
- The data plane (forwarding plane, OAM and resiliency) is operated and configured without any IP forwarding capability in the data plane as per requirement 36 of [IETF RFC 5654].

- The data plane (forwarding plane, OAM and resiliency) is logically and/or physically separated from the control and management plane as per requirements 15 and 16 of [IETF RFC 5654].

## **Appendix I**

### **An example of MPLS-TP layer structure**

(This appendix does not form an integral part of this Recommendation)

Unlike SDH and ATM technologies, which have a fixed number of layer network instances, MPLS-TP supports an arbitrary number of layer network instances. The number of layer network instances is in practice limited by physical limits (e.g. the MTU of the underlying physical links).

MPLS-TP technology can be used in a number of ways to implement packet transport networks.

This appendix provides an example of a layer structure in a MPLS-TP network that could be implemented using the MPLS-TP technology. Alternative layer structures are not precluded.

This MPLS-TP network example contains three MPLS-TP layer network instances. These MPLS-TP layer network instances are PW, LSP and Section.

The PW layer network instance provides the transport service layer as defined in [IETF RFC 5654]. The PW layer network instance provides OAM for inherent monitoring of the network connection that supports the client service. The structure of the client service is outside the scope of this Recommendation and it may comprise a single client signal or a bundle of such client signal.

The LSP layer network instance provides the transport path layer as defined in [IETF RFC 5654]; a LSP connection carries one or more PW signals between the edges of LSP domains.

An optional MPLS-TP Section (MTS) layer network instance provides the section layer as defined in [IETF RFC 5654]; a MTS connection carries one or more LSP signals between MPLS-TP network nodes. The MTS layer network instance provides OAM for connection monitoring of the point-to-point transmission media layer signal that interconnects MPLS-TP network nodes. This optional MTS layer network instance would typically be used in cases where the physical media layer does not support the required OAM functionality adequately, the MTS connection spans more than one physical link or the MTS connection is protected.

Note that because there is a one-to-one relationship between the MTS layer network instance and the server layer trail, no MTS label stack entry is added to the frames sent over the PHY media (reference point 9 in Figure I-1 below). This requires operating the Server/MT\_A function according to mode 2 (as described in section 7.3).

Note that in order to be able to apply the MTS layer network instance in practical networks, the server layer connection must have a point-to-point topology.

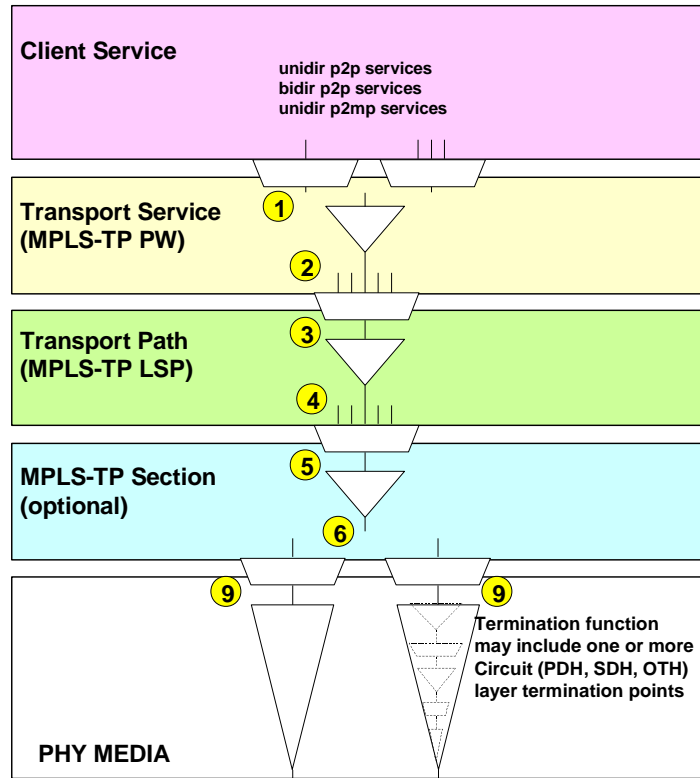

**Figure I-1 – MPLS-TP network architecture (layer view) example**

The MPLS-TP network supports MPLS-TP OAM in the MPLS-TP layer network instances. MPLS-TP OAM protocols are under definition by a set of IETF Internet-Drafts. [ITU-T **G.tpoam**] provides, via referencing these Internet-Drafts, an overview of the complete MPLS-TP OAM toolset.

It is possible to support carrier's applications at any of the MPLS-TP layer network instances. The MPLS-TP network of one operator (B) may carry any one of the MPLS-TP layer network instances of another operator (A) as a client layer service. Alternatively the MPLS-TP network of one operator (B) may emulate a physical interconnection between the MPLS-TP devices of another operator (A) and carry the full stack, including the PHY information as a client layer service.

NOTE – The emulation of a physical interconnection between MPLS-TP devices, via another operator's MPLS-TP network, cannot support all the properties of a real physical interconnection (e.g. synchronization).

MPLS-TP networks of two operators (C, D) may also peer at the PW layer network instance. This mode of operation (peering) would typically be preferred to a client-server relationship between the networks when the client layer service has endpoints on both MPLS-TP operator networks C and D.

MPLS-TP OAM mechanisms support MPLS-TP tandem connection monitoring (TCM). TCM will allow each owner (service provider, network operators C and D) to monitor its tandem connection.

MPLS-TP networks provide both unidirectional and bidirectional point-to-point and unidirectional point-to-multipoint MPLS-TP connections. Within the PW layer network instance, those connections support bidirectional point-to-point and unidirectional point-to-multipoint services.

The adapted information (AI), characteristic information (CI) and OAM information (OI) traffic unit formats in the different layer networks are illustrated in Figure I-2 to Figure I-7. The



information is numbered between 1 and 9, whose numbers relate to the location of this information in Figure I-1.

Note that the MTS\_AI in Figure I-5 contains the S bit for a MTS label stack entry and the MTS\_CI in Figure I-6 contains both the S bit and the TTL field for a MTS label stack entry. From a functional point of view, the Server/MT\_A\_So function, operating according to mode 2 as described in clause 7.3, removes the S bit and the TTL field from the MTS label stack entry before sending the frame to the PHY media. In the sink direction, the Server/MT\_A\_Sk function, operating according to mode 2 as described in clause 7.3, inserts, from a functional point of view, an S bit equal to 0 and a TTL field equal to 254.

Therefore no MTS label stack entry is present on the frames sent over the PHY media (Figure I-7).

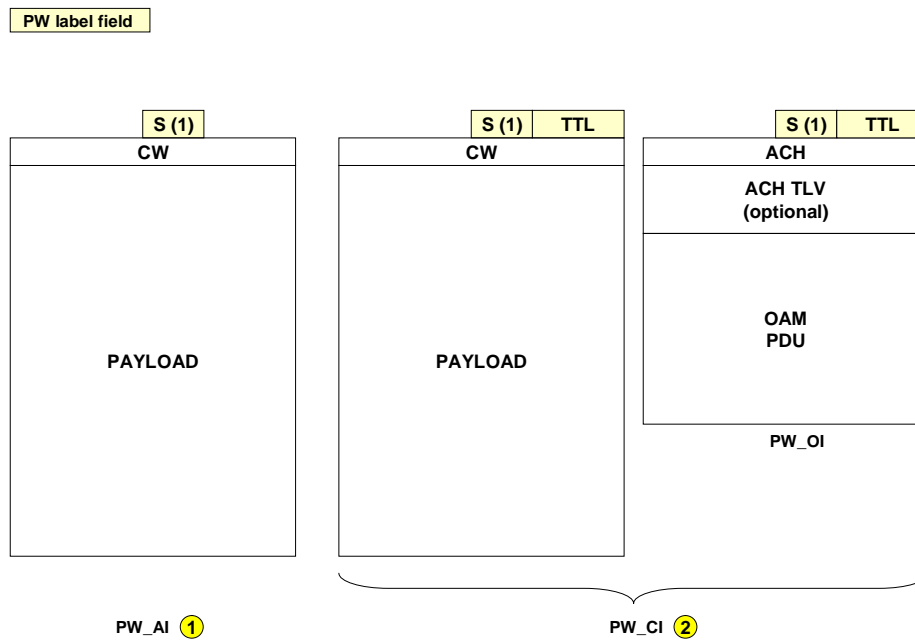

**Figure I-2 – MPLS-TP network adapted and characteristic information traffic units (Reference points 1 and 2)**

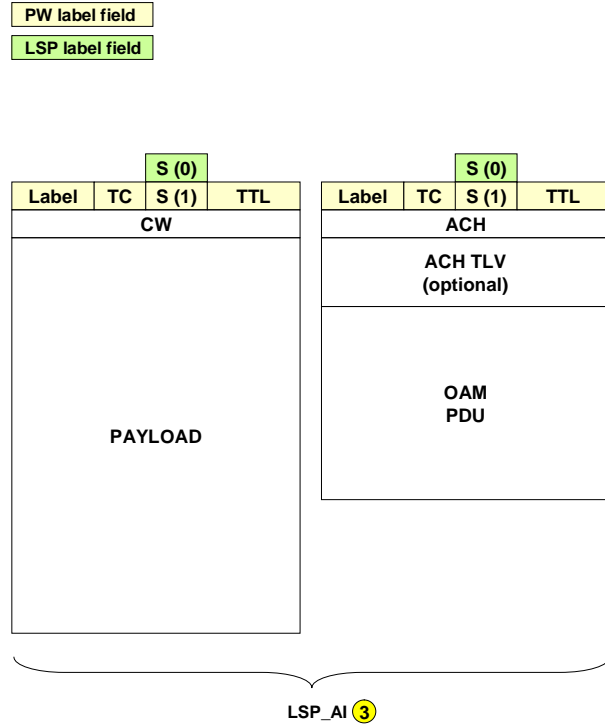

Figure I-3 – MPLS-TP network adapted and characteristic information traffic units (Reference point 3)

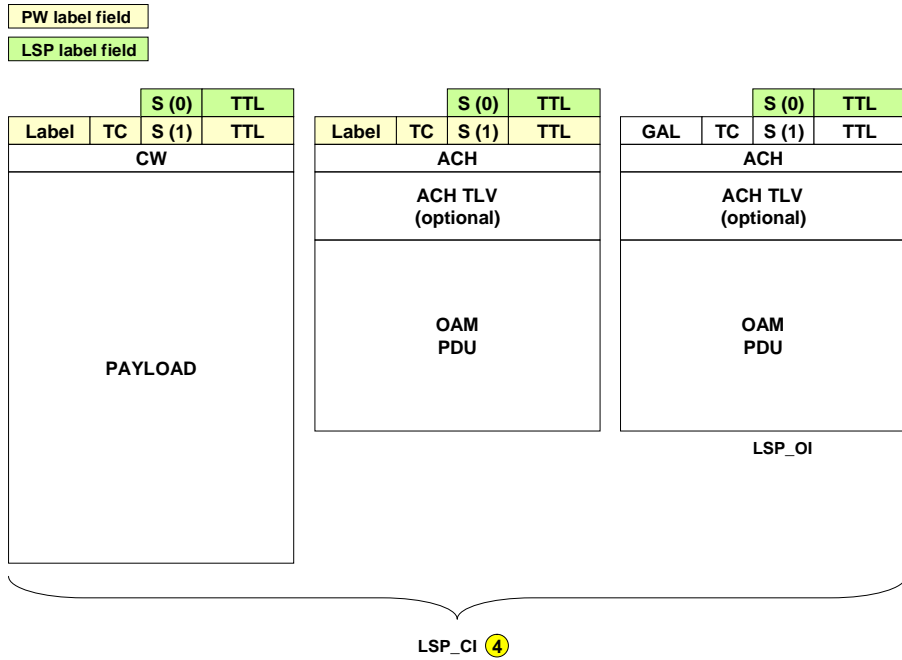
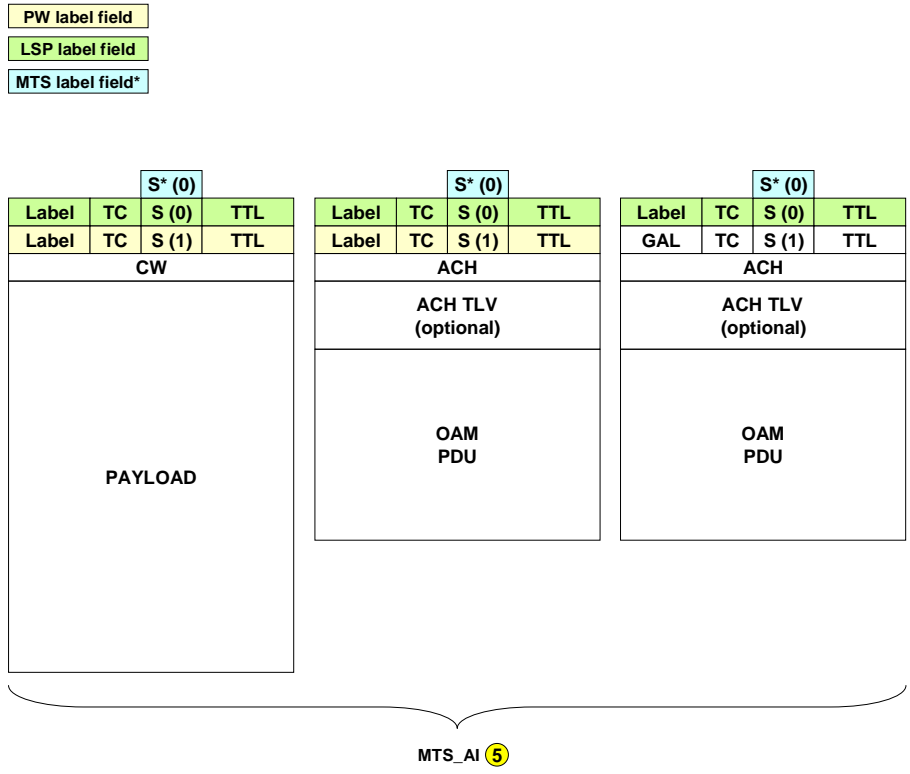

Figure I-4 – MPLS-TP network adapted and characteristic information traffic units (Reference point 4)



\*) The MTS label stack entry fields are removed by the physical media adaptation source function

**Figure I-5 – MPLS-TP network adapted and characteristic information traffic units (Reference point 5)**

- PW label field
- LSP label field
- MTS label field\*

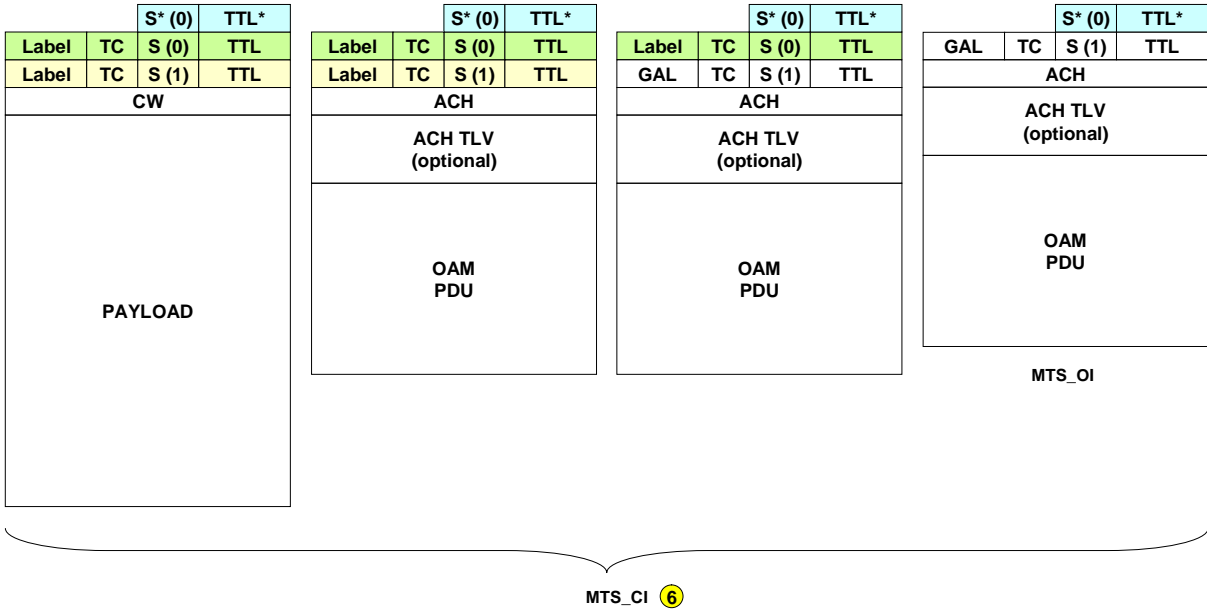

\*) The MTS label stack entry fields are removed by the physical media adaptation source function

**Figure I-6 – MPLS-TP network adapted and characteristic information traffic units (Reference point 6)**

PW label field  
 LSP label field

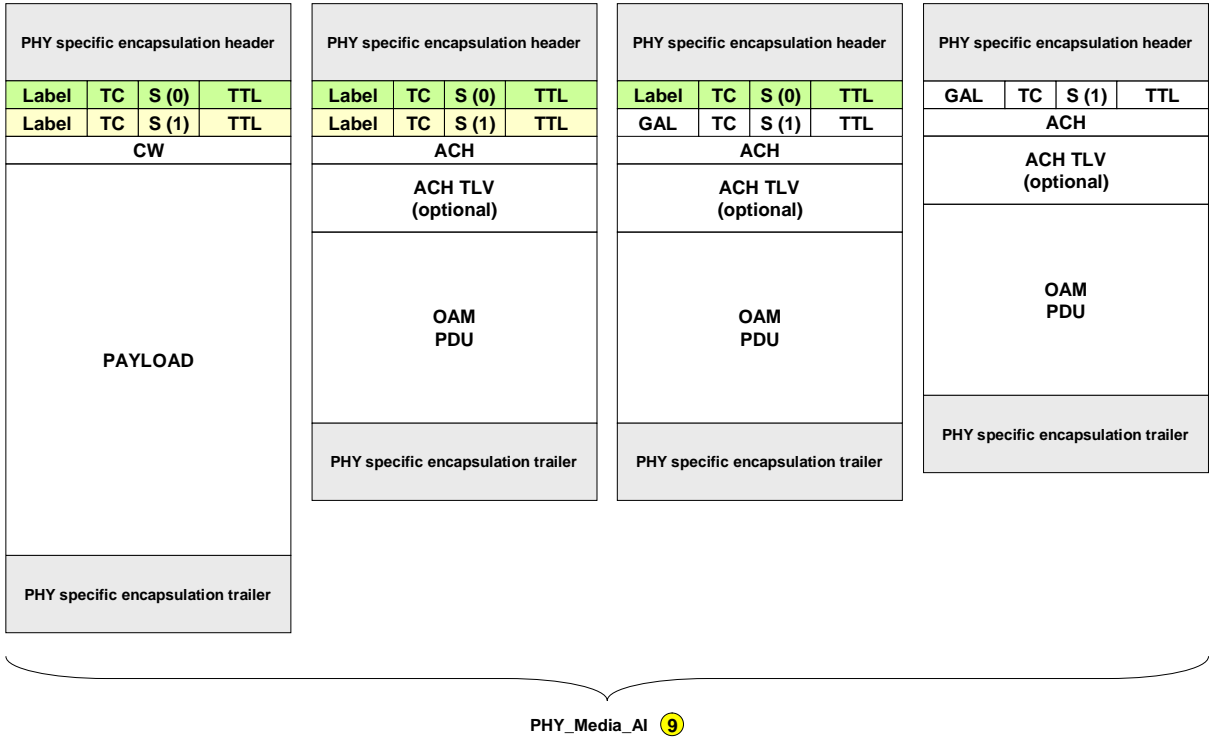

**Figure I-7 – MPLS-TP network adapted and characteristic information traffic units (Reference point 9)**

## Bibliography

- [b-ITU-T G.8121] ITU-T **Draft Revised** Recommendation G.8121/Y.1381 (2010), *Characteristics of MPLS-TP equipment functional blocks*.
- [b-ITU-T G.tpoam] ITU-T **Draft** Recommendation **G.tpoam** (2010), *Operations, Administration and Maintenance mechanism for MPLS-TP networks*.
- [b-IANA Reg] IANA, Registered Label Values for Multiprotocol Label Switching Architecture (MPLS).  
<<http://www.iana.org/assignments/mpls-label-values/mpls-label-values.xhtml>>
- [b-IETF RFC 3985] IETF RFC 3985 (2005), *Pseudo Wire Emulation Edge-to-Edge (PWE3) Architecture*.
- [b-IETF RFC 4124] IETF RFC 4124 (2005), *Protocol Extensions for Support of Diffserv-aware MPLS Traffic Engineering*.
- [b-IETF RFC 4461] IETF RFC 4461 (2006), *Signaling Requirements for Point-to-Multipoint Traffic-Engineered MPLS Label Switched Paths (LSPs)*.
- [b-IETF RFC 5950] IETF RFC 5950 (2010), *Network Management Framework for MPLS-based Transport Networks*.
- [b-IETF **tp-cp-fw**] IETF **Internet Draft draft-ietf-ccamp-mpls-tp-cp-framework-03.txt** (2010), *MPLS-TP Control Plane Framework*.
- [b-IETF **tp-surv-fw**] IETF **Internet Draft draft-ietf-mpls-tp-survive-fwk-06.txt** (2010), *Multiprotocol Label Switching Transport Profile Survivability Framework*.
-