

TELECOMMUNICATION
STANDARDIZATION SECTORTD 039 Rev.1 (PLEN/15)

STUDY PERIOD 2013-2016

English only

Original: English

Question(s): 10/15

1-12 July 2013

TD

Source: Editor G.8113.1/Y.1372.1

Title: Draft Amendment 1 to Recommendation ITU-T G.8113.1/Y.1372.1 (2012) (for Determination, July 2013)

This document contains the drafting result of G.8113.1 Amendment 1 ~~from the MPLS-TP experts meeting (Hiroshima, 8 Jan. – 1 Feb. 2013)~~, which is intended for determination.

Input documents:

<u>Document Number</u>	<u>Title</u>	<u>Results</u>
<u>TD39/Plen (SG15 Plen, July 2013)</u>	<u>Draft Amendment 1 to Recommendation ITU-T G.8113.1/Y.1372.1 (2012) (for Determination, July 2013)</u>	<u>Drafting result from MPLS-TP experts meeting (Hiroshima, 8 Jan ~ 1 Feb. 2013)</u>
<u>C 204 (SG15 Plen, July 2013)</u>	<u>Proposal to modify clause 7.1.2 for an Amendment to G.8113.1</u>	<u>Agreed for drafting</u>

Contact: Han Li
China Mobile Communications Corporation
P.R.China
Tel: +86-10-15801696688-33092
Fax: +86-10-63601087
Email: lihan@chinamobile.com

Contact: Jia He
Huawei Technologies Co., Ltd.
P.R.China
Tel: +86-755-28972597
Fax: +86-755-28979835
Email: hejia@huawei.com

Attention: This is not a publication made available to the public, but **an internal ITU-T Document** intended only for use by the Member States of ITU, by ITU-T Sector Members and Associates, and their respective staff and collaborators in their ITU related work. It shall not be made available to, and used by, any other persons or entities without the prior written consent of ITU-T.

Draft Amendment 1 to Recommendation ITU-T G.8113.1/Y.1372.1 (2012)

Operations, Administration and Maintenance mechanism for MPLS-TP in Packet Transport Network (PTN): Amendment 1

1) Clause 2, References

Update

[ITU-T Y.1731] ITU-T Recommendation Y.1731 (2008), *OAM functions and mechanisms for Ethernet based networks*, plus Amendment 1 (2010).

with

[ITU-T G.8013] ITU-T Recommendation G.8013/Y.1731 (2011), *OAM functions and mechanisms for Ethernet based networks*, plus Corrigendum 1 (2011) and Amendment 1 (2012).

(change this reference [ITU-T Y.1731] → [ITU-T G.8013] throughout the whole document)

Add the following reference

[ISO 3166-1] ISO 3166-1 alpha-2, “Codes for the representation of names of countries and their subdivisions -- Part 1: Country codes.”

[IETF RFC 6423] IETF RFC6423 (2011), *Using the Generic Associated Channel Label for Pseudowire in the MPLS Transport Profile (MPLS-TP).*

2) Add the specification of “Route Tracing” in Section 7

(1) Add the on demand “Route Tracing” OAM item in Table 7-1/G.8113.1: OAM Functions.

7.2 OAM functions specification

Table 7-1/G.8113.1: OAM Functions

Application	OAM Function	
Fault Management	Pro-active	Continuity Check and Connectivity Verification (CC/CV)
		Remote Defect Indication (RDI)
		Alarm Indication Signal (AIS)

	On-demand	Client Signal Fail (CSF) ¹
		Connectivity Verification (CV)
		<u>Route Tracing (RT)</u>
		Diagnostic test (DT)
		Locked Signal (LCK) ²
Performance Management	Pro-active	Loss measurement (LM)
		Delay measurement (DM)
	On-demand	Loss measurement (LM)
		Delay measurement (DM)
Other Applications	Automatic Protection Switching (APS)	
	Management communication channel/ Signaling communication channel (MCC/SCC)	
	Vendor-specific (VS)	
	Experimental (EXP)	

(2) Add a new clause to specify “Route Tracing” in Clause 7.2.1.2.

7.2.1.2 On-demand OAM Functions for Fault Management

7.2.1.2.3 Route Tracing

Route tracing (RT) enables a MEP to discover the ordered sequence of MIPs (if any) and MEP(s) within a MEG.

The Route Tracing (RT) OAM function can be implemented using the LBM OAM PDU with the “Discovery ingress/node MEP/MIP” and/or the “Discovery egress MEP/MIP” TLVs in the Target MEP/MIP ID TLV which are defined in Clause 8.2.2. However detailed procedures for implementing the RT OAM function are for further study in this version of the Recommendation.

3) Add the globally uniqueness consideration of IDs used in G.8113.1

8.2 OAM PDU Formats based on Y.1731

Insert a new paragraph after the first:

This recommendation describes the use of the CC and ICC based MIP and MEP identifiers. MPLS-TP supports also IP-based formats for MIP and MEP identifiers³. The possible mixing of CC and

¹ Client Signal Fail (CSF) is called Client Failure Indication (CFI) in [IETF RFC 5860]

² Locked Signal (LCK) is called Lock Reporting in [IETF RFC 5860]

ICC based formats and IP based formats within an operator domain is for further study.
The encoding of the IP-based formats is also for further study.

8.2.1. Continuity Check Message (CCM)

In order to perform pro-active Connectivity Verification, the CCM packet contains a globally unique identifier of the source MEP, which is the combination of a globally unique MEG ID with a MEP ID that is unique within the scope of the Maintenance Entity Group.

The generic format for MEG ID is defined in Figure A-1 of [ITU-T Y.1731]. Different formats of MEG ID are allowed: the MEG ID format type is identified by the MEG ID Format field.

The formats of both the ICC-based MEG ID, and the CC-, and ICC-, based global MEG ID are is defined in Annex A of [ITU-T Y.1731]. Both of these This-formats isare applicable to MPLS-TP Sections, LSPs and PWs. If a globally unique MEG ID is required the CC- and ICC-based MEG ID must be used.

~~MPLS-TP supports also IP based format for MEG ID. These formats are outside the scope of this version of the Recommendation.⁴~~

8.2.2.1 Target and Replying MEP/MIP ID TLVs

The format of the Target and Replying ~~MIP/MEP/MIP~~ ID TLVs are shown in Figure 8-6 and Figure 8-7.

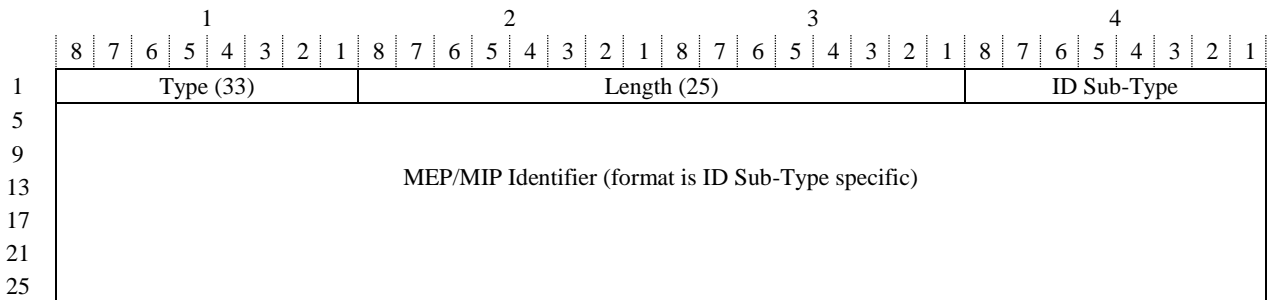

Figure 8-6/G.8113.1 – Target MEP/MIP ID TLV format

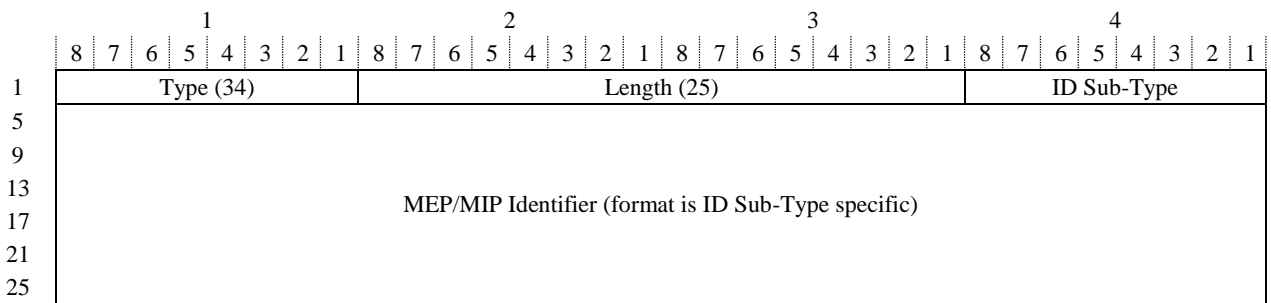

Figure 8-7/G.8113.1 – Replying MEP/MIP ID TLV format

³ The semantics for IP-based identifiers for MIP and MEP are defined in IETF RFC6370: see [b-IETF 6370]

⁴ ~~The IP based format for MEG ID is under definition in IETF: see [b-IETF tp id]~~

Different formats of MEP/MIP identifiers can be defined: the format type is described by the MEP/MIP ID Sub-Type field (see Table 8-4).

Table 8-4 /G.8113.1– MEP/MIP Identifier Sub-Type values

ID Sub-Type	MEP/MIP Identifier Name	MEP/MIP Identifier Length
0x00	Discovery ingress/node MEP/MIP	0
0x01	Discovery egress MEP/MIP	0
0x02	ICC-based MEP ID	2 bytes
0x03	ICC-based MIP ID	16 bytes
0x04-0xFF	Reserved	

The “Discovery ingress/node MEP/MIP” and the “Discovery egress MEP/MIP” identifiers can only be used within the LBM PDU (and cannot appear in an LBR PDU) for discovering the identifiers of the MEPs or of the MIPs located at a given TTL distance from the MEP originating the LBM PDU.

The format of the Target MEP/MIP ID TLV carrying a “Discovery ingress/node MEP/MIP” is shown in Figure 8-8.

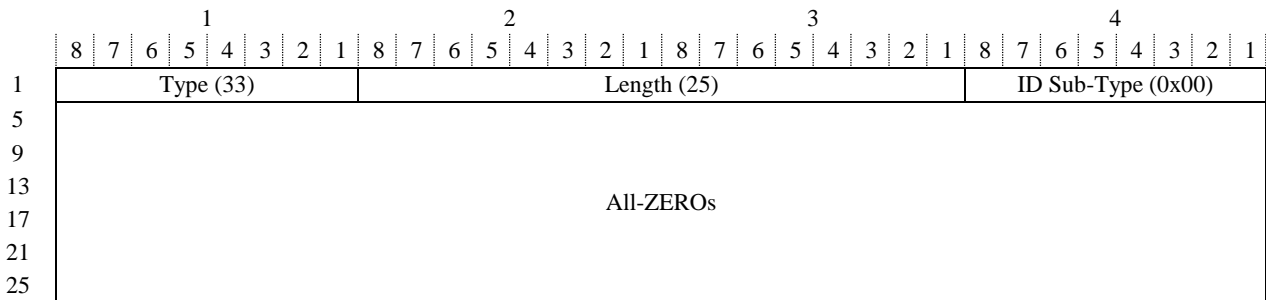

Figure 8-8/G.8113.1 – Target MEP/MIP ID TLV format for Discovery ingress/node MEP/MIP

The format of the Target MEP/MIP ID TLV carrying a “Discovery egress MEP/MIP” is shown in Figure 8-9.

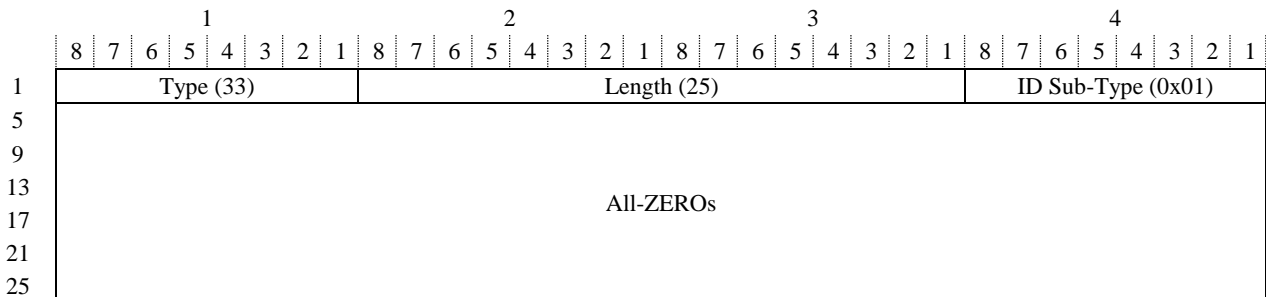

Figure 8-9 /G.8113.1– Target MEP/MIP ID TLV format for Discovery egress MEP/MIP

The format of the Target or Replying MEP/MIP ID TLV carrying an “~~ICC-based~~ MEP ID” is shown in Figure 8-10.

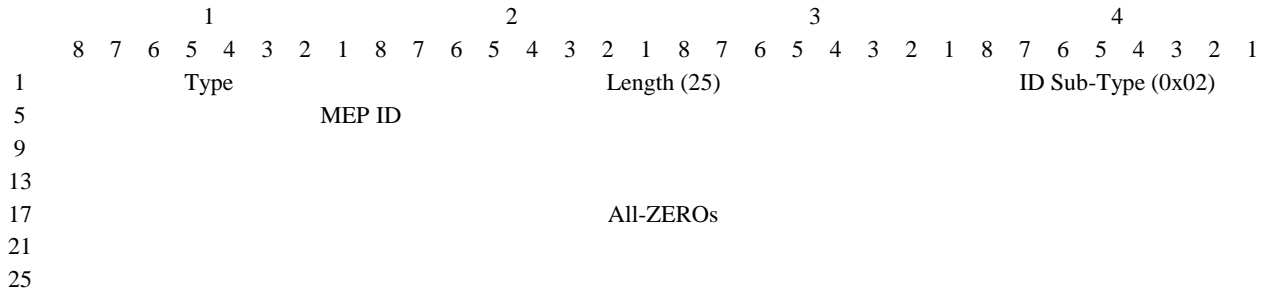

Figure 8-10/G.8113.1 – Target or Replying MEP/MIP ID TLV format for (ICC-based-MEP ID)

The MEP ID is a 16-bit integer value identifying the transmitting MEP within the MEG.

The format of the Target or Replying MEP/MIP ID TLV carrying an “ICC-based-MIP ID” is shown in Figure 8-11.

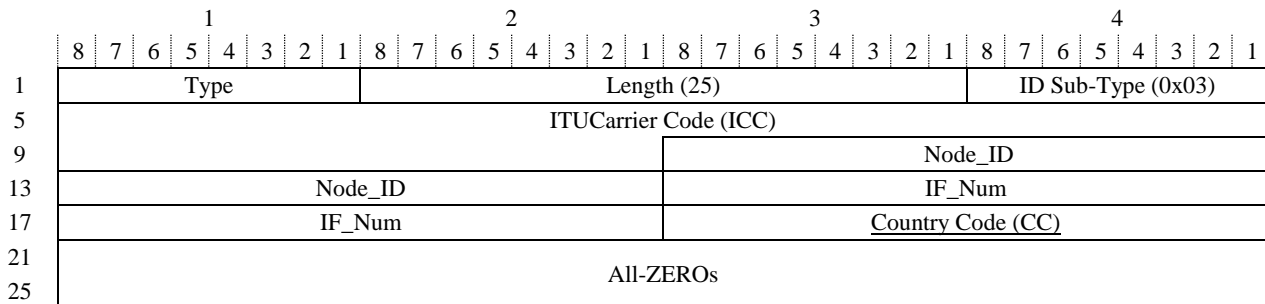

Figure 8-11/G.8113.1 – Target or Replying MEP/MIP ID TLV format for (ICC-based-MIP ID)

The ITU-T Carrier Code (ICC) is a code assigned to a network operator/service provider and maintained by the ITU-T Telecommunication Standardization Bureau (TSBs) as per [ITU-T M.1400]. The ITU Carrier Code field in Figure 8-11 consists of between 1 and 6 left-justified characters with trailing NULLs completing the ICC field.

For backward compatibility, in the case global uniqueness is not required, the CC field may be All ZERO's.

The Node_ID is a numeric identifier of the node where the MIP is located. Its assignment is a matter for the organization to which the ICC has been assigned, provided that uniqueness within that organization is guaranteed.

The IF_Num is a numeric identifier of the Access Point (AP) toward the server layer trail, which can be either an MPLS-TP or a non MPLS-TP server layer, where a per-interface MIP is located. Its assignment is a matter for the node the MIP is located, provided that uniqueness within that node is guaranteed. Note that the value 0 for IF_Num is reserved to identify per-node MIPs.

The Country Code (alpha-2) is a string of 2 alphabetic characters represented with upper case letter (i.e., A-Z). The Country Code format is defined in [ISO3166-1].

8.2.2.2 Requesting MEP ID TLV

Replace

The MEP ID and MEG ID carry the globally unique MEP ID as defined in clause 8.2.1.

with

~~The MEP ID and MEG ID carry the globally unique MEP ID as defined in clause 8.2.1.~~

The globally unique identifier for a MEP can be provided by combination of a globally unique MEG ID with a MEP ID as defined in clause 8.2.1.

4) Bibliography

Update

[b-IETF tp-id] IETF draft-ietf-mpls-tp-identifiers-04, *MPLS-TP Identifiers*.

with

[b-IETF RFC 6370] IETF RFC 6370 (2011), *MPLS-TP Identifiers*.

Update all the corresponding footnotes.

5) Add a new Clause 10 to describe security considerations.

10. Security

According to clause 6.3 of this Recommendation packets originating outside the MEG are encapsulated by the MEP at the ingress and transported transparently through the MEG. This encapsulation significantly reduces the risk of an attack from outside the MEG. The MEP at the egress also prevents OAM packets from leaving a MEG.

The use of the CV tool improves network integrity by ensuring traffic is not misconnected or mismerged between LSPs. The expected MEP_ID is provisioned at the sink MEP, this allows the received MEP_ID to be verified with a high degree of certainty, which significantly reduces the possibility of an attack.

The use of globally unique identifiers for MEP-IDs by combination of a globally unique MEG ID with a MEP ID provides an absolute authoritative detection of persistent misconnection between LSPs. A globally unique MEG ID should be used when an LSP between the networks of different national operators crosses national boundaries since Non-uniqueness can result in undetected misconnection in a scenario where two LSPs use a common MEGP-ID.

For the use of any other OAM tools it is assumed that MEPs and MIPs that start using the tools verify the integrity of the path and the identity of the source MEP. If a misconnection is detected the tool in use shall be disabled immediately.

6) Usage of GAL for PW - Modify the text in clause 7.1.2

7.1.2 GAL

A G-ACh Alert Label (GAL) is used to flag the G-ACh. Specifically, the GAL is used to indicate that a packet contains an ACH followed by a non-service payload (i.e., the G-ACh packet payload), thus generalizing the associated control channel mechanism to LSPs, Sections, PWs and tandem connections.

The GAL provides an alert based exception mechanism to:

- Differentiate G-ACh packets (e.g., OAM, DCC, APS, etc.) from those of user traffic packets
- Indicate that the ACH appears immediately after the bottom of the label stack.

One of the reserved label values defined in [IETF RFC 3032] is assigned for this purpose: the reserved label value assigned is 13. ~~The GAL must always be at the bottom of the label stack (i.e., S bit set to 1).~~ The format of the GAL is specified in Sub-clause 8.1 in alignment with [IETF RFC 5586].

NOTE – Using GAL for PW in MPLS-TP is specified in [IETF RFC 6423]. In MPLS-TP, the GAL MUST be used with packets on a G-Ach on LSPs, Sections, and tandem connections, and MAY be used with PWs

7) Update of Abbreviations and acronyms

Delete the single-character abbreviation of “A”, “C”, “N”, “O”, “P”, “S” in Clause 4.
Delete the abbreviation of “IO”, “IP”.

~~A Adaptation function~~

~~C Customer~~

~~IO Intermediate Operator~~

~~IP Intermediate Provider~~

~~N Network~~

~~O Operator~~

~~P Provider~~

~~S Stack~~

Add the description of “C”, “IO”, “IP”, “O”, “P” in Figure I.1 of Appendix I.

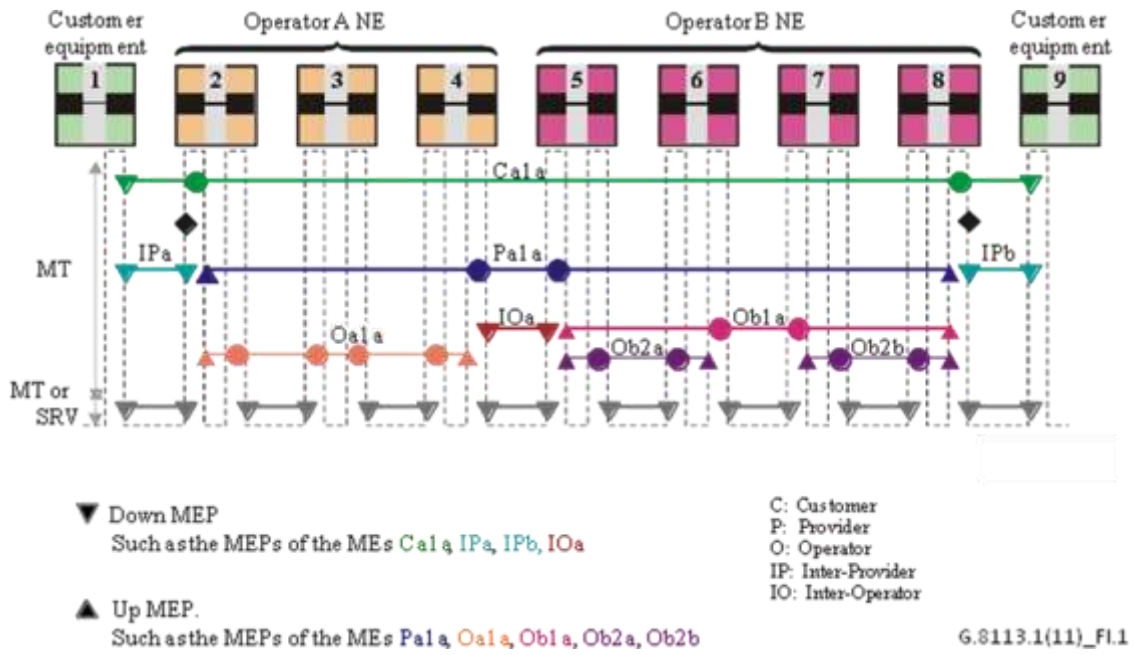

Figure I.1 – Example MEG nesting