



Question(s): 14/15

Geneva, 20 November-01 December 2023

TD

Source: G.8350 Editors

Title: Draft Amendment 1 to Recommendation ITU-T G.8350 “Management and control for metro transport networks” (for consent)

Contact: Rod LU
China Mobile Communications Corporation
China
Tel: +86 15801696688 - 34572
E-mail: lurongduo@chinamobile.com

Contact: Liping Chen
CICT
China
Tel: +86 15902785581
E-mail: chenlp@cict.com

Contact: Scott Mansfield
Ericsson
Canada
Tel: +1 724-931-9316
E-mail: scott.mansfield@ericsson.com

Abstract: The document contains the draft amendment 1 to Recommendation G.8350 “Management and control for metro transport network” for consent.

Document history:

Version	Date	Description
1.0.1	TD177/WP3 (04-2023)	<p>Initial version created by taking prepublished G.8350 (11/2022) as the base.</p> <p>Document updates:</p> <ul style="list-style-type: none">• Apply the proposals in C528 to update clause 13.1 and clause 13.2.1.• Apply the proposals in cd14c-12 (Dec.2022) to add clause 13.2.4. <p>Papyrus UML updates:</p> <ul style="list-style-type: none">• Based on C528 and C529:<ul style="list-style-type: none">▪ Create an MTNS TTP Group Overview to add MtnsTtpGroup and its Pac object classes.▪ Update MTN High-level Overview.▪ Update the attached UML Model file in clause 14. <p>To do:</p> <ul style="list-style-type: none">• Add the attributes for MTNP TT based on cd14c-11(Dec.2022) and C529 (April 2023);• Update the UML model based on the proposed DD in C532.

Version	Date	Description
	cd14c-08 (05-2023)	<p>Papyrus UML updates:</p> <ul style="list-style-type: none"> Update the attributes of MtnpTtpSinkPac based on cd14c-11 and C532. <p>Editor's note: The delay measurement fragments are to be done based on C532, but it was found that the DD in C532 is not consistent with one approved in 2022.09, the changing marks only show the changes on the attributes but actually all the delay related objects are new and needs to be captured into the on-going new version.</p>
	cd14c-08r1 (06-2023)	<p>Papyrus UML updates:</p> <ul style="list-style-type: none"> Add the DM related object classes and data types on C532. Update the attached UML Model file in clause 14.
	cd14c-08r2 (08-2023)	<p>Papyrus UML updates:</p> <ul style="list-style-type: none"> Add associations between the DM data types based on the discussion of cd14c-08r1. Update the attached UML Model file in clause 14.

Version	Date	Description
1.0.2	cd14c-08r3 (10-2023)	<p>Document updates:</p> <ul style="list-style-type: none"> Apply the proposals in wd1214-67 (09-2023) to update clause 10.1.8. <p>Papyrus UML updates:</p> <ul style="list-style-type: none"> Based on the proposed updates of DD in wd1214-44R1(09-2023): Add new attributes for the following object classes: <ul style="list-style-type: none"> MtnpCtpSinkPac: currentProblems; MtnpSn: uuid, name; MtnsTtpGroupPac: groupNumber; MtnsTtpGroupSinkPac: timDectectionMode, timActionDisabled, acceptedCc, acceptedCca, acceptedCcb, currentProblems; MtnsCtpSinkPac: currentProblems; MtnsTtpPac: tTi; MtnsTtpSinkPac: currentProblems, acTi, acceptedGid, acceptedlid, acceptedFlexeMap; Add the new DataType: FlexeCcConfiguration, FlexeCcInUse, MtnpCtpProblem, MtnsTtpProblem, MtnsTtpGroupProblem, MtnsCtpProblem; Add the descriptions for object classes and attributes; Update the typos for the names of the MTNS Group related Pac objects and some other attribute; Remove the redundant association attributes for MtnpCtp and MtnpSn; Change OtsiaTtp to PmsTtp and also update the note for OtsiaTtp accordingly based on the discussion of wd1214-44. Shorten the association names per the general agreement achieved during the interim meeting. Update the attached UML model file in clause 14 including the DD for the updated UML model. <p>To be further confirmed for the UML model:</p> <ul style="list-style-type: none"> Whether the empty Pac objects need to be deleted? If the <<Preliminary>> stereotype could be deleted?
	cd14c-08r4 (10-2023) TD196/PLEN (11-2023)	<p>Document updates:</p> <ul style="list-style-type: none"> Taking the in-force version as the base to include all agreed changes since v1.0.1. <p>Papyrus UML updates:</p> <ul style="list-style-type: none"> Based on the agreement in the e-meeting on 11 Oct. 2023: <ul style="list-style-type: none"> Remove the empty Pac objects. Remove the <<Preliminary>> stereotype for all the object classes, and set the attributes needing more discussion to be preliminary. The updated UML model file is attached in clause 14.

Version	Date	Description
1.1	TD196R1/PLEN (12-2023)	<p>Document updates:</p> <ul style="list-style-type: none"> • Update the clause 10.1.8 for delay measurement requirements per the agreements of C805. • Remove cLOBA related contents in clause 7 and also the abbreviation in clause 2, and remove the clause 8.14 power monitoring and control per C866. • Update the figures in clause 13 based on the latest UML model and also add descriptions for MTNS TTP Group, DM and PM current/history data related object classes during drafting. <p>Papyrus UML updates:</p> <ul style="list-style-type: none"> • Update the UML version to be v1.1. • Based on the agreements of C805, C807: <ul style="list-style-type: none"> – Update the DM fragment model. – Add the PM fragment model. • Doing some cleaning up. <p>The updated UML model file is attached in clause 14.</p>

Recommendation

ITU-T G.8350 (11/2022) Amd. 1 (xx/202x)

SERIES G: Transmission systems and media, digital systems and networks

Packet over Transport aspects – Mobile network transport aspects

Management and control of metro transport networks

Amendment 1



ITU-T G-SERIES RECOMMENDATIONS
TRANSMISSION SYSTEMS AND MEDIA, DIGITAL SYSTEMS AND NETWORKS

INTERNATIONAL TELEPHONE CONNECTIONS AND CIRCUITS	G.100–G.199
GENERAL CHARACTERISTICS COMMON TO ALL ANALOGUE CARRIER-TRANSMISSION SYSTEMS	G.200–G.299
INDIVIDUAL CHARACTERISTICS OF INTERNATIONAL CARRIER TELEPHONE SYSTEMS ON METALLIC LINES	G.300–G.399
GENERAL CHARACTERISTICS OF INTERNATIONAL CARRIER TELEPHONE SYSTEMS ON RADIO-RELAY OR SATELLITE LINKS AND INTERCONNECTION WITH METALLIC LINES	G.400–G.449
COORDINATION OF RADIOTELEPHONY AND LINE TELEPHONY	G.450–G.499
TRANSMISSION MEDIA AND OPTICAL SYSTEMS CHARACTERISTICS	G.600–G.699
DIGITAL TERMINAL EQUIPMENTS	G.700–G.799
DIGITAL NETWORKS	G.800–G.899
DIGITAL SECTIONS AND DIGITAL LINE SYSTEM	G.900–G.999
MULTIMEDIA QUALITY OF SERVICE AND PERFORMANCE – GENERIC AND USER-RELATED ASPECTS	G.1000–G.1999
TRANSMISSION MEDIA CHARACTERISTICS	G.6000–G.6999
DATA OVER TRANSPORT – GENERIC ASPECTS	G.7000–G.7999
PACKET OVER TRANSPORT ASPECTS	G.8000–G.8999
Ethernet over Transport aspects	G.8000–G.8099
MPLS over Transport aspects	G.8100–G.8199
Synchronization, quality and availability targets	G.8200–G.8299
Mobile network transport aspects	G.8300–G.8399
Service Management	G.8600–G.8699
ACCESS NETWORKS	G.9000–G.9999

For further details, please refer to the list of ITU-T Recommendations.

Recommendation ITU-T G.8350

Management and control of metro transport networks

Amendment 1

Summary

Recommendation ITU-T G.8350 specifies management and control requirements and a protocol-neutral management information model for managing metro transport networks and their elements.

History

Edition	Recommendation	Approval	Study Group	Unique ID*
1.0	ITU-T G.8350	2022-11-13	15	11.1002/1000/15121
<u>1.1</u>	<u>ITU-T G.8350</u>	<u>2023-xx-xx</u>	<u>15</u>	

Keywords

Control, information model, management, metro transport network (MTN), protocol-neutral, unified modelling language (UML).

* To access the Recommendation, type the URL <http://handle.itu.int/> in the address field of your web browser, followed by the Recommendation's unique ID. For example, <http://handle.itu.int/11.1002/1000/11830-en>.

FOREWORD

The International Telecommunication Union (ITU) is the United Nations specialized agency in the field of telecommunications, information and communication technologies (ICTs). The ITU Telecommunication Standardization Sector (ITU-T) is a permanent organ of ITU. ITU-T is responsible for studying technical, operating and tariff questions and issuing Recommendations on them with a view to standardizing telecommunications on a worldwide basis.

The World Telecommunication Standardization Assembly (WTSA), which meets every four years, establishes the topics for study by the ITU-T study groups which, in turn, produce Recommendations on these topics.

The approval of ITU-T Recommendations is covered by the procedure laid down in WTSA Resolution 1.

In some areas of information technology which fall within ITU-T's purview, the necessary standards are prepared on a collaborative basis with ISO and IEC.

NOTE

In this Recommendation, the expression "Administration" is used for conciseness to indicate both a telecommunication administration and a recognized operating agency.

Compliance with this Recommendation is voluntary. However, the Recommendation may contain certain mandatory provisions (to ensure, e.g., interoperability or applicability) and compliance with the Recommendation is achieved when all of these mandatory provisions are met. The words "shall" or some other obligatory language such as "must" and the negative equivalents are used to express requirements. The use of such words does not suggest that compliance with the Recommendation is required of any party.

INTELLECTUAL PROPERTY RIGHTS

ITU draws attention to the possibility that the practice or implementation of this Recommendation may involve the use of a claimed Intellectual Property Right. ITU takes no position concerning the evidence, validity or applicability of claimed Intellectual Property Rights, whether asserted by ITU members or others outside of the Recommendation development process.

As of the date of approval of this Recommendation, ITU had not received notice of intellectual property, protected by patents/software copyrights, which may be required to implement this Recommendation. However, implementers are cautioned that this may not represent the latest information and are therefore strongly urged to consult the appropriate ITU-T databases available via the ITU-T website at <http://www.itu.int/ITU-T/ipr/>.

© ITU 2023

All rights reserved. No part of this publication may be reproduced, by any means whatsoever, without the prior written permission of ITU.

Table of Contents

	Page
1 Scope.....	1
2 References.....	1
3 Definitions	2
3.1 Terms defined elsewhere.....	2
3.2 Terms defined in this Recommendation.....	3
4 Abbreviations, acronyms and symbols.....	3
4.1 Abbreviations and acronyms.....	3
4.2 Symbols.....	6
5 Conventions.....	7
5.1 Information modelling conventions.....	7
6 MTN management and control architecture.....	8
6.1 Relationship between the management and control system, MTN.MN and MTN.MSN.....	8
6.2 Metro transport network section layer connectivity verification function and interface distinguishing function.....	8
6.3 MTN.NE automatic online management.....	8
7 Fault management.....	9
7.1 Fault management applications.....	9
7.2 Fault management functions.....	10
8 Configuration management.....	14
8.1 Hardware.....	14
8.2 Software.....	14
8.3 Protection switching.....	14
8.4 Trail termination.....	14
8.5 Adaptation.....	15
8.6 Connection.....	17
8.7 Degraded thresholds.....	18
8.8 ZZZ_Reported.....	18
8.9 Alarm severity.....	18
8.10 Alarm reporting control.....	18
8.11 Performance management thresholds.....	18
8.12 Tandem connection monitoring activations.....	18
8.13 Date and time.....	18
8.14 Power monitoring and control.....	19
8.15 Fault event filtering.....	19
9 Accounting management.....	19
10 Performance management.....	19
10.1 Performance management applications.....	19

	Page
10.2 Performance management functions	22
11 Security management.....	22
12 Network-level management and control requirements for MTN	23
12.1 Topology management	23
12.2 Connectivity control	23
12.3 Virtual network management	23
12.4 Path computation	24
12.5 Notification management	24
12.6 Performance management	24
13 Information model for metro transport networks	24
13.1 Overview of the model	24
13.2 Model fragments.....	26
14 UML model file	33
Annex A – LLDP organizationally specific TLVs in MTN	35
A.1 MTNS connectivity verification.....	35
A.2 MTNS/FlexE interface distinction	36
A.3 LLDP organizationally specific TLVs transmission channel.....	38
Annex B – MTN.NE automatic online management.....	39
Bibliography.....	41

Recommendation ITU-T G.8350

Management and control of metro transport networks

Amendment 1

Editorial note: This is a complete-text publication. Modifications introduced by this amendment are shown in revision marks relative to Recommendation ITU-T G.8350 (2022).

1 Scope

This Recommendation describes the management and control of metro transport network (MTN) technology. It specifies the management and control requirements, and an information model for managing transport functions in MTN equipment, its system, as well as the MTN path (MTNP) and section layers. The management specification is based on the MTN architecture, interface, equipment and protection functional specification Recommendations. The management requirements utilize existing generic management requirements in [ITU-T G.7710], [ITU-T G.7702], [ITU-T G.7718] and the information model is based on the core information model of [ITU-T G.7711].

[This amendment enhances the information model for MTN and aligns with \[ITU-T G.8321\].](#)

2 References

The following ITU-T Recommendations and other references contain provisions which, through reference in this text, constitute provisions of this Recommendation. At the time of publication, the editions indicated were valid. All Recommendations and other references are subject to revision; users of this Recommendation are therefore encouraged to investigate the possibility of applying the most recent edition of the Recommendations and other references listed below. A list of the currently valid ITU-T Recommendations is regularly published. The reference to a document within this Recommendation does not give it, as a stand-alone document, the status of a Recommendation.

- [ITU-T G.800] Recommendation ITU-T G.800 (2016), *Unified functional architecture of transport networks*.
- [ITU-T G.805] Recommendation ITU-T G.805 (2000), *Generic functional architecture of transport networks*.
- [ITU-T G.806] Recommendation ITU-T G.806 (2012), *Characteristics of transport equipment – Description methodology and generic functionality*.
- [ITU-T G.826] Recommendation ITU-T G.826 (2002), *End-to-end error performance parameters and objectives for international, constant bit-rate digital paths and connections*.
- [ITU-T G.7701] Recommendation ITU-T G.7701 (2022), *Common control aspects*.
- [ITU-T G.7702] Recommendation ITU-T G.7702 (2022), *Architecture for SDN control of transport networks*.
- [ITU-T G.7703] Recommendation ITU-T G.7703/Y.1304 (2022), *Architecture for the automatically switched optical network*.
- [ITU-T G.7710] Recommendation ITU-T G.7710/Y.1701 (2020), *Common equipment management function requirements*.
- [ITU-T G.7711] Recommendation ITU-T G.7711/Y.1702 (2022), *Generic protocol-neutral information model for transport resources*.

- [ITU-T G.7712] Recommendation ITU-T G.7712/Y.1703 (2019), *Architecture and specification of data communication*.
- [ITU-T G.7718] Recommendation ITU-T G.7718/Y.1709 (2020), *Framework for the management of management-control components and functions*.
- [ITU-T G.8013] Recommendation ITU-T G.8013/Y.1731 (2015/2023), *Operations, administration and maintenance (OAM) functions and mechanisms for Ethernet-based networks*.
- [ITU-T G.8310] Recommendation ITU-T G.8310 (2020), *Architecture of the metro transport network*.
- [ITU-T G.8312] Recommendation ITU-T G.8312 (2020), *Interfaces for metro transport networks*.
- [ITU-T G.8321] Recommendation ITU-T G.8321 (2022), *Characteristics of metro transport network equipment functional blocks*.
- [ITU-T G.8331] Recommendation ITU-T G.8331 (2022), *Metro transport network linear protection*.
- [ITU-T M.20] Recommendation ITU-T M.20 (1992), *Maintenance philosophy for telecommunication networks*.
- [ITU-T M.2120] Recommendation ITU-T M.2120 (2002), *International multi-operator paths, sections and transmission systems fault detection and localization procedures*.
- [ITU-T M.3010] Recommendation ITU-T M.3010 (2000), *Principles for a telecommunications management network*.
- [ITU-T M.3100] Recommendation ITU-T M.3100 (2005), *Generic network information model*.
- [ITU-T X.700] Recommendation ITU-T X.700 (1992), *Management framework for open systems interconnection (OSI) for CCITT applications*.
- [IEEE 802.1AB] IEEE 802.1AB-2016, *IEEE Standard for Local and metropolitan area networks – Station and media access control connectivity discovery*.
- [IEEE 802.3] IEEE 802.3-2022, *IEEE Standard for Ethernet*.

3 Definitions

3.1 Terms defined elsewhere

This Recommendation uses the following terms defined elsewhere:

- 3.1.1 adaptation** [ITU-T G.805]
- 3.1.2 atomic function** [ITU-T G.806]
- 3.1.3 adapted information** [ITU-T G.805]
- 3.1.4 alarm reporting control** [ITU-T M.3100]
- 3.1.5 connection** [ITU-T G.805]
- 3.1.6 connection controller** [ITU-T G.7701]
- 3.1.7 discovery agent** [ITU-T G.7701]
- 3.1.8 dual-ended** [ITU-T G.8013]

- 3.1.9 **Flex Ethernet implementation agreement; FlexE** [ITU-T G.8312]
- 3.1.10 **layer network** [ITU-T G.805]
- 3.1.11 **link** [ITU-T G.805]
- 3.1.12 **link resource manager** [ITU-T G.7701]
- 3.1.13 **MAC frame** [IEEE 802.3]
- 3.1.14 **MC component** [ITU-T G.7701]
- 3.1.15 **management point (MP)** [ITU-T G.806]
- 3.1.16 **managed object** [ITU-T X.700]
- 3.1.17 **network element** [ITU-T M.3010]
- 3.1.18 **network element function** [ITU-T M.3010]
- 3.1.19 **operations system** [ITU-T M.3010]
- 3.1.20 **path** [ITU-T G.806]
- 3.1.21 **routing controller** [ITU-T G.7701]
- 3.1.22 **section** [ITU-T G.806]
- 3.1.23 **single-ended** [ITU-T G.8013]
- 3.1.24 **subnetwork**: See [ITU-T G.805]
- 3.1.25 **termination and adaptation performer** [ITU-T G.7701]
- 3.1.26 **transport entity** [ITU-T G.800]
- 3.1.27 **virtual network (VN)** [ITU-T G.7701]

3.2 Terms defined in this Recommendation

None.

4 Abbreviations, acronyms and symbols

4.1 Abbreviations and acronyms

This Recommendation uses the following abbreviations and acronyms:

1DM	one-way Delay Measurement
2DMM	two-way Delay Measurement
ALM	Alarm reporting
AP	Access Point
ARC	Alarm Reporting Control
AST	Alarm Status ASY Alarm Synchronization
BBE	Background Block Error
CCM	Client Calendar Mismatch

CI	Characteristic Information
CPL	Current Problem List
CTP	Connection Termination Point
CV	Connectivity Verification
DCN	Data Communication Network
DD	Data Dictionary
DEG	Degraded
ECC	Embedded Communication Channel
EMF	Equipment Management Function
ETH	Ethernet
FlexE	Flex Ethernet
FMM	FlexE Map Mismatch
FOP-CM	Failure Of Protocol-Configuration Mismatch
FOP-NR	Failure Of Protocol-No Response
FOP-PM	Failure Of Protocol-Provisioning Mismatch
FOP-TO	Failure Of Protocol-Time Out
FwEP	Forwarding End Point
GIDM	Group Identifier Mismatch
GNE	Gateway Network Element
IP	Internet Protocol
IPv6	Internet Protocol version 6
LLDP	Link Layer Discovery Protocol
LOB	Loss of Basic
LOBA	Loss of Basic message Alignment
LOCS	Loss of Client Signal
LOCV	Loss of Connectivity Verification
LOF	Loss of FlexE Overhead Frame
LOG	Logging
LOL	Loss of Lane alignment
LOM	Loss of FlexE overhead Multi-frame
LTP	Logical Termination Point
LP	Layer Protocol
M	Modulator
MAC	Media Access Control
M-AI	Modulator Adapted Information
MC	Management and Control

MCC	Management Communication Channel
MCS	MC System
MI	Management Information
MP	Management Point
MTN	Metro Transport Network
MTNP	Metro Transport Network Path
MTNS	Metro Transport Network Section
NE	Network Element
NEA	Network Element Alarm
NEF	Network Element Function
NMC	Network Media Channel
NMCG	Network Media Channel Group
OCI	Open Connection Indication
OPS	Operational State
OSPFv3	Open Shortest Path First version 3
OTSi	Optical Tributary Signal
OTSiG	Optical Tributary Signal Group
OUI	Organizationally Unique Identifier
PDU	Protocol Data Unit
PHY	Physical layer
PLM	Payload Mismatch
PM	Performance Management
PMC	Performance Monitoring Clock
PRS	Persistency
REP	Reportable failure
RPF	Remote Physical layer Fault
RTC	Real-Time Clock
RTR	Reset Threshold Report
SES	Severely Errored Second
SEV	Severity
SSF	Server Signal Fail
STA	Station Alarm
TAN	Telecommunication Management network Alarm event Notification
TEP	Telecommunication management network Event Pre-processing
TIM	Trail trace Identifier Mismatch
TLV	Type-Length-Value

TMN	Telecommunication Management Network
TR	Threshold Report
TT	Trail Termination
TTI	Trail Trace Identifier
TTP	Trail Termination Point
UAS	Unavailable Second
UML	Unified Modelling Language
UNA	Unit Alarm
VLAN	Virtual Local Area Network
VN	Virtual Network

4.2 Symbols

A	adaptation function
AcCA	accepted calendar switch acknowledge
AcCC	accepted client calendar
AcCCA	accepted client calendar A
AcCCB	accepted client calendar B
AcCR	accepted calendar switch request
AcFlexEMAP	accepted Flex Ethernet MAP
AcGID	accepted group identification
AcIID	accepted instance identification
AcPT	accepted payload type
AcTI	accepted trail trace identifier
APS	automatic protection switching
C	connection function
DEGM	degraded monitor period
DEGTHR	degraded threshold
DS	defect second
EBC	errored block count
ExCCA	expected client calendar A
ExCCB	expected client calendar B
ExDAPI	expected destination access point identifier
ExFlexEMAP	expected Flex Ethernet MAP
ExGID	expected group identification
ExSAPI	expected source access point identifier
ExtCMD	external command
f	far end

F_DS	far-end defect second
F_EBC	far-end errored block count
F_FD	far-end frame delay
GetAcTI	get accepted trail trace identifier
MTN.MN	MTN management network
MTN.MSN	MTN management subnetwork
MTN.NE	MTN network element
n	near end
N_DS	near-end defect second
N_EBC	near-end errored block count
N_FD	near-end frame delay
SD	signal degrade
Sk	sink
So	source
TIMActDis	trail trace identifier mismatch consequent actions disabled
TIMDetMo	trail trace identifier mismatch detection mode
TxCA	transmitted calendar switch acknowledge
TxCC	transmitted client calendar
TxCCA	transmitted client calendar A
TxCCB	transmitted client calendar B
TxCR	transmitted calendar switch request
TxFlexEMAP	transmitted Flex Ethernet MAP
WTR	wait-to-restore

5 Conventions

5.1 Information modelling conventions

5.1.1 Unified modelling language conventions

See clause 5.1 of [ITU-T G.7711].

5.1.2 -Model artefact lifecycle stereotypes conventions

See clause 5.2 of [ITU-T G.7711].

5.1.3 Forwarding entity terminology conventions

See clause 5.3 of [ITU-T G.7711].

5.1.4 Conditional package conventions

See clause 5.4 of [ITU-T G.7711].

5.1.5 Pictorial diagram conventions

See clause 5.5 of [ITU-T G.7711].

6 MTN management and control architecture

6.1 Relationship between the management and control system, MTN.MN and MTN.MSN

The management and control (MC) system described in [ITU-T G.7701] and [ITU-T G.7718] is applicable to MTN to perform the management and control of the MTN network resources. The MC components and functions for control purposes are specified in [ITU-T G.7701], [ITU-T G.7702] and [ITU-T G.7703]. The MC components and functions for management purposes are specified in [ITU-T G.7710].

The MTN management network (MTN.MN) could be partitioned into MTN management subnetworks (MTN.MSNs) as described in clause 6.1.1 of [ITU-T G.7710].

Figure 6-1 shows an example of MTN management and control network architecture. The data communication network (DCN) between these network elements (NEs) is specified in [ITU-T G.7712].

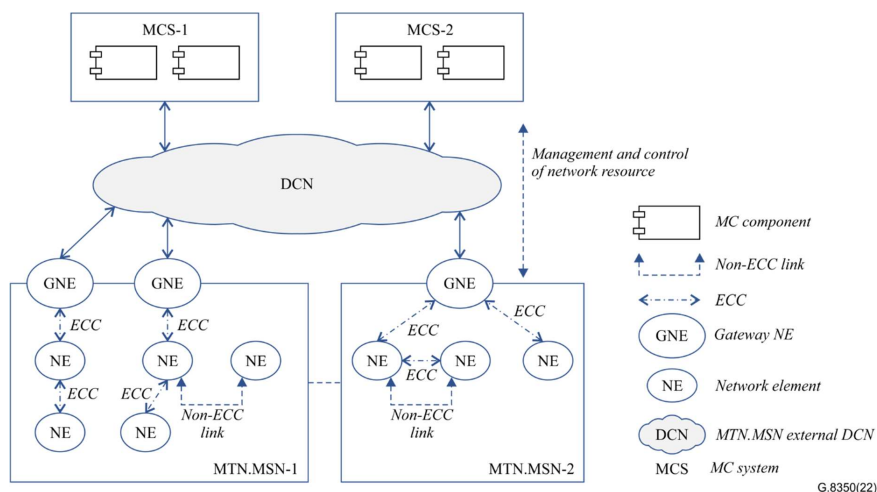

Figure 6-1 – Example of MTN management and control network architecture

6.2 Metro transport network section layer connectivity verification function and interface distinguishing function

The metro transport network section (MTNS) connectivity verification (CV) information and MTNS/Flex Ethernet (FlexE) interface-distinguishing information are carried by link layer discovery protocol (LLDP) organization specific type-length-value (TLV) structures. The specific MTNS CV function and interface distinguishing function, including the TLVs format, transmission channel and coordination method, see Annex A.

6.3 MTN.NE automatic online management

The MTN gateway network elements (GNEs) shown in Figure 6-1 are usually configured manually based on the network planning and then it can establish the session connection with the MC system. After a new NE is deployed in the MTN.MSN, the route between this new NE and the MC system is not reachable yet. The newly deployed MTN.NE could have the automatic online ability to connect with the MC system automatically via the adjacent in-service NEs and GNEs. The detailed process for newly deployed NE to be online automatically is described in Annex B.

7 Fault management

See clause 7 of [ITU-T G.7710] for the generic requirements for fault management. MTN-specific specifications, if needed, are explicitly described.

7.1 Fault management applications

See clause 7.1 of [ITU-T G.7710] for a description of the basic fault management applications.

7.1.1 Supervision

See clause 7.1.1 of [ITU-T G.7710] for a generic description of the supervision applications.

The supervision philosophy for MTN is also based on the concepts underlying the MTN functional model of [ITU-T G.8310].

7.1.1.1 Transmission supervision

See clause 7.1.1.1 of [ITU-T G.7710] for a description of transmission supervision.

7.1.1.2 Quality of service supervision

See clause 7.1.1.2 of [ITU-T G.7710] for a description of quality-of-service supervision.

7.1.1.3 Processing supervision

See clause 7.1.1.3 of [ITU-T G.7710] for a description of processing supervision.

7.1.1.4 Hardware supervision

See clause 7.1.1.4 of [ITU-T G.7710] for a description of hardware supervision.

7.1.1.5 Environment supervision

See clause 7.1.1.5 of [ITU-T G.7710] for a description of environment supervision.

7.1.2 Fault cause validation

See clause 7.1.2 of [ITU-T G.7710] for a description of fault cause validation.

7.1.3 Alarm handling

7.1.3.1 Severity assignment

See clause 7.1.3.1 of [ITU-T G.7710] for a description of severity categories.

7.1.3.2 Alarm reporting control

See clause 7.1.3.2 of [ITU-T G.7710] for a description of alarm reporting control (ARC).

7.1.3.3 Reportable failures

See clause 7.1.3.3 of [ITU-T G.7710] for a description of reportable failures.

7.1.3.4 Alarm surveillance

See clause 7.1.3.4 of [ITU-T G.7710] for a description of alarm surveillance.

7.1.3.4.1 Local reporting

See clause 7.1.3.4.1 of [ITU-T G.7710] for a description of local reporting.

7.1.3.4.2 Telecommunication management network reporting

See clause 7.1.3.4.2 of [ITU-T G.7710] for a description of telecommunication management network (TMN) reporting.

7.2 Fault management functions

See clause 7.2 of [ITU-T G.7710] for a description of fault management inside the equipment management function (EMF).

Figure 7-1 shows the functional model of fault management inside the MTN EMF.

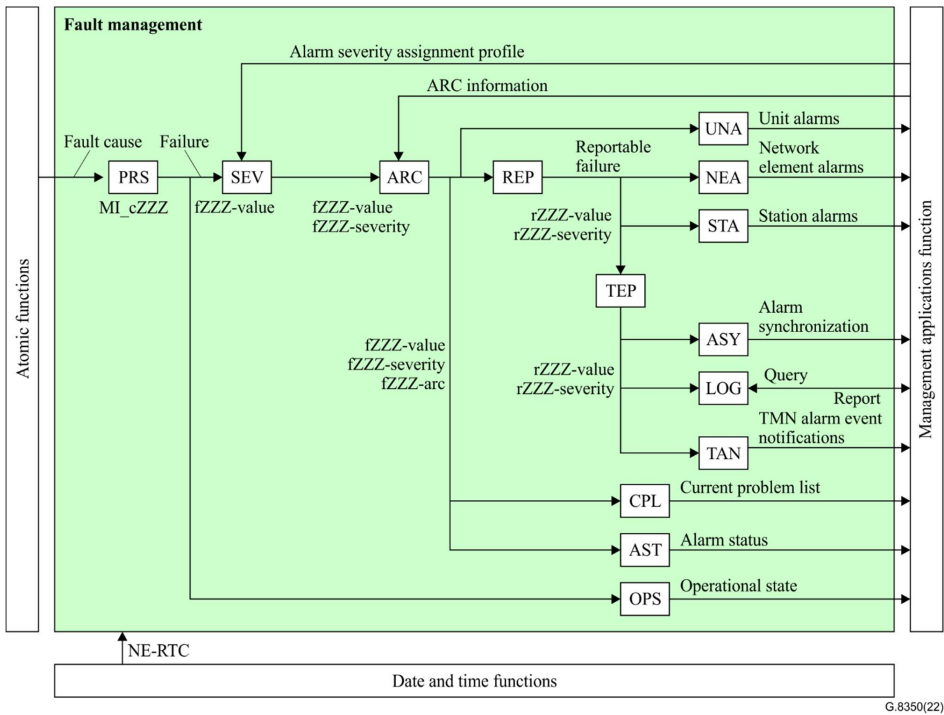

**Figure 7-1 – Fault management within the MTN EMF
(based on Figure 7 of [ITU-T G.7710])**

7.2.1 Fault cause persistency function – PRS

See clause 7.2.1 of [ITU-T G.7710] for a description of the persistency (PRS) function.

For an MTN network element (MTN.NE) that supports the atomic functions listed in Table 7-1, the EMF PRS process shall support the persistency check for the associated fault causes.

Table 7-1 – Inputs/outputs for the fault cause persistency function

Atomic functions	Input (fault cause)	Output (failure)
MTNSy_TT_Sk	cRPF cSSF	fRPF fSSF
MTNP_TT_Sk	cOCI cDEG cTIM cRDI cSSF cLOB cLOCV cLOCS	fOCI fDEG fTIM fRDI fSSF fLOB fLOCV fLOCS
MTNP/ETH_A_Sk	cPLM	fPLM
MTNSy-m/MTNP_A_Sk	cLOL cFMM cGIDM cCCM[1..p] cLOBA[1..p] cTIM	fLOL fFMM fGIDM fCCM[1..p] fLOBA[1..p] fTIM
M-AI/MTNSy_A_Sk	cLOF cLOM	fLOF fLOM
MTNPp_C	Per protection group: cFOP-PM cFOP-CM cFOP-NR cFOP-TO	Per protection group: fFOP-PM fFOP-CM fFOP-NR fFOP-TO
<p>c: cause; CCM: client calendar mismatch; f: failure; FMM: FlexE map mismatch; FOP-CM: failure of protocol-configuration mismatch; FOP-NR: failure of protocol-no response; FOP-PM: failure of protocol-provisioning mismatch; FOP-TO: failure of protocol-time out; GIDM: group identifier mismatch; LOB: loss of basic; LOBA: loss of basic message alignment; LOCS: loss of client signal; LOCV: loss of connectivity verification; LOF: loss of FlexE overhead frame; LOL: loss of lane alignment; LOM: loss of FlexE overhead multi-frame; OCI: open connection indication; PLM; payload mismatch; RPF: remote physical layer fault; SSF: server signal fail; TIM: trail trace identifier mismatch</p>		

7.2.2 Severity assignment function – SEV

See clause 7.2.2 of [ITU-T G.7710] for a description of the severity assignment function.

7.2.3 Alarm reporting control function – ARC

See clause 7.2.3 of [ITU-T G.7710] for a description of the ARC function.

The alarms that can be controlled with this function are specified for each atomic function in [ITU-T G.8321].

In Table 7-2, for each atomic function, a subset of the plausible failures (specified in Table 7-1) is selected, consisting of qualified problems. These qualified problems are recommended, as they are

deemed essential to the operability of the subject-managed entity. Note that for each managed entity, one or more of the qualified problems could then be further selected by the management system to be included in the ARC list for controlling the reporting of alarm for the entity.

A default ARC state is also specified for each managed entity. If the ARC function is supported by the MTN.NE and an ARC state is not explicitly provisioned from the management system for the managed entity, then the default ARC specified in Table 7-2 should be in effect.

For an MTN.NE that supports the atomic functions listed in Table 7-2, the EMF ARC process shall support ARC for the associated fault causes.

Table 7-2 – Alarm reporting control specifications for the optical transport network

Atomic function	Qualified problems	Default ARC state value constraints
MTNSy_TT_Sk	fRPF fSSF	ALM
MTNP_TT_Sk	fOCI fDEG fTIM fRDI fSSF fLOB fLOCV fLOCS	ALM
MTNP/ETH_A_Sk	fPLM	ALM
MTNSy-m/MTNP_A_Sk	fLOL fFMM fGIDM fCCM[1..p] fLOBA[1..p] fTIM	ALM
M-AI/MTNSy_A_Sk	fLOF fLOM	ALM
MTNPp_C	Per protection group: fFOP-PM fFOP-CM fFOP-NR fFOP-TO	ALM
ALM: alarm reporting		

7.2.4 Reportable failure function – REP

See clause 7.2.4 of [ITU-T G.7710] for a description of the REP function.

7.2.5 Unit alarm function – UNA

See clause 7.2.5 of [ITU-T G.7710] for a description of the UNA function.

7.2.6 Network element alarm function – NEA

See clause 7.2.6 of [ITU-T G.7710] for a description of the NEA function.

7.2.7 Station alarm function – STA

See clause 7.2.7 of [ITU-T G.7710] for a description of the STA function.

7.2.8 Telecommunication management network event pre-processing function

See clause 7.2.8 of [ITU-T G.7710] for a description of the TEP alarm function.

7.2.9 Alarm synchronization function – ASY

See clause 7.2.9 of [ITU-T G.7710] for a description of the ASY function.

7.2.10 Logging function – LOG

See clause 7.2.10 of [ITU-T G.7710] for a description of the LOG function.

7.2.11 Telecommunication management network alarm event notification function

See clause 7.2.11 of [ITU-T G.7710] for a description of the TAN function.

7.2.12 Current problem list function – CPL

See clause 7.2.12 of [ITU-T G.7710] for a description of the CPL function.

7.2.13 Alarm status function – AST

See clause 7.2.13 of [ITU-T G.7710] for a description of the AST function.

7.2.14 Operational state function – OPS

See clause 7.2.14 of [ITU-T G.7710] for a description of the OPS function.

Table 7-3 lists the failures that could influence the operational state of the related objects.

For an MTN.NE that supports the atomic functions listed in Table 7-3, the EMF OPS process shall support the operational state for the associated fault causes.

Table 7-3 – Input and output signals of the operational state function for MTN

Atomic function	Failure input (fZZZ-value)	Operational state output (enabled/disabled) of the trail object class
MTNS_TT_Sk	fRPF	Enabled
	fSSF	Enabled
MTNP_TT_Sk	fOCI	Enabled
	fDEG	Enabled
	fTIM	Enabled
	fRDI	Enabled
	fSSF	Enabled
	fLOB	Enabled
	fLOCV	Enabled
	fLOCS	Enabled
MTNP/ETH_A_Sk	fPLM	Disabled
MTNSy-m/MTNP_A_Sk	fLOL	Disabled
	fFMM	Disabled
	fGIDM	Disabled
	fCCM[1..p]	Disabled
	fLOBA[1..p]	Disabled

Table 7-3 – Input and output signals of the operational state function for MTN

Atomic function	Failure input (fZZZ-value)	Operational state output (enabled/disabled) of the trail object class
	fTIM	Disabled
M-AI/MTNSy_A_Sk	fLOF fLOM	Disabled Disabled
MTNpp_C	Per protection group: fFOP-PM fFOP-CM fFOP-NR fFOP-TO	Enabled Enabled Enabled Enabled

8 Configuration management

See clause 8 of [ITU-T G.7710] for generic requirements for configuration management. MTN-specific specifications, if needed, are explicitly described.

8.1 Hardware

See clause 8.1 of [ITU-T G.7710] for a description of hardware management.

8.2 Software

See clause 8.2 of [ITU-T G.7710] for a description of software management.

8.3 Protection switching

See clause 8.3 of [ITU-T G.7710] for a description of protection-switching management.

This function allows a user to provision and monitor the operation of protection processes deployed in an MTNP connection process.

Management information (MI) signals concerning the protection processes are listed in Table 8-3 and communicated between the EMF and the protection process through the management point. According to these MI signals, the EMF generates a corresponding event notification and state report signals to the management application function.

For the protection processes supported by an MTN.NE, the MTN.NE EMF shall support the following management functions:

- provisioning the protection-switching MI;
- retrieving the protection-switching MI;
- notifying the changes of the protection-switching MI;
- receiving the monitored protection-switching MI.

8.4 Trail termination

See clause 8.4 of [ITU-T G.7710] for a description of trail termination (TT) management.

This function allows a user to provision and monitor the operation of the MTNP TT process.

The MI signals listed in Table 8-1 are communicated between the EMF and the MTN TT process across the MP within the MTN.NE.

For the TT functions supported by an MTN.NE, the MTN.NE EMF shall support the following management functions:

- provisioning the TT MI;
- retrieving the TT MI;
- notifying the changes of the TT MI;
- receiving the monitored TT MI.

Table 8-1 – Trail termination-related provisioning and reporting

MI signal	Value range	Default value
MTNP_TT_So Provisioning		
MTNP_TT_So_MI_TxTI	According to [ITU-T G.8321]	Not applicable
MTNP_TT_So_MI_APS_EN	True, false	Not applicable
MTNP_TT_So_MI_1DM_Trigger	True, false [Note]	Not applicable
MTNP_TT_So_MI_2DMM_Trigger	True, false [Note]	Not applicable
MTNP_TT_Sk Provisioning		
MTNP_TT_Sk_MI_APS_EN	True, false	Not applicable
MTNP_TT_Sk_MI_ExSAPI	According to [ITU-T G.8321]	Not applicable
MTNP_TT_Sk_MI_ExDAPI	According to [ITU-T G.8321]	Not applicable
MTNP_TT_Sk_MI_GetAcTI	According to [ITU-T G.8321]	Not applicable
MTNP_TT_Sk_MI_TIMDetMo	According to [ITU-T G.8321]	OFF
MTNP_TT_Sk_MI_TIMActDis	True, false	True
MTNP_TT_Sk_MI_DEGThr	0% .. 100%; see Table 7-1 of [ITU-T G.806]	Not applicable
MTNP_TT_Sk_MI_DEGM	2-10; see Table 7-1 of [ITU-T G.806]	Not applicable
MTNP_TT_Sk_MI_1second	According to [ITU-T G.8321]	Not applicable
MTNP_TT_Sk Reporting		
MTNP_TT_Sk_MI_AcTI	According to [ITU-T G.8321]	Not applicable
NOTE – The MC system should avoid scheduling concurrent DM operations at a node (e.g., if a two-way delay measurement (2DMM) is initiated at the A end of a path, it should not initiate a one-way delay measurement (1DM) or 2DMM at the Z end of that path at the same time).		

8.5 Adaptation

See clause 8.5 of [ITU-T G.7710] for a description of adaptation management.

An access point that has multiple adaptation functions connected to it, thereby allowing different clients to be transported via the server signal, requires a mechanism for the selection of the active client.

The adaptation function allows a user to provision and monitor the operation of the MTN adaptation processes.

The MTNP/ETH_A adaptation function reports on request from the MTN EMF the value of the received and accepted payload type indication signal via the MI_AcPT.

The MI signals listed in Table 8-2 are communicated between the EMF and the adaptation processes across the MP within the MTN.NE.

For the adaptation functions supported by an MTN.NE, the MTN.NE EMF shall support the following management functions:

- provisioning the adaptation MI;
- retrieving the adaptation MI;
- notifying the changes of the adaptation MI.

Table 8-2 – Provisioning and reporting for adaptation functions

MI signal	Value range	Default value
MTNSy-m/MTNP_A_So Provisioning		
MTNSy-m/MTNP_A_So_MI_TxCC (Note)	0, 1 According to [ITU-T G.8321]	By agreement
MTNSy-m/MTNP_A_So_MI_TxCCA (Note)	0..65534 According to [ITU-T G.8321]	Not applicable
MTNSy-m/MTNP_A_So_MI_TxCCB (Note)	0..65534 According to [ITU-T G.8321]	Not applicable
MTNSy-m/MTNP_A_So_MI_TxCR	0, 1 According to [ITU-T G.8321]	Not applicable
MTNSy-m/MTNP_A_So_MI_TxCA	0, 1 According to [ITU-T G.8321]	Not applicable
MTNSy-m/MTNP_A_So_MI_TxTI[1..m]	According to [ITU-T G.8321]	Not applicable
MTNSy-m/MTNP_A_So_MI_TxGID (Note)	1..1048573 According to [ITU-T G.8321]	Not applicable
MTNSy-m/MTNP_A_So_MI_TxFlexEMAP (Note)	String, length 256 According to [ITU-T G.8321]	Not applicable
MTNSy-m/MTNP_A_Sk Provisioning		
MTNSy-m/MTNP_A_Sk_MI_ExCC (Note)	According to [ITU-T G.8321]	Not applicable
MTNSy-m/MTNP_A_Sk_MI_ExCCA (Note)	According to [ITU-T G.8321]	Not applicable
MTNSy-m/MTNP_A_Sk_MI_ExCCB (Note)	According to [ITU-T G.8321]	Not applicable
MTNSy-m/MTNP_A_Sk_MI_ExGID (Note)	According to [ITU-T G.8321]	Not applicable
MTNSy-m/MTNP_A_Sk_MI_ExFlexEMAP (Note)	According to [ITU-T G.8321]	Not applicable
MTNSy-m/MTNP_A_Sk_MI_ExTI[1..m]	According to [ITU-T G.8321]	Not applicable
MTNSy-m/MTNP_A_Sk_MI_TIMDetMo	According to [ITU-T G.8321]	Not applicable
MTNSy-m/MTNP_A_Sk_MI_TIMActDis	According to [ITU-T G.8321]	Not applicable
MTNSy-m/MTNP_A_Sk Reporting		
MTNSy-m/MTNP_A_Sk_MI_AcCC	According to [ITU-T G.8321]	Not applicable
MTNSy-m/MTNP_A_Sk_MI_AcCR	According to [ITU-T G.8321]	Not applicable
MTNSy-m/MTNP_A_Sk_MI_AcCA	According to [ITU-T G.8321]	Not applicable
MTNSy-m/MTNP_A_Sk_MI_AcCCA	According to [ITU-T G.8321]	Not applicable
MTNSy-m/MTNP_A_Sk_MI_AcCCB	According to [ITU-T G.8321]	Not applicable
MTNSy-m/MTNP_A_Sk_MI_AcGID[1..n]	According to [ITU-T G.8321]	Not applicable
MTNSy-m/MTNP_A_Sk_MI_AcIID[1..n]	According to [ITU-T G.8321]	Not applicable
MTNSy-m/MTNP_A_Sk_MI_AcFlexEMAP[1..n]	According to [ITU-T G.8321]	Not applicable
MTNSy-m/MTNP_A_Sk_MI_ActI[1..m]	According to [ITU-T G.8321]	Not applicable

Table 8-2 – Provisioning and reporting for adaptation functions

MI signal	Value range	Default value
MTNP/ETH_A_So Provisioning		
MTNP/ETH_A_So_MI [IEEE 802.3]	See [IEEE 802.3]	Not applicable
MTNP/ETH_A_So Reporting		
MTNP/ETH_A_So_MI [IEEE 802.3]	See [IEEE 802.3]	Not applicable
MTNP/ETH_A_Sk Provisioning		
MTNP/ETH_A_Sk_MI [IEEE 802.3]	See [IEEE 802.3]	Not applicable
MTNP/ETH_A_Sk Reporting		
MTNP/ETH_A_Sk_MI_AcPT	According to [ITU-T G.8321]	Not applicable
MTNP/ETH_A_Sk_MI [IEEE 802.3]	See [IEEE 802.3]	Not applicable
M-AI/MTNSy_A_So Provisioning		
M-AI/MTNSy_A_So_MI [IEEE 802.3]	See [IEEE 802.3]	Not applicable
M-AI/MTNSy_A_So Reporting		
M-AI/MTNSy_A_So_MI [IEEE 802.3]	See [IEEE 802.3]	Not applicable
M-AI/MTNSy_A_Sk Provisioning		
M-AI/MTNSy_A_Sk_MI [IEEE 802.3]	See [IEEE 802.3]	Not applicable
M-AI/MTNSy_A_Sk Reporting		
M-AI/MTNSy_A_Sk_MI [IEEE 802.3]	See [IEEE 802.3]	Not applicable
NOTE – The EMF shall configure the same value for the MI_Tx** and MI_Ex** signals of the paired MTNSy-m/MTNP_A_So and MTNSy-m/MTNP_A_Sk functions.		

8.6 Connection

See clause 8.6 [ITU-T G.7710] for a description of connection management.

This function allows a user to provision the operation of an MTN connection process.

The MI signals listed in Table 8-3 are communicated from the EMF to the connection process through the MP.

For the connection functions supported by an MTN.NE, the MTN.NE EMF shall support the following management functions:

- provisioning the connection MI;
- retrieving the connection MI;
- notifying the changes of the connection MI.

Table 8-3 – Provisioning and reporting for connection functions

MI signal	Value range	Default value
MTNP_C Provisioning		
MTNP_C_MI_MatrixControl	Connect, disconnect	Not applicable
MTNPP_C Provisioning		
Per protection group:	According to clauses 7 and 8 of [ITU-T G.8331].	
MTNPP_C_MI_WorkingPortId		
MTNPP_C_MI_ProtectionPortId		
MTNPP_C_MI_ProtType	000x, 100x, 101x	0b0000
MTNPP_C_MI_OperType	Revertive, Non-revertive	Not applicable
MTNPP_C_MI_HoTime	0 s to 10 s in steps of 100 ms	Not applicable
MTNPP_C_MI_WTR	5 min to 12 min in steps of 1 min	Not applicable
MTNPP_C_MI_ExtCMD	See clause 19 of [ITU-T G.808.1]	Not applicable
MTNPP_C_MI_SDEnable	True, false	Not applicable

8.7 Degraded thresholds

See clause 8.7 of [ITU-T G.7710] for a description of degraded (DEG) threshold configuration.

8.8 ZZZ_Reported

ZZZ_Reported is not applicable to MTN.NEs.

8.9 Alarm severity

See clause 8.9 of [ITU-T G.7710] for a description of alarm severity configuration functions.

8.10 Alarm reporting control

See clause 8.10 of [ITU-T G.7710] for a description of ARC configuration functions.

8.11 Performance management thresholds

See clause 8.11 of [ITU-T G.7710] for a description of performance management (PM) threshold configuration functions.

8.12 Tandem connection monitoring activations

Tandem connection monitoring (TCM) is not supported by MTN.

8.13 Date and time

The date and time functions within the MTN EMF comprise the local real-time clock (RTC) function and the performance monitoring clock (PMC) function. The message communication function within the MTN network element function (NEF) shall be capable of setting the local RTC function.

The date and time values are incremented by a free-running local clock, or by an external timing source. The fault, configuration, accounting, performance and security management functions need date and time information, e.g., to time stamp event reports. They obtain this information from the date and time function.

8.13.1 Date and time applications

Clause 8.13.1 of [ITU-T G.7710] identifies three date and time applications. These are:

- time-stamping;
- PMC signals;
- activity scheduling.

The MTN NEF functional requirements for these applications are specified in clauses 8.13.1.1 to 8.13.1.3.

8.13.1.1 Time stamping

See clause 8.13.1.1 of [ITU-T G.7710] for a description of the time-stamping application.

8.13.1.2 Performance monitoring clock signals

See clause 8.13.1.2 of [ITU-T G.7710] for a description of the PMC signals.

8.13.1.3 Activity scheduling

See clause 8.13.1.3 of [ITU-T G.7710] for a description of the activity scheduling.

8.13.2 Date and time functions

See clause 8.13.2 of [ITU-T G.7710] for a description of the date and time application.

8.13.2.1 Local real-time clock function

The local RTC function is specified in clause 8.13.2.1 of [ITU-T G.7710].

8.13.2.2 Local real-time clock alignment function with external time reference

The local RTC alignment function with an external time reference is specified in clause 8.13.2.2 of [ITU-T G.7710].

8.13.2.3 Performance monitoring clock function

The PMC function is specified in clause 8.13.2.3 of [ITU-T G.7710].

~~8.14 Power monitoring and control~~

~~No requirement of power monitoring and control is specified for MTN.NE.~~

~~8.15~~14 Fault event filtering

See clause ~~8.15-14~~ of [ITU-T G.7710] for a description of fault event filtering.

9 Accounting management

No requirement of accounting management is specified for MTN.NE.

10 Performance management

See clause 10 of [ITU-T G.7710] for the generic requirements for PM. MTN-specific management requirements are described in clauses 10.1 and 10.2.

10.1 Performance management applications

See clause 10.1 of [ITU-T G.7710] for a generic description of PM applications.

10.1.1 Concepts of near-end and far-end

See clause 10.1.1 of [ITU-T G.7710] for a description of near-end and far-end concepts.

10.1.2 Maintenance

See clause 10.1.2 of [ITU-T G.7710] for a description of PM for maintenance.

10.1.3 Bringing-into-service

See clause 10.1.3 of [ITU-T G.7710] for a description of bringing-into-service.

10.1.4 Quality of service

See clause 10.1.4 of [ITU-T G.7710] for a description of quality of service.

10.1.5 Availability

See clause 10.1.5 of [ITU-T G.7710] for a description of availability.

10.1.6 Reporting

See clause 10.1.6 of [ITU-T G.7710] for a description of reporting.

As soon as a threshold is reached or crossed in a 15 min or 24 h period for a given performance measurement, a threshold report (TR) is generated.

As an option for 15 min periods, an alternative method of threshold reporting can be used. When, for the first time, a threshold is reached or crossed for a given performance measurement, a TR is generated. No TRs will be generated in subsequent 15 min periods until the value of the performance measurement falls below a specific threshold. Then, a reset threshold report (RTR) is generated.

Performance data shall be reportable across the network element/operations system (NE/OS) interface automatically upon reaching or crossing a performance-monitoring threshold.

10.1.6.1 Performance data collection

See clause 10.1.6.1 of [ITU-T G.7710] for a generic description of performance data collection.

Counter-based performance data collection refers to the measurement counting associated with each of the performance measurements and any additional performance parameter specified in this Recommendation.

Two types of performance data collection are possible.

- A collection as specified in [ITU-T M.2120], i.e., based on information of each direction of transport independently. This type is also referred to as performance data collection for maintenance purposes.
- The collection as specified in [ITU-T G.826], i.e., based on information of both directions of transport together. This type is also referred to as performance data collection for error performance assessment purposes.

Counts are taken over fixed time periods of 15 min and 24 h. Counting is stopped during unavailable time.

Gauge-based performance data collection refers to the measurement gauge crossings associated with each of the performance measurements and any additional performance parameter specified in this Recommendation.

Performance history data is necessary to assess the recent performance of transmission systems. Such information can be used to sectionalize faults and to locate the source of intermittent errors.

Historical data, in the form of performance measurement, may be stored in registers in the NE or in mediation devices associated with the NE. For specific applications, e.g., when only quality of service alarms are used, historical data may not be stored.

All the history registers shall be time stamped.

The history registers operate as follows.

- 15 min registers.

The history of the 15 min monitoring is contained in a stack of 16 registers per monitored measurement. These registers are called the recent registers.

Every 15 min, the contents of the current registers are moved to the first of the recent registers. When all 15 min registers are used, the oldest information will be discarded.

- 24 h registers

The history of the 24 h monitoring is contained in a single register per monitored measurement. This register is called the recent register.

Every 24 h, the contents of current registers are moved to the recent register.

10.1.6.2 History storage suppression

See clause 10.1.6.2 of [ITU-T G.7710] for a description of history storage suppression.

10.1.7 Thresholding

A thresholding mechanism can be used to generate an autonomous measurement report when the performance of a transport entity falls below a predetermined level. The general strategy for the use of thresholds is described in [ITU-T M.20]. The thresholding mechanism is applicable only to the maintenance-based collection.

See clause 10.1.7 of [ITU-T G.7710] for a description of thresholding.

10.1.7.1 Threshold setting

The thresholds may be set in the NE via the OS. The OS shall be able to retrieve and change the settings of the 15 min and 24 h thresholds.

The threshold values for measurements evaluated over the 15 min period should be programmable within the specified range.

10.1.7.2 Threshold reporting

As soon as a threshold is reached or crossed in a 15 min or 24 h period for a given performance measurement, a TR is generated.

As an option for 15 min periods, an alternative method of threshold reporting can be used. When, for the first time, a threshold is reached or crossed for a given performance measurement, a TR is generated. No TRs will be generated in subsequent 15 min periods until the value of the performance measurement falls below a specific threshold. Then, an RTR is generated.

Performance data shall be reportable across the NE/OS interface automatically upon reaching or crossing a performance-monitoring threshold.

10.1.7.3 Evaluation for counters

See clause 10.1.7.3 of [ITU-T G.7710] for a generic description.

10.1.7.4 Evaluation for gauges

See clause 10.1.7.4 of [ITU-T G.7710] for a generic description.

10.1.8 Delay measurement requirements

- 1) MTN delay measurement support dual-ended delay measurement (i.e., 1DM) and single-ended delay measurement (i.e., 2DMM/two-way delay measurement response).
- 2) 1DM_Trigger and 2DMM_Trigger in the source atomic function will trigger 1DM and 2DMM respectively. 1DM and 2DMM are exclusive; the concurrent trigger should be avoided.
- 3) On-demand delay measurement must be supported. [The specific requirements for EMF include:](#)
 - [On-demand delay measurement jobs are managed at MTNP TTPs \(establish, modify\).](#)
 - [On-demand delay measurement can be done to support one or several triggers and the following parameters could be configured.](#)
 - [Start time: defines the start of the on-demand session.](#)
 - [Stop time: defines the stop of the on-demand session.](#)
 - [Session Duration: Stop time – Start time, read-only.](#)
 - [Trigger period: defines the period for triggering the DM process.](#)
 - [Reporting period: defines the period for reporting the DM results to MC system.](#)

The process for EMF to trigger the DM is illustrated in Figure 10-1:

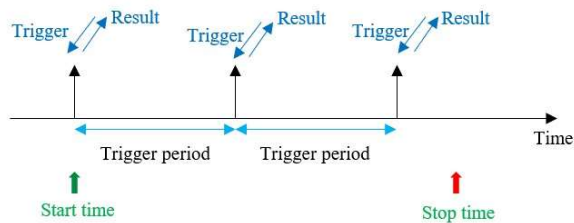

Figure 10-1 – Process for EMF to trigger the DM

[In the session duration, EMF could trigger the DM periodically. At the starting of every trigger period, the EMF will send MI_1DM_Trigger or MI_2DMM_Trigger signal to the MTNP_TT_So function and will also receive the DM result\(s\) for every DM trigger signal correspondingly. The trigger period, start time, stop time could be configured and modified, and the stop time \$\geq\$ start time. When the period is not configured, the trigger will only be sent once. After receiving the DM results, EMF could periodically report the results to the MC system based on the configured report period.](#)

10.2 Performance management functions

See clause 10.2 of [ITU-T G.7710] for generic requirements of PM functions.

MTN.NE provides the PM management information in Table 10-1.

Table 10-1 – PM management information

PM management information	MTN function	PM current data and history data collected in EMF
MTNP_TT_Sk_MI_pN_EBC MTNP_TT_Sk_MI_pN_DS MTNP_TT_Sk_MI_pF_EBC MTNP_TT_Sk_MI_pF_DS MTNP_TT_Sk_MI_1DM_result[N_FD] MTNP_TT_Sk_MI_2DM_result[N_FD, F_FD, B_FD]	MTNP_TT_Sk	MTNP_TT_Sk: nSES, fSES, {UAS nUAS, fUAS} (Note), nBBE, fBBE, See clause 9.2.1.2 of [ITU-T G.8321] for 1DM_N_FD, 2DM_F_FD, 2DM_N_FD, 2DM_B_FD
M-AI/MTNSy_A_Sk_MI_[IEEE 802.3]	M-AI/MTNSy_A_Sk	see [IEEE 802.3]
BBE: background block error; f: far end; n: near end; SES: severely errored second; UAS: unavailable second NOTE – {UAS nUAS, fUAS} means bidirectional UAS or unidirectional "nUAS and fUAS".		

The EMF shall support the following functions:

- collecting MTN layer-specific current PM data as specified in Table 10-1;
- collecting MTN layer-specific history PM data as specified in Table 10-1;
- resetting of the MTN layer-specific current PM data registers;
- reporting MTN layer-specific current PM data at the maturity of the monitoring time interval;
- on-demand retrieval of the collected MTN layer-specific PM data;
- setting of the threshold of the monitored MTN layer-specific PM data collection;
- reporting of threshold crossing for the collected MTN layer-specific current PM data;
- notifying the change of the threshold of the monitored MTN layer-specific PM data collection.

11 Security management

See clause 11 of [ITU-T G.7710] for generic requirements of security management.

12 Network-level management and control requirements for MTN

12.1 Topology management

The topology resources of the MTN.MSN could be provided to the MC system. The administrator of the MC system could constitute a complete MTN.MN topology based on the MTN.MSN topologies.

The MTN.NE and its MTNS links within an MTN.MSN can be discovered by using the link automatic discovery protocol. The links between the MTN.MSN can be configured by the administrator. When the status of the MTN.NE or link is changed, the status is reported to the MC system. Then the MTN.MN topology can be shown by the MC system with the latest status of the MTN.NE and links. The MC components discovery agent, termination and adaptation performer and link resource manager in [ITU-T G.7701] enable the discovery and allocation of link resources, which the routing controller uses to form a topology view.

The MC system should support the presentation of the topology of the MTNP layer and MTNS layer in hierarchy. An MTNP topological resource includes the MTNP layer network, MTNP subnetwork, MTNP link and MTNP access groups. MTNS topological resources include MTNS layer network and MTNS access groups.

For a specific client, the MC system only shows the MTN topology with the MTN resources that have been allocated to the client and could support their selection of the way to present the topologies.

12.2 Connectivity control

As described in [ITU-T G.8310], the MTNP layer provides channel forwarding for Ethernet media access control (MAC) frames. The MTNP layer network should support MTNP network connection rearrangement for flexible network routing. The MTNP subnetwork may represent the aggregation of contained subnetworks and links or, it may represent the limit of subnetwork recursion, which is a matrix.

A MTNP subnetwork may provide a subnetwork connection directly between MTNP forwarding end points (FwEPs) without adaptation to an MTNS layer. The MC system should support the lifecycle management of the MTNP network connection between two MTNP FwEPs, including the following.

- Creation of an MTNP network connection based on the configured routing constraints, for example, the MTN.NEs, which must or must not be passed through. As in Figure 7-2 of [ITU-T G.8310], MTNP network connection may include the MTNP FwEPs, MTNP subnetwork connections, MTNP link connections and MTNP FPs. These resources for MTNP network connection are decided by the path calculation based on the routing constraints.
- Update of an MTNP network connection, which includes adjustment of: the bandwidth; operation, administration, maintenance; resilience constraints configuration; routing constraints; etc.
- Deletion of an MTNP network connection and release the resources occupied by this network connection.

12.3 Virtual network management

As described in [ITU-T G.7702], a virtual network (VN) is a virtualization of [ITU-T G.800] layer network resources. A virtualization is an abstraction and subset whose selection criterion is dedication of resources to a particular client or application MTNP layer network resources could be abstracted and virtualized to constitute the MTN VN. The VN could be recursive. From the viewpoint of the client, the VN allocated to the client is a complete network. How this complete network is virtualized and the number of recursions are agnostic to the client.

The MC system should support lifecycle management of the MTN VN, including the following.

- The administrator could create dedicated VNs for a client based on specific requirements, such as bandwidth or latency. The administrator or client could create another VN based on the lower layer VN for a specific purpose, e.g., to support different services.
- Update the capability requirement of the VN, including the bandwidth, latency etc.
- Delete the VN and release all the resources allocated to this VN.

12.4 Path computation

The MC system should support the path computation request for MTNP layer connection with the routing constraint and resilience constraint. The routing constraint should include the calculation policy (e.g., min-hop, bandwidth or min-latency), the explicitly included or excluded MTN node, the explicitly included or excluded MTN interface, and the explicitly included/excluded FlexE group etc.

The MC system should support the computation of paths for MTNP layer connection based on available network resources. The MC system should support the initiation of a path computation request during the creation of a MTNP layer connection or the restoration of a failure, or before a MTNP layer connection request by the user to check the possible paths for the MTNP layer connection.

12.5 Notification management

The MC system should support the subscription of the notification for alarms or events occurring in an MTN network. The MC system should send notification to the user who has subscribed after the notification is received by the notification component. Notification subscription includes the establishment, maintenance, history retrieval, modification and deletion of a subscription. The MC system maintains a historical log of the notifications that have been sent to its user. The user should be able to retrieve the history log from MC system.

The MC system should support the analysis of the relationship between the MTN resource that generates alarms and the (virtual) MTNP resources occupied by MTNP network connections handled by the MC system, to determine whether the alarm has an impact on the MTNP network connections managed by the MC system. The user should be able to acquire all alarm notifications related to a specified MTNP network connection from the MC system.

12.6 Performance management

The MC system should support the management of the performance measurement task for MTNP network connections, including the establishment, modification and deletion of a performance measurement task for the performance data. The performance threshold can be set for a single or every MTNP network connection. The MC system can monitor performance based on the performance threshold. The user should be able to retrieve performance data for MTNP network connections on demand from the MC system.

The MC system should ensure all monitoring parameters are correctly configured to MTN.NEs, e.g., the MC system should avoid the DM trigger operation conflict between MTN.NEs at the A and Z end of a MTNP layer connection.

13 Information model for metro transport networks

13.1 Overview of the model

In this Recommendation, managed resources and management support resources are modelled as objects in the information model. The management view of a resource is a managed object. This Recommendation specifies the properties of the resources visible for management. Objects with similar properties are grouped into object classes. An object instance is an instantiation of an object class. The properties of an object include the behaviour, attributes and operations that can be applied to the object. An object instance is characterized by its object class and may possess multiple attribute types and associated values. In the protocol-neutral model, object classes are represented as unified modelling language (UML) classes.

Object classes, attribute types and operations are specified to communicate network management messages between systems. They need not be related to the structure of data stored within those systems.

Figure 13-1 and Figure 13-2 show the mapping between the MTN-managed object classes and the MTN atomic functions specified in [ITU T G.8310].

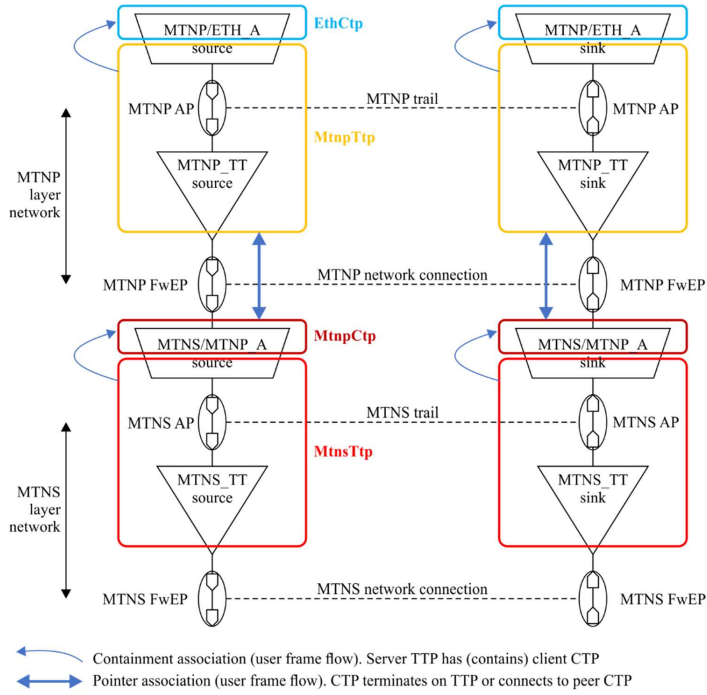

G.8350(22)

Figure 13-1 – Overview of object class mapping to MTN atomic functions of digital layers
 (Based on Figure 7-1 of [ITU-T G.8310])

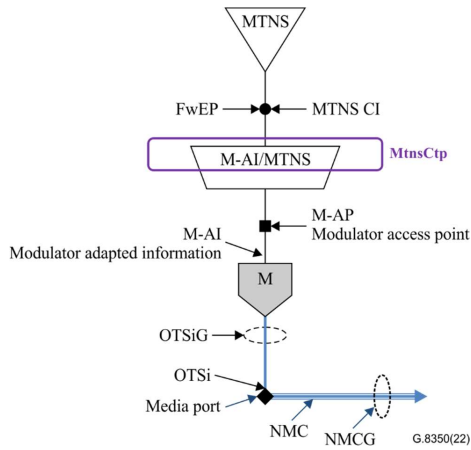

G.8350(22)

Figure 13-2 – Overview of object class mapping to MTN atomic functions that associated with media layer
 (Based on Figure 8-1 of [ITU-T G.8310])

The MTNS could be carried by a group of two or more Ethernet interfaces. This could be modelled by expanding the adaptation function described in clause 10 of [ITU-T G.8321]. Figure 13-1 Figure 13-3 shows the mapping between the MTN managed object classes and the MTN atomic functions defined in [ITU T G.8321]. The MTNS TTP Group is associated with the adaptation function in the inverse mux sublayer.

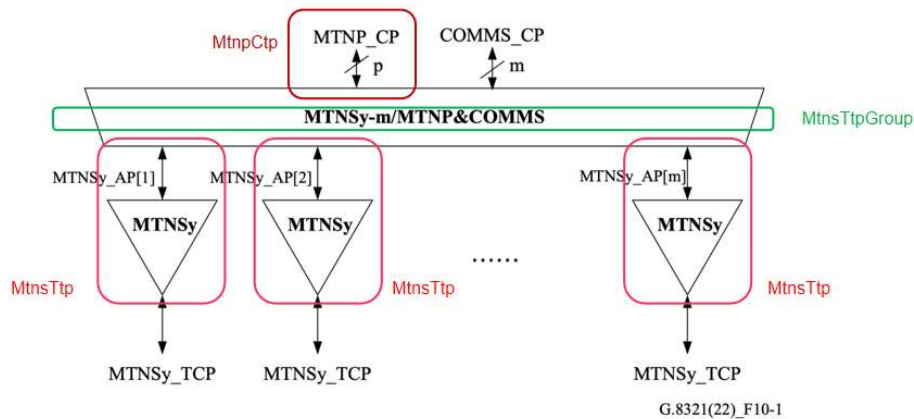

Figure 13-3 Overview of MTNS TTP Group object class mapping to MTN atomic functions
(Based on Figure 10-1 of [ITU-T G.8321])

13.2 Model fragments

13.2.1 High-level overview model

The UML diagram shown in Figure 13-3-4 provides a high-level overview of most of the MTN specific managed object classes without showing the details, such as the attributes and operations of the object classes.

More detailed class diagrams for the individual fragments of the model appear in Figure 13-4-5 to Figure 13-8-15, which also show attributes and operations.

The object class *MtnConstraintDomain* is pruned and refactored from ITU-T G.7711 *ConstraintDomain* to represent the MTN.NE and it is «ExtendedComposite»¹ with the MTN specific attributes defined in the *MtnpConstraintDomainPac* abstract object class.

¹ The «ExtendedComposite» aggregation means that the extending class will never be explicitly instantiated (i.e., are abstract), but that the attributes defined by the extending class will be transferred to the class being extended at runtime.

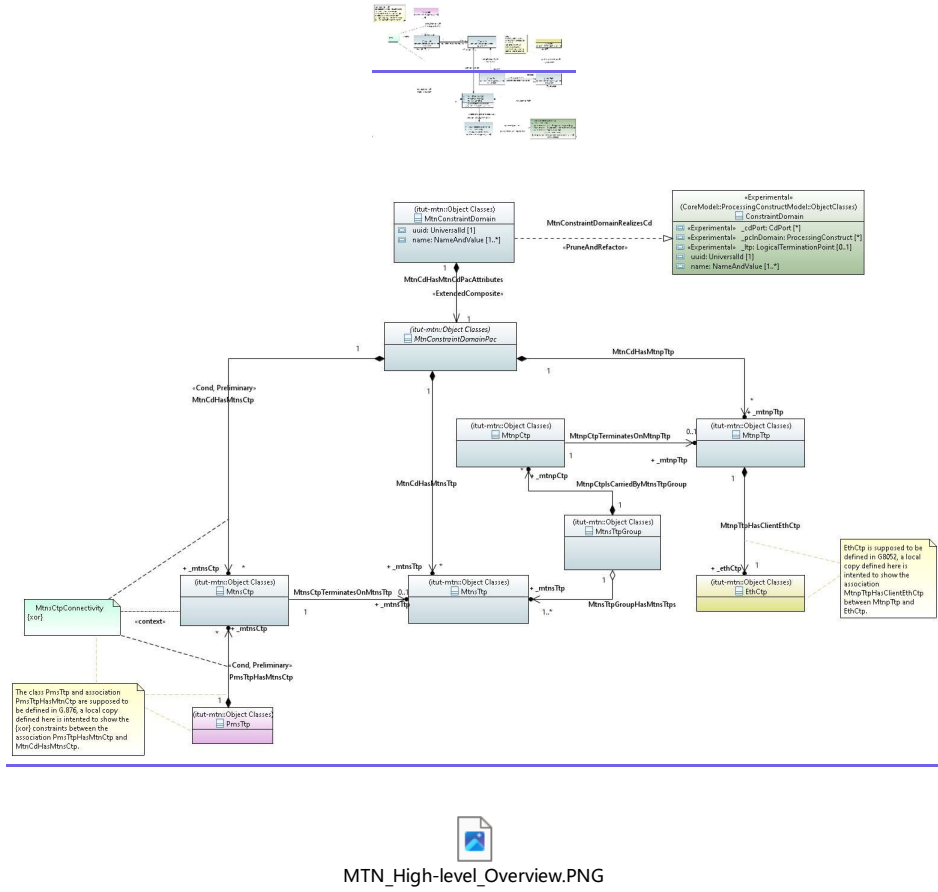

Figure 13-3-4 – MTN model high-level overview

See Table 13-1 for the descriptions of the object classes representing the adaptation and termination functions in the MTNP and MTNS layers.

If the server trail termination point (TTP) of the `MtnsCtp` is within the scope of the implementation, the `MtnsCtp` is contained by it (i.e., `OtsiaTtp`). This relationship is represented by the `OtsiaTtpHasClientMtnsCtp` containment association. If the server TTP of the `MtnsCtp` is outside the scope of the implementation, containment of `MtnsCtp` could be modelled by the MTN Constraint domain. This relationship is represented by the `MtnCdHasMtnsCtp`. The associations `OtsiaTtpHasClientMtnsCtp` and `MtnCdHasMtnsCtp` have the exclusive OR constraint.

Table 13-1 – Object classes for adaptation and termination model

Object classes	Basic classes in [ITU-T G.7711]	Descriptions	Related Recommendations
MtnsCtp (MTNS connection termination point)	LogicTerminationPoint LayerProtocol	Adaptation functions of MTNS layer, including adaptation between MTNS and modulator-adapted information (M-AI) and forward error correction function.	[ITU-T G.8310] [ITU-T G.8321]
MtnsTtp (MTNS trail termination point)		Termination functions related with a PHY of MTN Section layer including the validation of connectivity integrity.	
MtnpCtp (MTNP connection termination point)		Adaptation functions of MTN Path layer includes mapping 664B/66B blocks of the MTNP CI into a defined number of calendar slots in a group of PHYs or recovering of the MTNP CI from the assigned calendar slots.	
MtnpTtp (MTNP trail termination point)		Termination functions of MTNP layer including validation of connectivity integrity; assessment of transmission quality; transmission defect detection and indication	
EthCtp (Ethernet connection termination point)		Adaptation functions of Ethernet layer includes encoding the client MAC frame into a contiguous sequence of 64B/66B blocks or recovering the client MAC frame from the contiguous sequence of 64B/66B blocks.	
MtnsTtpGroup (A Group of MTNS Trail Termination Point)		Adapted information of a group of PHYs in MTN Section layer which carries the MTN Path layer signals	[ITU-T G.8321]

13.2.2 MTNP fragments

13.2.2.1 MTNP TTP object classes

The MtnpTtp (MTN path trail termination point) object class is derived via pruning and refactoring of the ITU-T G.7711 logical termination point (LTP) and layer protocol (LP) object classes, when LTP has no server layer LTP and it contains only one LP with layerProtocolName = 'MTNP' and terminationState = 'LP_PERMENANTLY_TERMINATED'.

The MtnpTtp object class is «ExtendedComposite» with the MTN technology-specific attributes specified within the *MtnpTtpPac*, *MtnpTtpSourcePac*, *MtnpTtpSinkPac* and *MtnpTtpBidirPac* abstract object classes as shown in Figure 13-45.

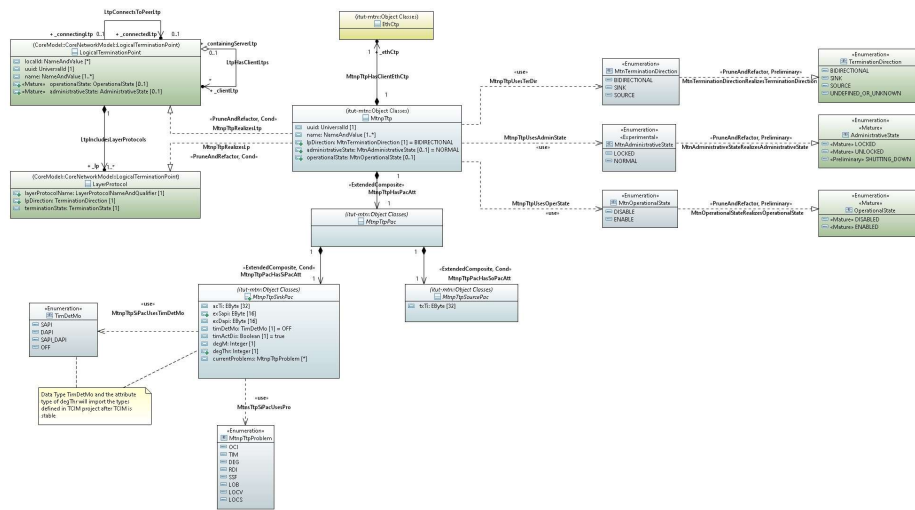
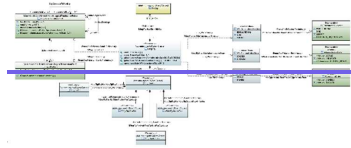

MTNP_TTP_Overview.PNG

Field Code Changed

Figure 13-45 – MTNP TTP overview

13.2.2.2 MTNP connection termination point (CTP) objects classes

The MtnpCtp (MTN path connection termination point) object class is derived via pruning and refactoring of the ITU-T G.7711 LTP and LP object classes, when the LTP has a server LTP and it includes only one LP with layerProtocolName = 'MTNP' and terminationState = 'LP_CAN_NEVER_TERMINATE'.

The MtnpCtp object class is «ExtendedComposite» with the Ethernet-MTN technology-specific attributes specified within the MtnpCtpPac, MtnpCtpSourcePac, MtnpCtpSinkPac and MtnpCtpBidirPac abstract object classes as shown in Figure 13-56.

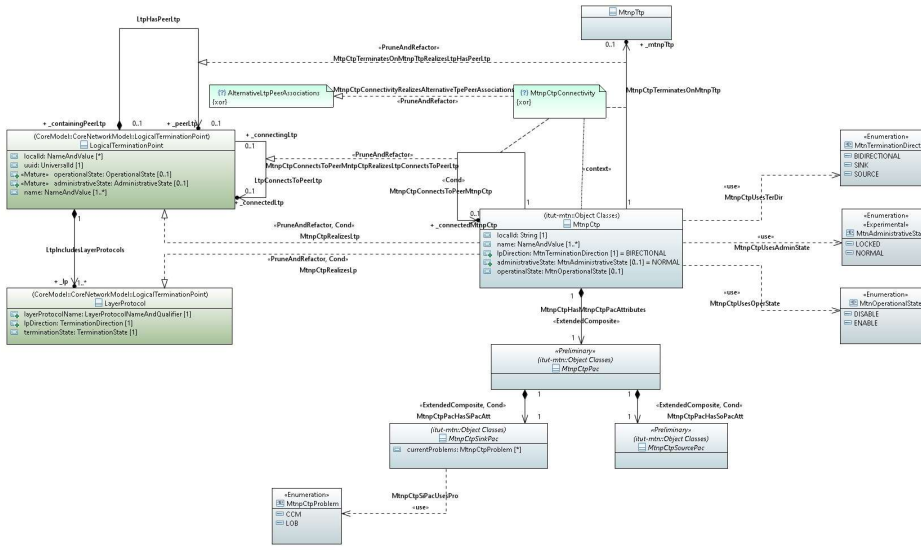
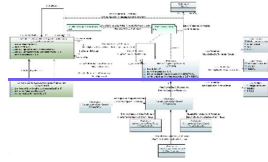



 MTNP_CTP_Overview.PNG

Field Code Changed

Figure 13-56 – MTNP CTP overview

13.2.2.3 MTNP connectivity object classes

The skeleton of the adaptation and termination model is shown in Figure 13-67.

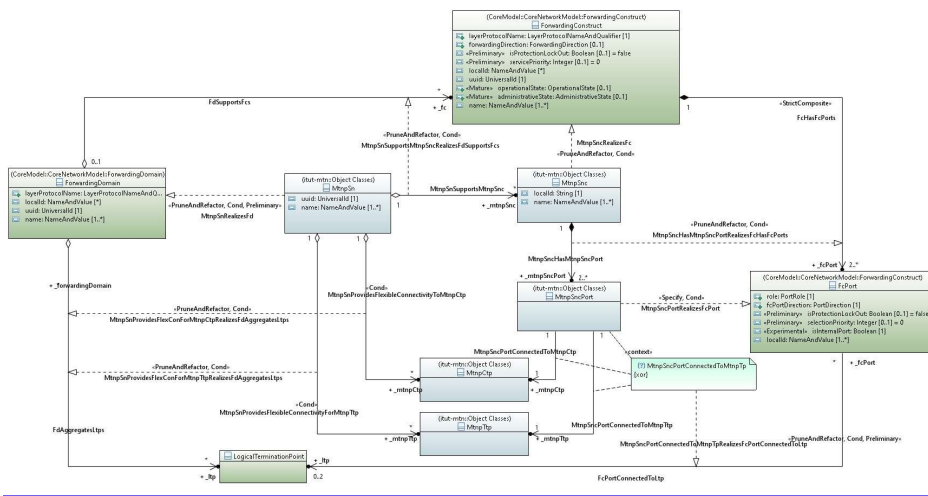
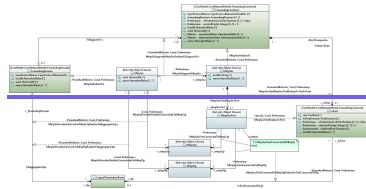

MTNP_Connectivity_Overview.PNG

Field Code Changed

Figure 13-67 – MTNP connectivity overview

13.2.2.4 MTNP trail protection object classes

As shown in Figure 13-78, the MtnpLinearProtectionGroup object class is derived via pruning and refactoring of the ITU-T G.7711 FcSwitch and ControlParameters_Pac object classes and it is «ExtendedComposite» with the MTN trail protection specific attributes specified in the MtnpLinearProtectionPac abstract object class. The MTNP trail protection attributes are set based on [ITU-T G.8331]. The LinearProtectionAction is an interface to receive the commands for switching. Since the MTNP linear protection is end-to-end and individual trail protection, MtnpLinearProtectionPac object class has two associations with the MtnpTtp object class, pointing to the working MTNP TTP instance and protecting the MTNP TTP instance, respectively.

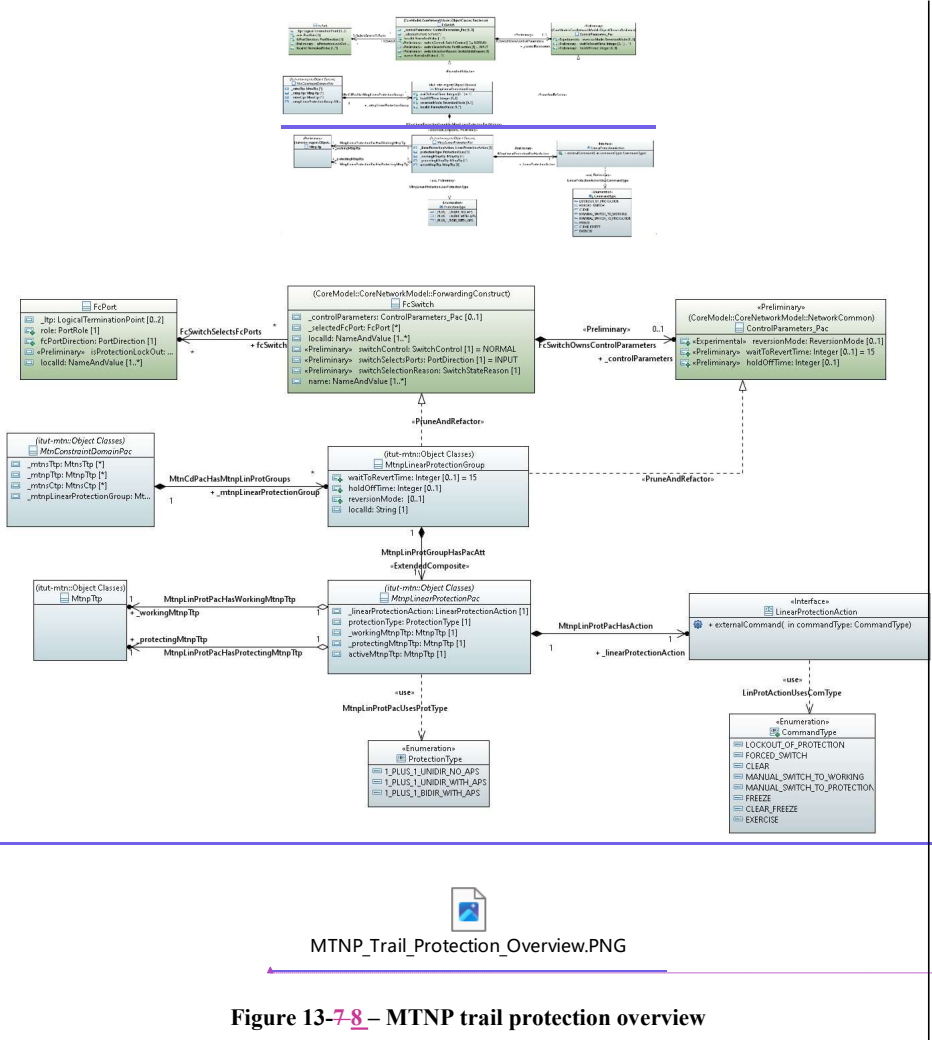

Figure 13-78 – MTNP trail protection overview

13.2.3 MTNS fragments

13.2.3.1 MTNS TTP object classes

The MtnsTtp (MTN section trail termination point) object class is derived via pruning and refactoring of the ITU-T G.7711 LTP and LP object classes, when LTP has no server layer LTP and it contains only one LP with layerProtocolName = 'MTNS' and terminationState = 'LP_PERMENANTLY_TERMINATED'.

The MtnsTtp object class is «ExtendedComposite» with the MTN technology-specific attributes defined within the MtnsTtpPac, MtnsTtpSourcePac, MtnsTtpSinkPac and MtnsTtpBidirPac abstract object classes as shown in Figure 13-89.

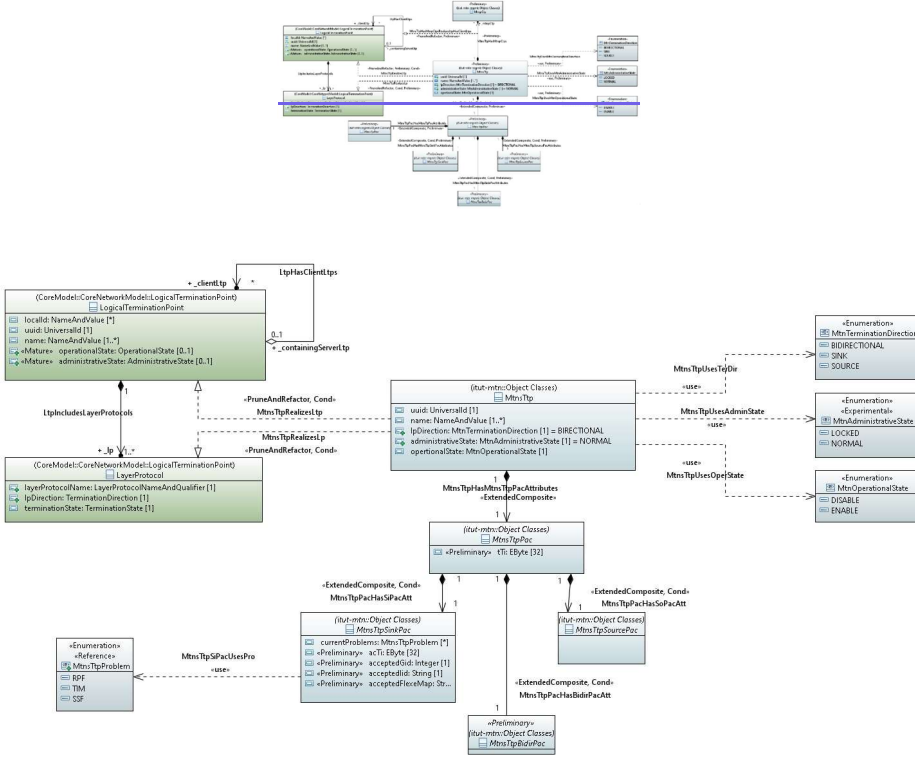

MTNS_TTP_Overview.PNG

Field Code Changed

Figure 13-8-2 – MTNS TTP overview

13.2.3.2 MTNS CTP object classes

The `MtnsCtp` (MTN section connection termination point) object class is derived via pruning and refactoring of the ITU-T G.7711 LTP and LP object classes, when the LTP has a server LTP and it includes only one LP with `layerProtocolName = 'MTNS'` and `terminationState = 'LP_CAN_NEVER_TERMINATE'`.

The `MtnsCtp` object class is «ExtendedComposite» with the Ethernet-MTN technology-specific attributes specified within the `MtnsCtpPac`, `MtnsCtpSourcePac`, `MtnsCtpSinkPac` and `MtnsCtpBidirPac` abstract object classes as shown in Figure 13-910.

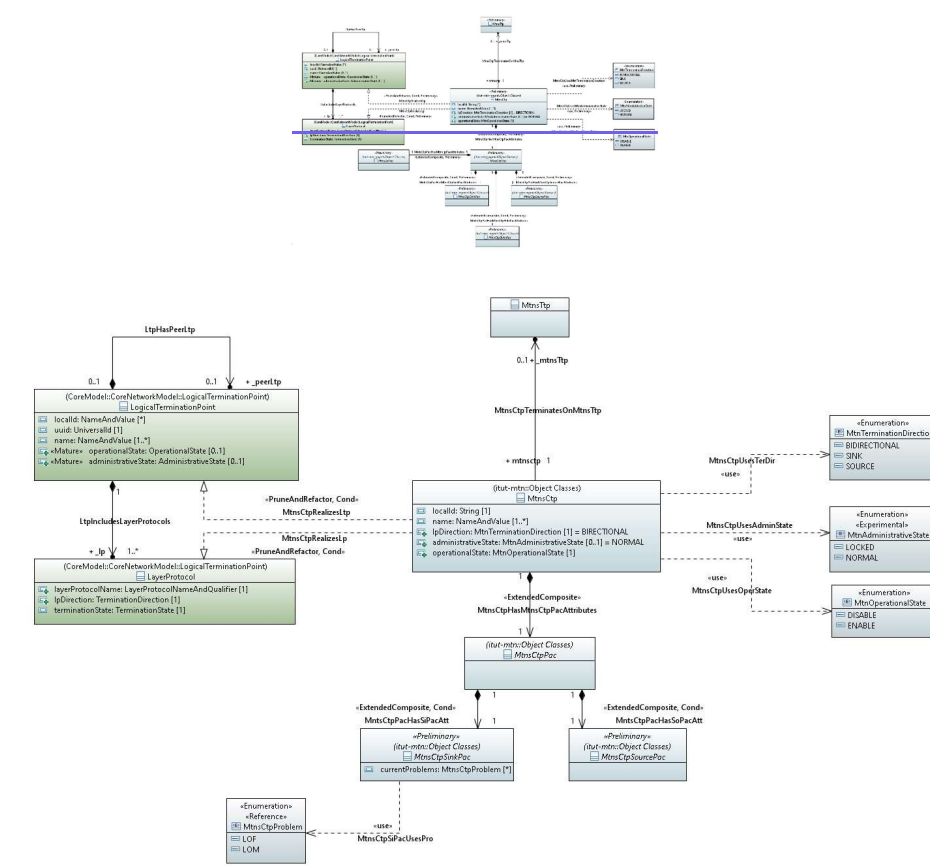

MTNS_CTP_Overview.PNG

Figure 13-9-10 – MTNS CTP overview

13.2.3.3 MTNS TTP Group objects classes

The *MtnsTipGroup* object class representing a group of MTNS TTP is «ExtendedComposite» with the MTN technology-specific attributes specified within the *MtnsTipGroupSinkPac*, *MtnsTipGroupSourcePac* abstract object classes as shown in Figure 13-11.

Field Code Changed

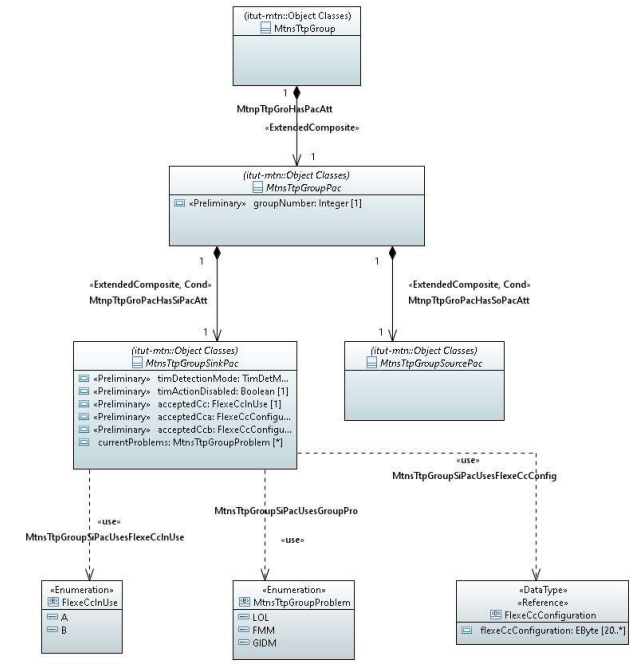

MTNS_TTP_Group_Overview.PNG

Field Code Changed

Figure 13-11 – MTNS TTP Group overview

13.2.4 Performance monitoring (PM) fragment

13.2.4.1 Delay measurement object classes

The following Figure 13-12 and 13-13 provide an overview of the MTNP delay measurement function showing involved atomic functions, management information and managed object classes.

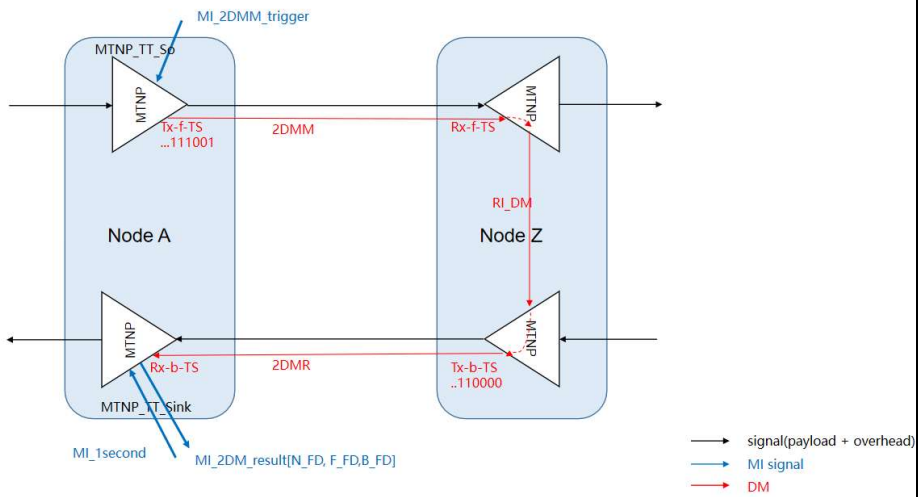

Figure 13-12 single-ended delay measurement function

In single-ended mode, after receiving the trigger (blue MI signal) configured by the MCS, A will send 2DMM to Z, and A will not report the result of 2DM until it receives the 2DMR sent by Z. Node A is both the source and the sink of 2DM.

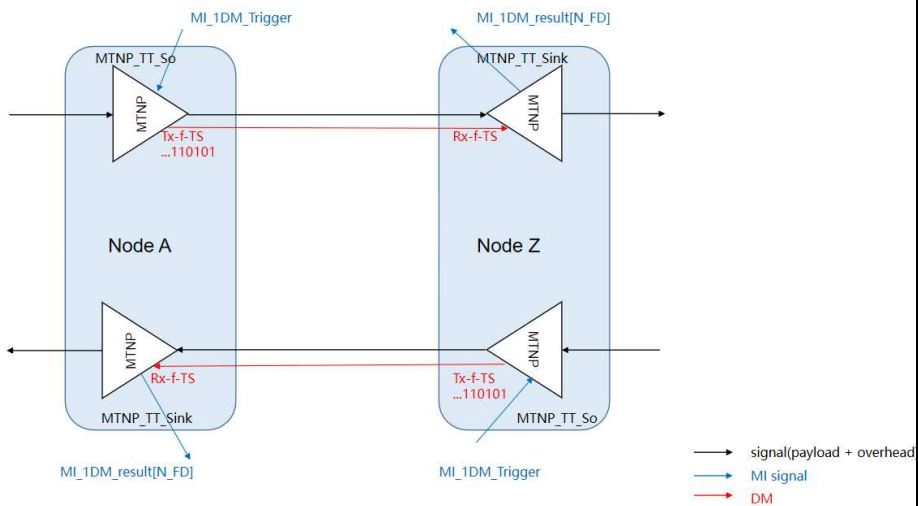
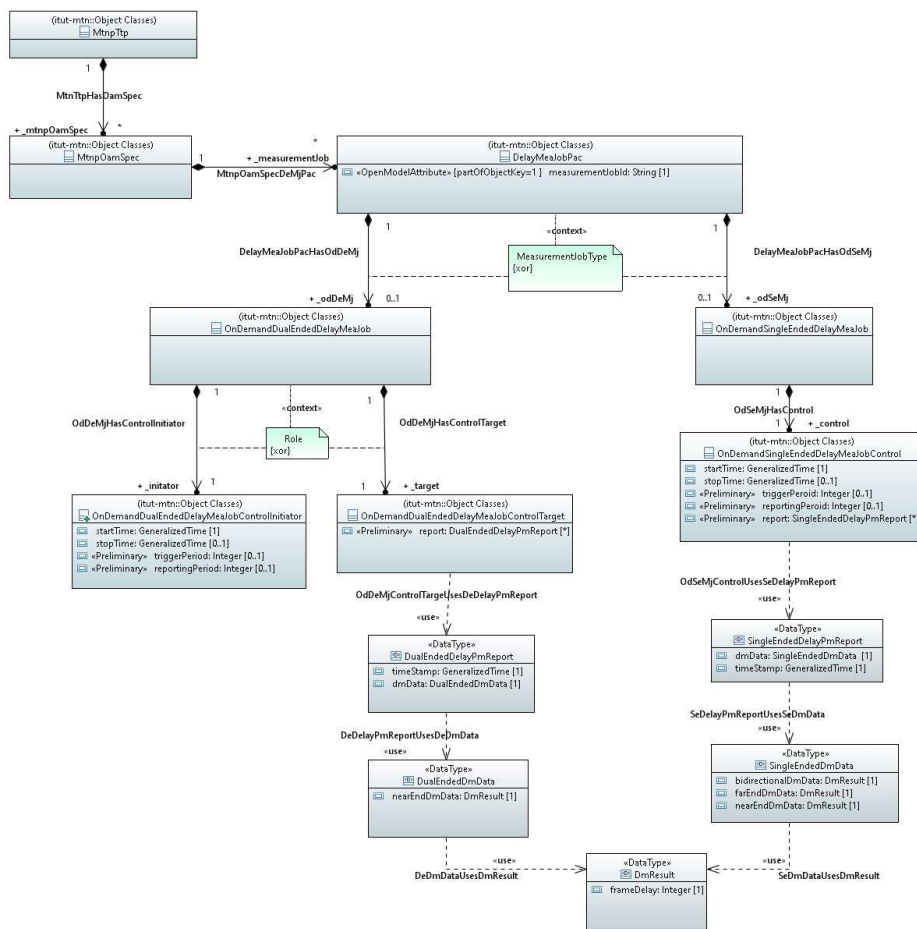

Figure 13-13 dual-ended delay measurement function

In the dual-ended mode, the MCS sends the trigger to the initiator NE respectively to perform unidirectional measurement. The NE that receives the trigger from MCS is the initiator, and the other is the target which sends the result to MCS.

The on-demand DM object classes overview of MTNP is shown in Figure 13-14. The MtnpOamSpec object class is contained in MtnpTtp and it has DelayMeaJobPac to aggregate the OnDemandDualEndedDelayMeaJob or OnDemandSingleEndedDelayMeaJob. The object classes representing the initiator and target are defined to control the dual ended DM job, and the object class to control the single ended DM job is defined as well.



MTNP_DM_Overview.PNG

Figure 13-14 – On-demand MTNP DM overview

Field Code Changed

13.2.4.2 Performance measurements object classes

The MtnpCurrentData and MtnpHistoryData object classes are defined for the performance data generated per 15 minutes or 24 hours and the ThresholdProfile object class is defined for setting the thresholds of the MTNP performance measurements. The overview of MTNP performance measurements is shown in Figure 13-15.

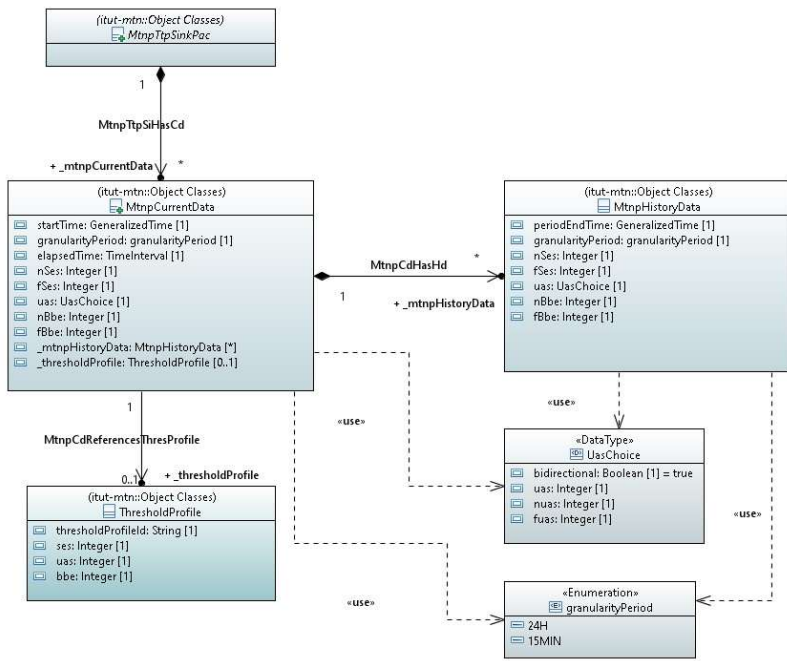

MNTP_PM_overview.PNG

Figure 13-15 –MTNP performance measurements overview

14 UML model file

This Recommendation includes a zip file, which contains the UML model, developed using the Papyrus open-source modelling tool. The file can be downloaded from [this repository](#).

G.8350_v1.0.2_um
l@20231016.zip

Field Code Changed

Field Code Changed



Field Code Changed

This zip file contains the following folders:

- The G.8350 folder, which contains the following files:
 - The Papyrus project file
 - project
 - The .di, .notation, and .uml files of the itut-mtn-mgmt module
 - itut-mtn-mgmt.di
 - itut-mtn-mgmt.notation
 - itut-mtn-mgmt.uml
 - The doc sub-folder, which contains the data dictionary of the G.8350 UML model and the template used to generate the data dictionary
 - The UmlProfiles sub-folder, which contains the UML Profiles that determine the properties of the UML artefacts
 - The OpenModelProfile folder, which contains the .di, .notation, and uml of the open model profile
 - The OpenInterfaceModelProfile folder, which contains the .di, .notation, and uml of the open model interface profile
 - The ProfileLifecycleProfile folder, which contains the .di, .notation, and uml of the profile lifecycle profile
 - The ClassDiagramStyleSheet.css style sheet
 - The diagrams sub-folder, which contains PNG images of all class diagrams.
- The ITU-T G.7711 folder, which contains the ITU-T G.7711 core model that is needed (i.e., imported) by the model associated with this Recommendation.

NOTE 1 – If the imported model has been up-versioned or has changed the module name, then the xmi code of the G.8350 module will need to be updated.

To load the UML model associated with this Recommendation into an Eclipse Papyrus workspace, proceed as follows.

- In the Project Explorer/right click/Import/General/Projects from Folder or Archive/Next/Archive/Select the G.8350 zip file/Open/Select the folders of the models to be loaded (NOTE) / Finish

NOTE 2 – If a supporting (i.e., to be imported by ITU-T G.7711) model already exists in the workspace, do not select it for loading.

NOTE 3 – The UML information models and the open model profile associated with this Recommendation are specified using the Papyrus open-source modelling tool. In order to view and further extend or modify the information model, installation of the open source Eclipse software and the Papyrus tool, which is available at [b-Eclipse-Papyrus], is required. The installation guide for Eclipse and Papyrus can be found in [b-ONF TR-515].

Annex A

LLDP organizationally specific TLVs in MTN

(This annex forms an integral part of this Recommendation.)

As shown in Figure A.1, two adjacent MTN.NEs are connected to each other through one or several physical layer (PHY) interfaces, MTN.NE A sends an organizationally specific TLV of an LLDP message to MTN.NE B. The MTNS layer realizes the CV function and MTNS/FlexE interface distinguishing function by sending LLDP organizationally specific TLVs to each other.

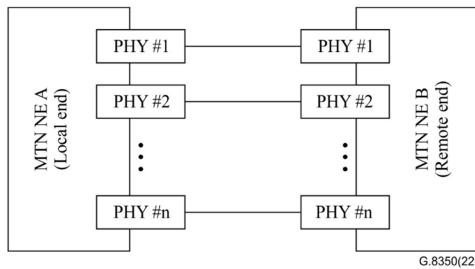

Figure A.1 – Two MTN.NEs exchange LLDP organizationally specific TLVs

The overall structure of an organizationally specific TLV is described in Figure 8-12 of [IEEE 802.1AB]. The LLDP protocol data unit (PDU) consists entirely of TLVs. All LLDP PDUs include three mandatory TLVs, 0 or more optional TLVs, and an end of PDU TLV. In the context of the MTNS layer, the organizationally specific TLVs listed in Table A.1 are required to be present in the 'optional TLVs' portion of the LLDP PDU, in the order shown.

Table A.1 – MTN organizationally specific TLVs

Organization-specific subtype	Purpose
0x01	MTNS connectivity verification
0x02	MTN capability
0x03	MTN working status

The organizationally unique identifier field of the TLV is set to the value assigned to ITU-T, 00-19-A7 (hex).

A.1 MTNS connectivity verification

The organizationally determined information string for the CV TLV contains a trail trace identifier (TTI) as specified in clause 9.1 of [ITU-T G.8312]. The insertion period of the MTNS TTI is specified in clause 7.1.1 of [ITU-T G.8321]. The structure of the MTNS CV TLV is shown in Figure A.2.

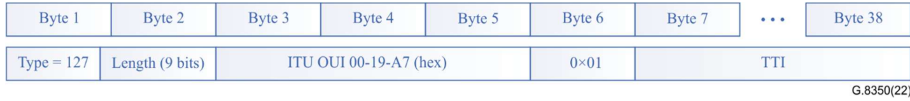

OUI: organizationally unique identifier

Figure A.2 – MTNS connectivity verification TLV structure

A.2 MTNS/FlexE interface distinction

A.2.1 MTN capability TLV structure

The structure of an MTN capability TLV is shown in Figure A.3.

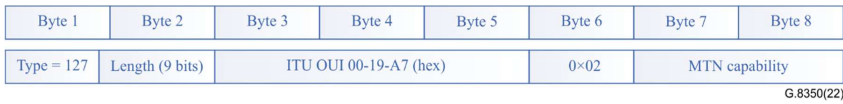

Figure A.3 – MTN capability TLV structure

The MTN capability field contains a bitmap indicating the working mode capability of a given local end PHY interface. Three capabilities are specified in a bitmap manner and illustrated in Table A.2. Each individual capability indicates that a given local end PHY interface can work in Standard Ethernet [IEEE 802.3] mode/MTN termination mode/FlexE termination mode.

Table A.2 – MTN capability field definition

Bit position	Function	Note
0	Standard Ethernet (IEEE 802.3) capability	Value 1: supported. Value 0: not supported.
1	MTN termination capability	Value 1: supported. Value 0: not supported.
2	FlexE termination capability	Value 1: supported. Value 0: not supported.
3~15	Reserved	All zeroes.

- Bit 0 indicates whether Standard Ethernet (IEEE 802.3) capability is supported.
- Bit 1 indicates whether MTN termination capability is supported.
- Bit 2 indicates whether FlexE termination capability is supported.

Any PHY interface of MTN.NE supports standard Ethernet capability, MTN termination capability and FlexE termination capability by default.

A.2.2 MTN working status TLV structure

The structure of an MTN working status TLV is shown in Figure A.4.

Byte 1	Byte 2	Byte 3	Byte 4	Byte 5	Byte 6	Byte 7	Byte 8
Type = 127	Length (9 bits)	ITU OUI 00-19-A7 (hex)			0×03	MTN working status	

G.8350(22)

Figure A.4 – MTN capability status TLV structure

The MTN working status field contains a bitmap indicating the current working mode of a given PHY interface in local end. The bitmap is illustrated in Table A.3.

Table A.3 – MTN working status field specification

Bit position	Function	Note
0	Standard Ethernet (IEEE 802.3)	Value 1: in use; value 0: not in use
1	MTN termination	Value 1: in use; value 0: not in use
2	FlexE termination	Value 1: in use; value 0: not in use
3~15	Reserved	All 0s

- Bit 0 indicates whether the PHY interface is in standard Ethernet working status.
- Bit 1 indicates whether the PHY interface is in MTN termination working status.
- Bit 2 indicates whether the PHY interface is in FlexE termination working status.

The MTN termination capability status has the highest rank. The FlexE termination working status is second in the ranking and the standard Ethernet working status has the lowest rank. In a normal condition, the MTN working status field has only one working status that is in use and the value of 1 is assigned to corresponding bit position. If multiple 1s are received in the MTN working status field, the highest rank working status with value 1 is considered to be the working status of the remote end PHY interface.

A.2.3 Link working status coordination between two adjacent MTN.NEs

The local end detects the remote end PHY interface capability and working status by receiving the MTN capability TLV and MTN working status TLV. Based on the capability information of the local end PHY interface and remote end PHY interface, the local end selects and configures an MTN working status for the local end PHY interface that is supported by both PHY interfaces and has the highest rank. Specifically, the working status selection is according to the following strategy.

- When the remote end PHY interface supports MTN termination capability, MTN.NE configures the local end PHY interface to the MTN termination working status.
- When the remote end PHY interface does not support MTN termination capability, but does support the FlexE termination mode, MTN.NE configures the local end PHY interface to the FlexE termination working status.
- When the remote end PHY interface only supports standard Ethernet capability, MTN.NE configures the local end PHY interface to the standard Ethernet working status.

If the remote end PHY interface works in the standard Ethernet mode and local end PHY interface works in MTN/FlexE mode, the local end cannot parse the LLDP organizationally specific TLV from the remote end PHY interface. The local end detects the remote end PHY interface working status by examining the anchor block (0x4B+0x5) of the incoming signal first. If an anchor block is detected, the local end learns that the remote end is in either MTN termination working status or FlexE termination working status. If the local end fails to detect an anchor block within a certain amount of time (e.g., 10 000 overhead frame cycles which is roughly 1 s) after powering up, it detects that the remote end PHY interface is in standard Ethernet mode and then also configures the local end PHY

interface to standard Ethernet working status. That local end PHY interface can then exchange an LLDP organizationally specific TLV with the remote end PHY interface.

After receiving the MTN capability TLV and MTN working status TLV from a remote end PHY interface, the local end PHY interface passes the corresponding TLV information to its management and control system. Optionally, based on the capability information of the local end PHY interface and remote end PHY interface, the management and control system can select an MTN working status that is supported by both PHY interfaces and has the highest rank. If the remote end PHY interface MTN capability TLV cannot be received by the local end PHY interface no matter what working status it is in, an MTN.NE should configure the local end PHY interface to standard Ethernet working status first and allow the management and control system to decide the subsequent working status configuration.

A.3 LLDP organizationally specific TLVs transmission channel

LLDP organizationally specific TLVs are transmitted through an MTNS management communication channel (MCC), when working status is MTN termination. As shown in Figure A.5, each LLDP MAC frame with LLDP organizationally specific TLVs is encoded into a sequence of 64B/66B blocks as specified in clauses 81 and 82.2.3 of [IEEE 802.3]. This sequence of blocks is transmitted through the MTNS MCC block by block, which is allocated on the seventh and eighth block of the MTNS overhead position. The MTNS sink termination function can extract the LLDP MAC frame block sequence from the section layer overhead; the LLDP MAC frame can then be extracted and corresponding information of the source end can be parsed.

The local end adjusts the LLDP organizationally specific TLV transmitting channel of the interface according to the working status of the remote end PHY interface:

- 1) if both the local end and remote end PHY interfaces are in a FlexE termination working status, LLDP organizationally specific TLVs are transmitted through the FlexE shim-to-shim management channel;
- 2) if both the local end and remote end PHY interfaces are in a standard Ethernet working status, LLDP organizationally specific TLVs are transmitted through an Ethernet link.

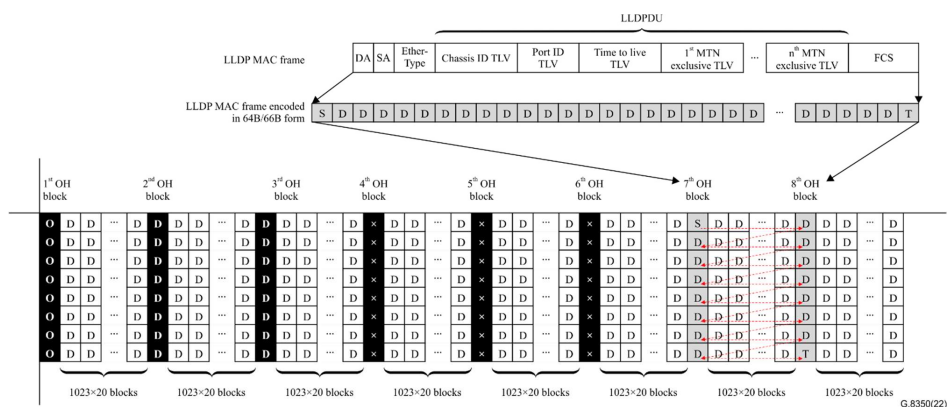

Figure A.5 – LLDP organizationally specific TLVs transmission channel over MTNS MCC

Annex B

MTN.NE automatic online management

(This annex forms an integral part of this Recommendation.)

Depending on the MTN.NE status and roles in the automatic online process, the NEs can be divided into two categories as follows.

- Wait-to-Online NE (W-NE): An NE that is not in service after deployment and can be discovered by the Neighbour Online NE.
- Neighbour Online NE (N-NE): An NE that has been in service and is adjacent to the Wait-to-Online NE.

The relationship between the Neighbour Online NE and the Wait-to-Online NE is dynamic and only valid when the NE goes online.

The general process for a W-NE to connect to the MC system automatically via N-NE and GNE is as follows.

- The W-NE sends a message to the N-NE through the MCC of the MTNS overhead frame (see clause 8.2.5.1 of [ITU-T G.7712]) when it needs to be online. The message includes DCN channel identification (DCN virtual local area network (VLAN)) and basic information for this W-NE. The basic information includes MAC, system name, system description, Internet protocol version 6 (IPv6) or Internet protocol version 4 address. The message is transmitted through MTNS overhead frame of MTN interface according to clause 9.2.4 of [ITU-T G.8312].
- The N-NE adds a new neighbour according to the message received from the W-NE and then reports the information for the W-NE to the MC system. The MC system can also obtain the W-NE information by querying the N-NE. After the MS system receives the message from the N-NE, which contains information about the N-NE and online information of the W-NE. The MC system can assign a management Internet protocol (IP) address for the W-NE to access DCN according to the geographical location of the N-NE.
- The W-NE receives a message from the MC system through the N-NE, and the message includes the management IP address assigned by the MC system for the W-NE. The W-NE can access the DCN based on this management IP address.

An example of an MTN network including a DCN is shown in Figure B.1. It is assumed that the GNE has been configured manually based on the planning and can establish the session connection with the MC system. NE1 and NE2 are already online and in service. The route between NE2 and the MC system is reachable. NE3 is a new MTN.NE and needs to access the DCN. During the process for the NE3 to connect to the MC system automatically, the NE3 plays the W-NE and the NE2 plays the N-NE; the detailed process is described as follows.

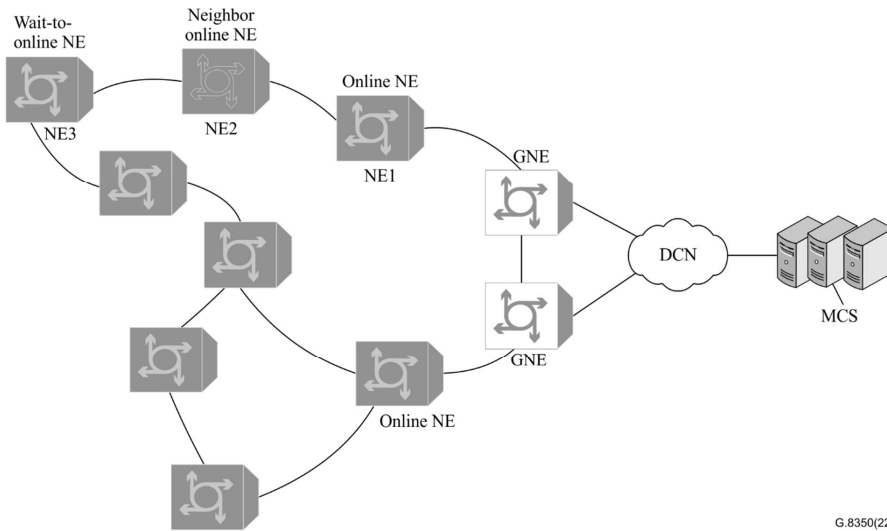

G.8350(22)

Figure B.1 – An example of an MTN network including a DCN

- 1) After the W-NE NE3 is powered on, the default IPv6 address for management is generated according to the MAC information of the NE, and the port generates the default VLAN identifier for the DCN, IPv6 link local address, and default open shortest path first version 3 (OSPFv3) configuration.
- 2) The W-NE NE3 interacts with the N-NE NE2 through the LLDP. The N-NE NE2 discovers the W-NE and reports the information about the W-NE to the MC system.
- 3) The MC system creates a new management object for this W-NE NE3 based on the received information. This could be performed after the modification of the IP address in (5).
- 4) The W-NE NE3 and N-NE NE2 interact with each other through the neighbour discovery protocol and update the routing table. The route between NE3 and NE2 is reachable.
- 5) Since the route between the W-NE NE3 and the MC system is still not reachable, the MC system can initiate the W-NE NE3 to modify the IPv6 address for management to be another planned address through secure-shell port forwarding.
- 6) After the W-NE NE3 modifies the IPv6 address for management, the OSPFv3 route is re-published.
- 7) The MC system establishes a connection with the W-NE NE3, and the state of the NE is online.

As specified in clause 8.2.5 of [ITU-T G.7712], MTNS overhead and MTN client can both be used for DCN transmission. This involves the method of switching between the two channels. At the beginning of the W-NE launches, because no MTN client has been configured, DCN message are transmitted through MTNS overhead. When the W-NE is in service, the MSC configures the MTN client, which can transmit DCN messages to the W-NE and receives the confirm message from the W-NE. The W-NE receives a command from the MSC and switches DCN transmission to the specific MTN client for which it can transmit the DCN based on the command. Furthermore, when the W-NE detects that a specific MTN client for the DCN is invalid or deleted, it can switch back to the MTNS overhead to transmit DCN messages.

Bibliography

- [b-Eclipse-Papyrus] Eclipse (2019). *Eclipse Papyrus™ modeling environment*. Brussels: Eclipse Foundation. Available [viewed 2023-05-27] at: <https://www.eclipse.org/papyrus/>
- [b-ONF TR-515] Technical Recommendation ONF TR-515 v1.3-info (2018), *Papyrus guidelines* Menlo Park, CA: Open Networking Foundation. 115 pp. Available [viewed 2023-05-27] at: https://www.opennetworking.org/wp-content/uploads/2018/08/TR-515_Papyrus_Guidelines_v1.3-1-1.pdf

SERIES OF ITU-T RECOMMENDATIONS

Series A	Organization of the work of ITU-T
Series D	Tariff and accounting principles and international telecommunication/ICT economic and policy issues
Series E	Overall network operation, telephone service, service operation and human factors
Series F	Non-telephone telecommunication services
Series G	Transmission systems and media, digital systems and networks
Series H	Audiovisual and multimedia systems
Series I	Integrated services digital network
Series J	Cable networks and transmission of television, sound programme and other multimedia signals
Series K	Protection against interference
Series L	Environment and ICTs, climate change, e-waste, energy efficiency; construction, installation and protection of cables and other elements of outside plant
Series M	Telecommunication management, including TMN and network maintenance
Series N	Maintenance: international sound programme and television transmission circuits
Series O	Specifications of measuring equipment
Series P	Telephone transmission quality, telephone installations, local line networks
Series Q	Switching and signalling, and associated measurements and tests
Series R	Telegraph transmission
Series S	Telegraph services terminal equipment
Series T	Terminals for telematic services
Series U	Telegraph switching
Series V	Data communication over the telephone network
Series X	Data networks, open system communications and security
Series Y	Global information infrastructure, Internet protocol aspects, next-generation networks, Internet of Things and smart cities
Series Z	Languages and general software aspects for telecommunication systems