

# Making BGP filtering a habit: Impact on policies

JuanCamilo.Cardona@imdea.org

Pierre.Francois@imdea.org

IMDEA Networks

[draft-cardona-filtering-threats-02](#)

# Diffs from last version

- Editorial changes
- Removed all terms referring to Policy violation, threats, etc.
- Introducing Undesired Flows
  - Traffic between BGP peers for which the operator does not want to server as transit.

# Undesired Flows

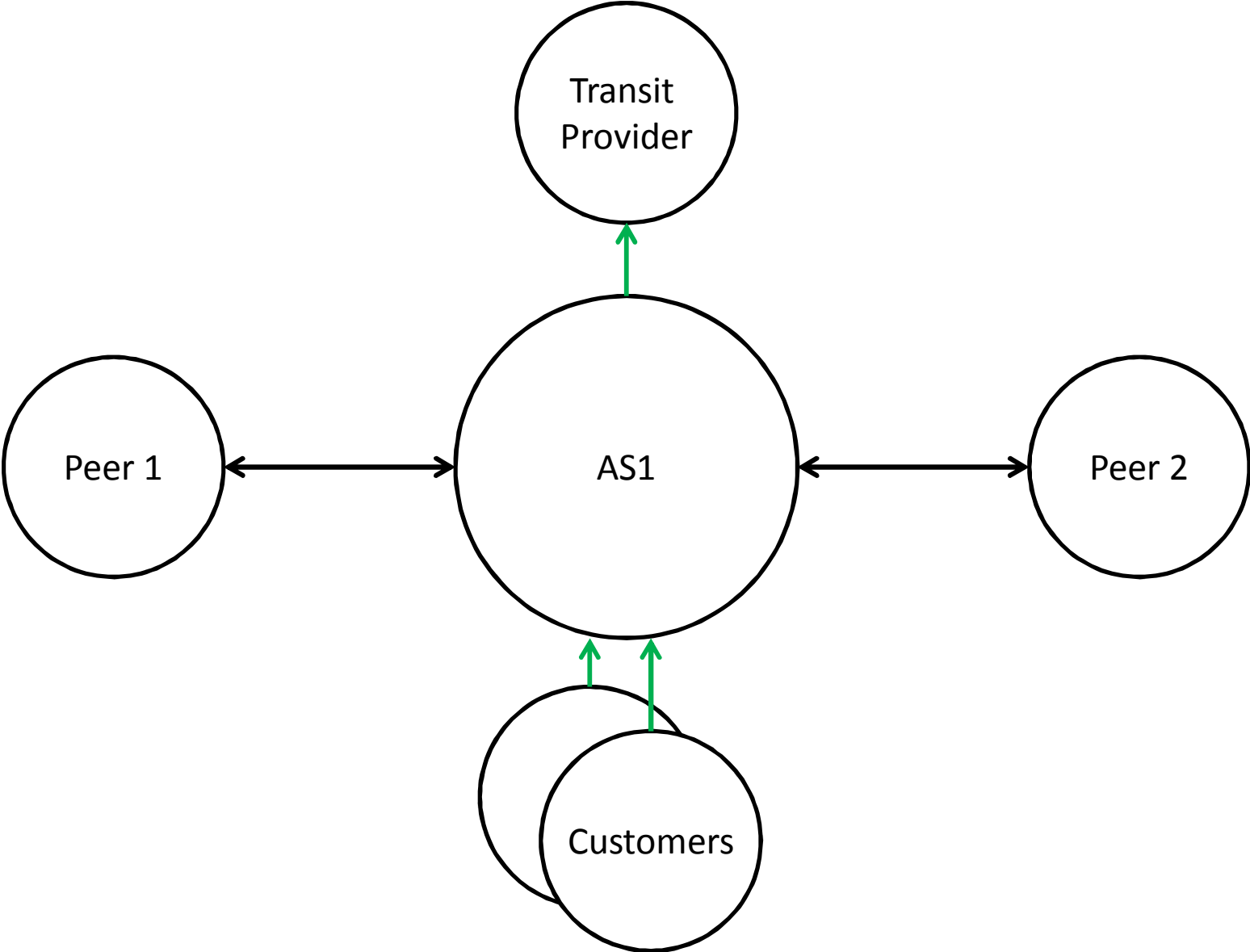

# Undesired Flows

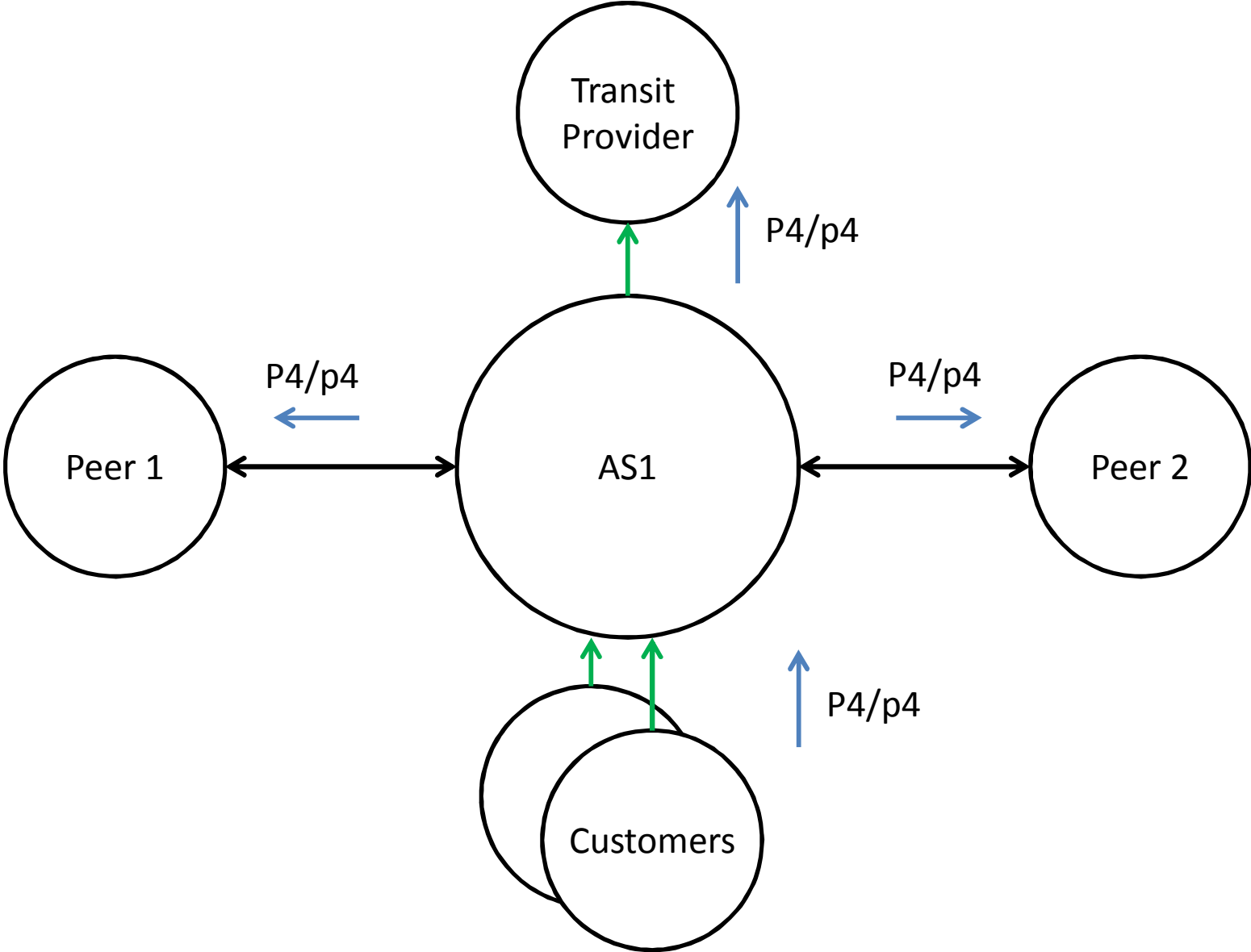

# Undesired Flows

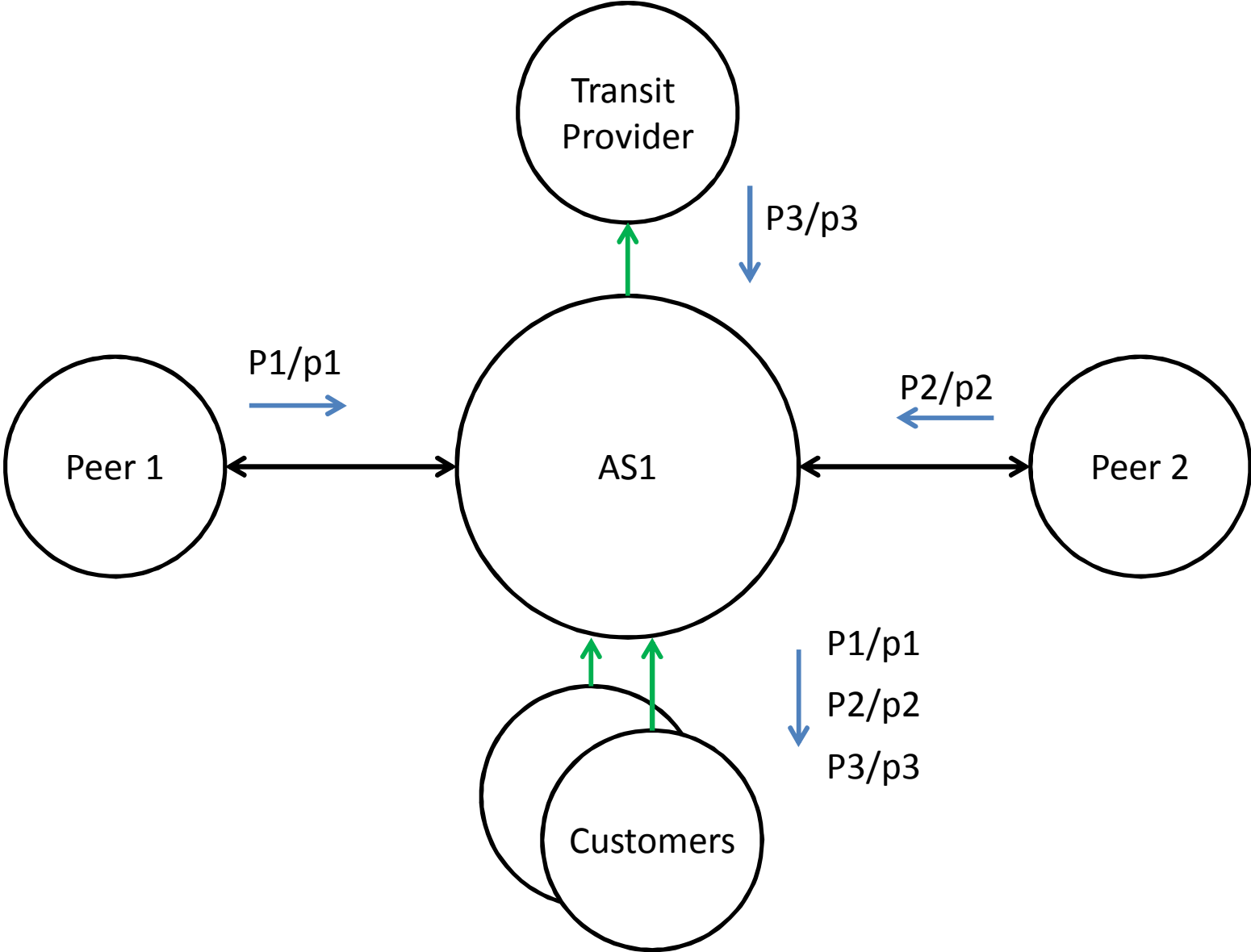

# Undesired Flows

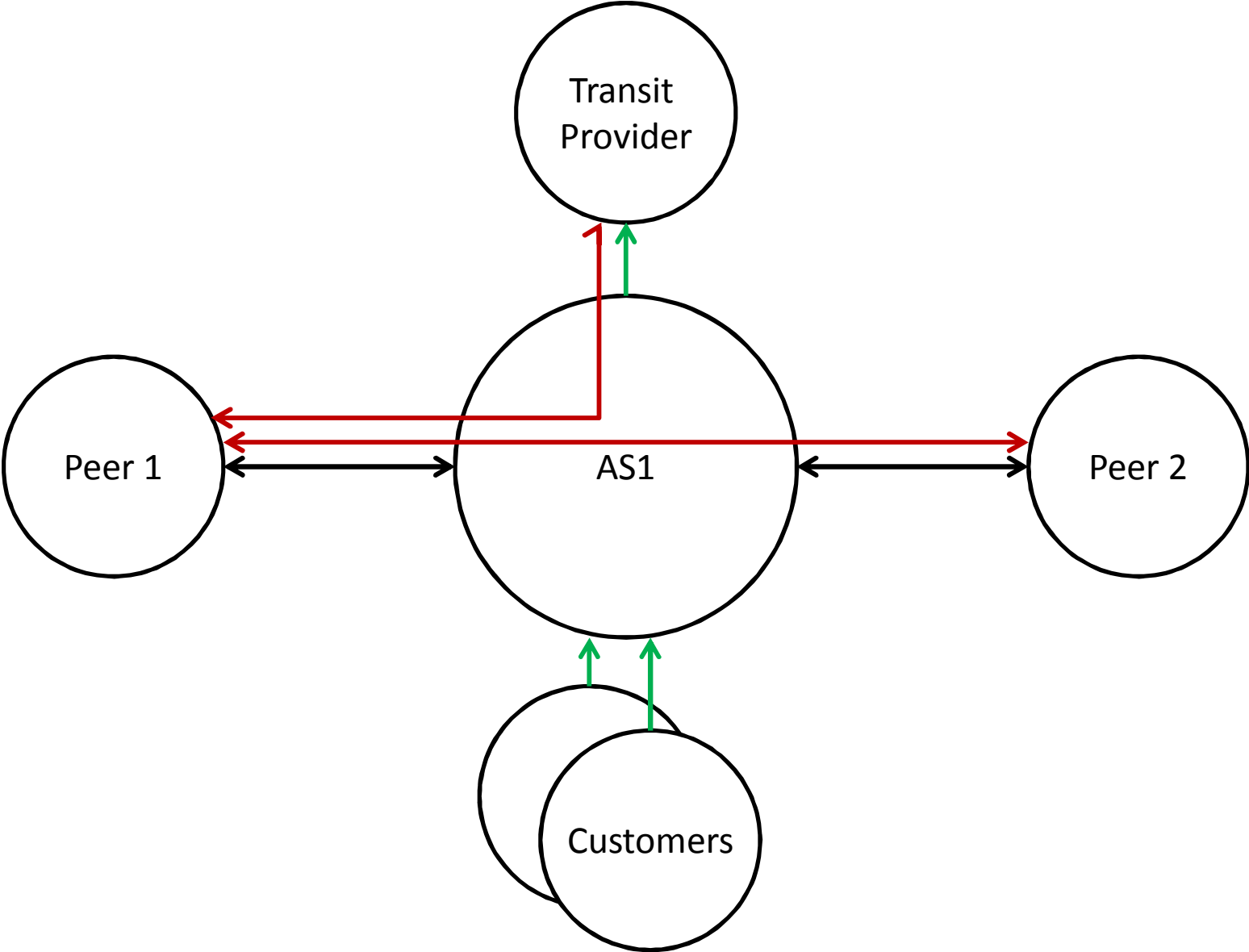

# Local filtering

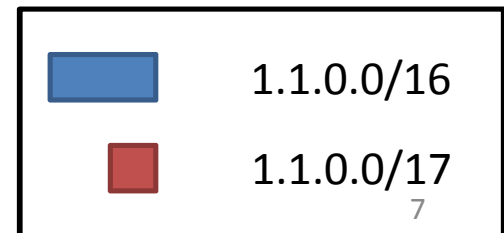
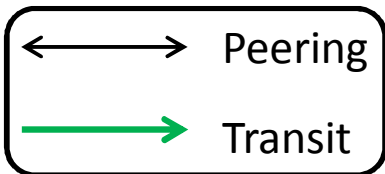
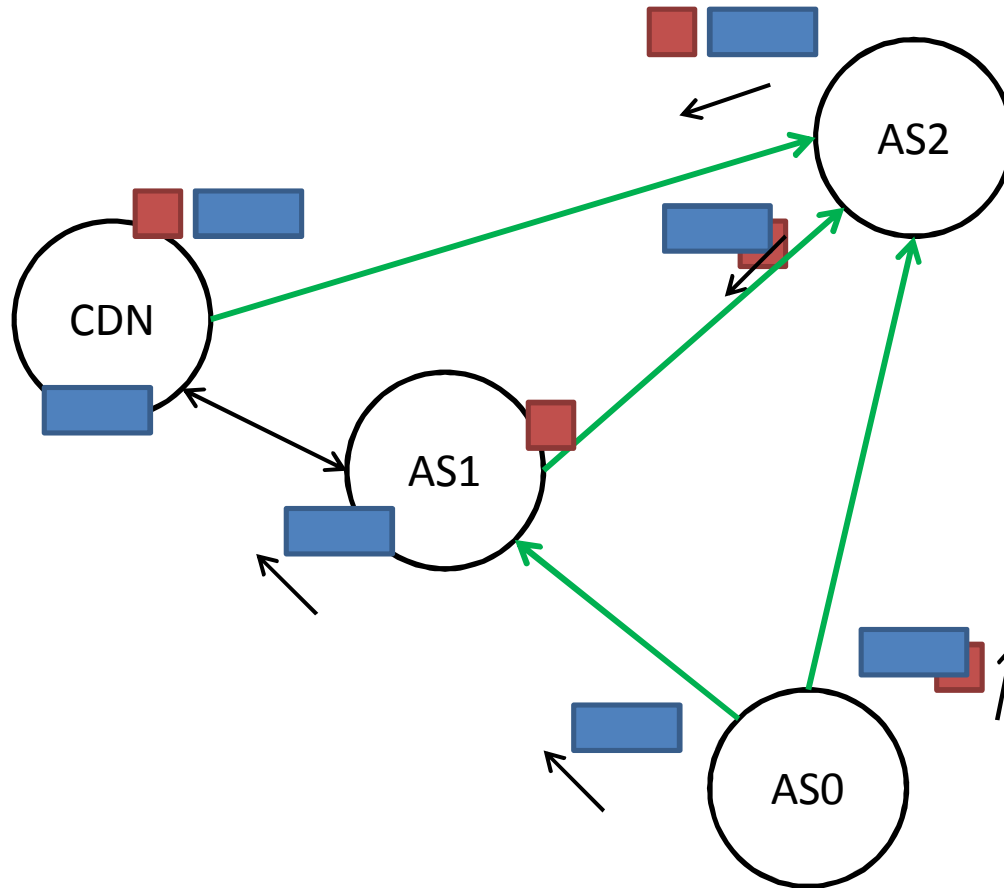

# Local filtering

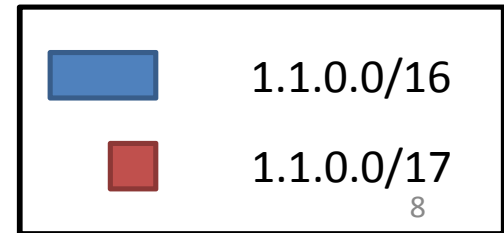
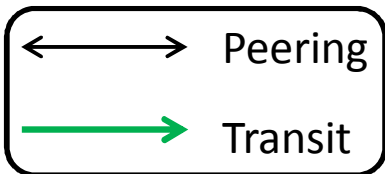
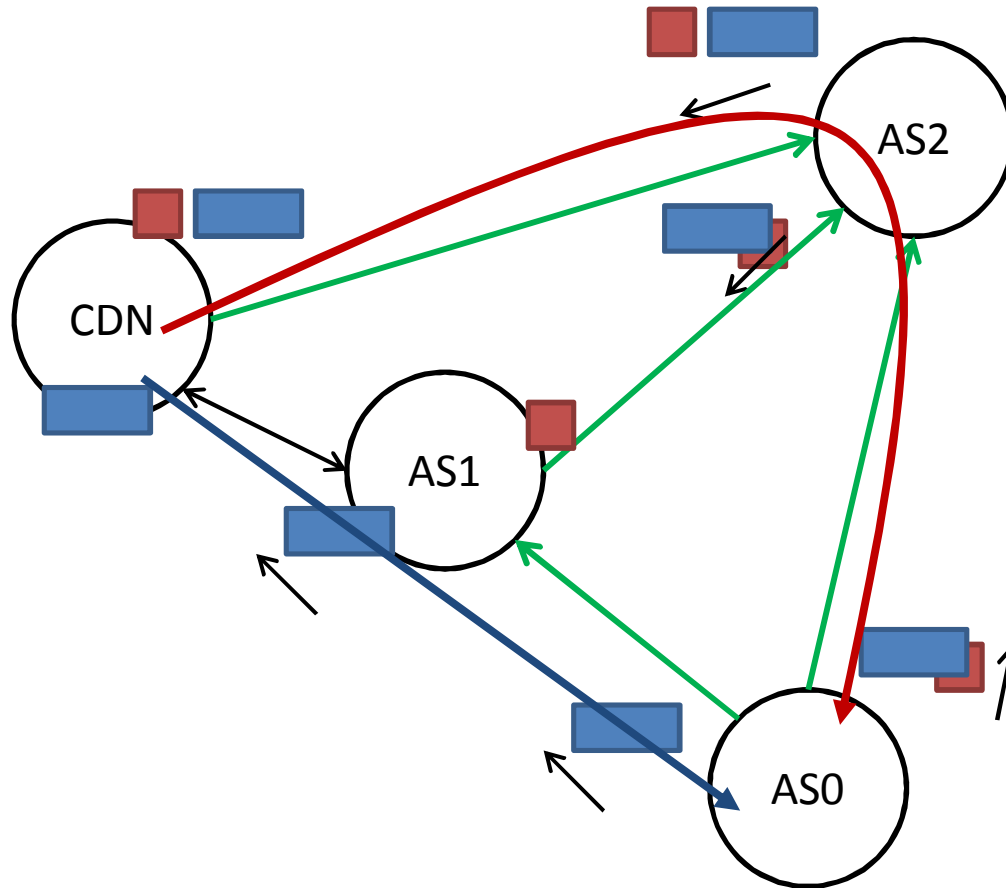



# Local filtering

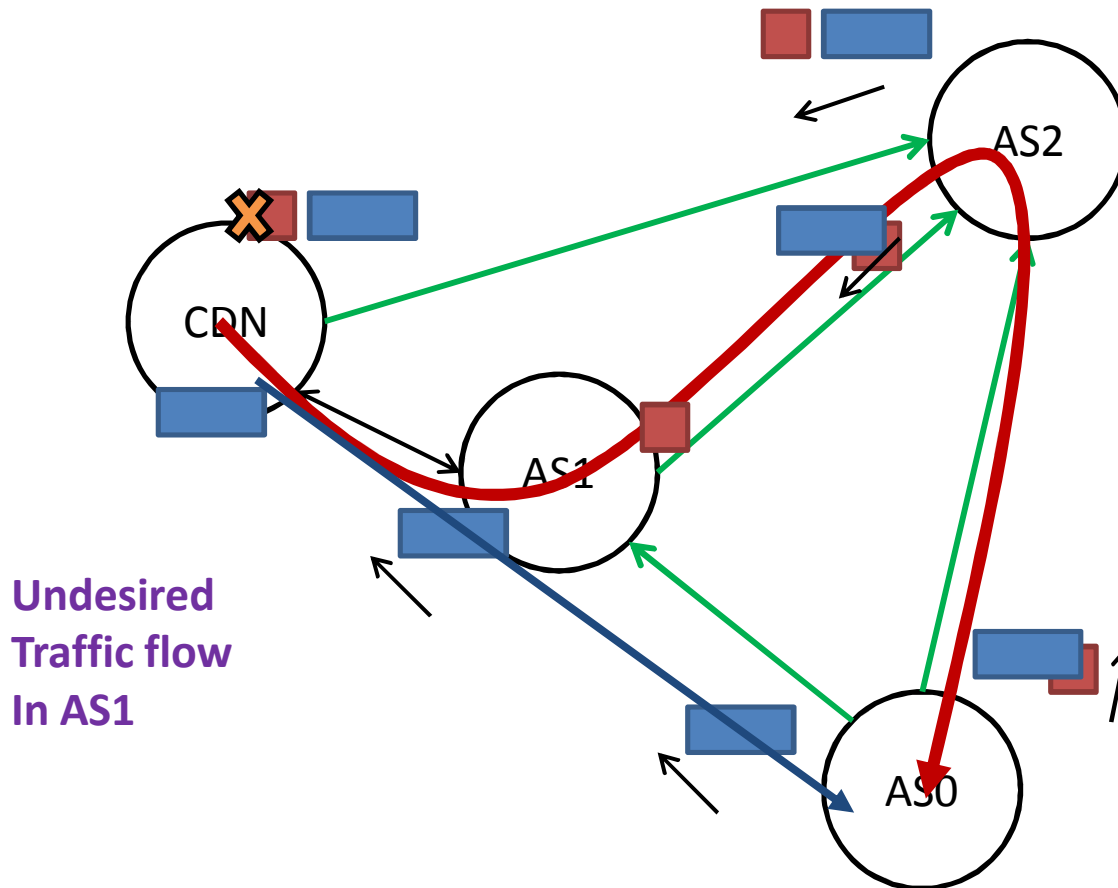

Undesired  
Traffic flow  
In AS1

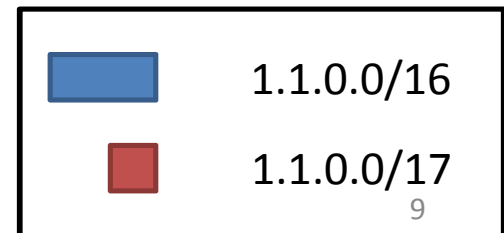
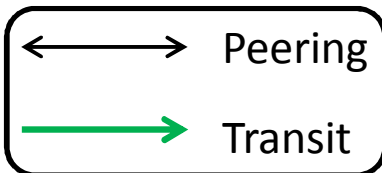

# Next steps

- Consider feedback
- WG DOC?