

88th IETF @ Vancouver

Central Controlled IPRAN

draft-khy-rtgwg-central-controlled-ipran-00.txt

Katherine Zhao(Katherine.Zhao@huawei.com)

GuangMing Yong (yanggm@gsta.com)

Jiehui Hu (hujiehui@huawei.com)

Introduction

- **IP RAN (Radio Access Network) is a run solution using IP technology to provide network services between UE devices and mobile core network.**
- **IP RAN has been widely used to provide varies access modes with high scalability and flexibility, it reduced network construction cost and protects codes of investments.**
- **However the existing IP RAN implementation needs to be improved due to**
 - **Manual configuration Point-by-Point**
 - **Complex network construct and service deployment**
 - **Low troubleshooting efficiency**
- **Central Controlled IP RAN (SDN enabled) can further improve the IP RAN and resolve these problems**

Central Controlled IP RAN Use Case

Applied in China Telecom's Access and Aggregation Network

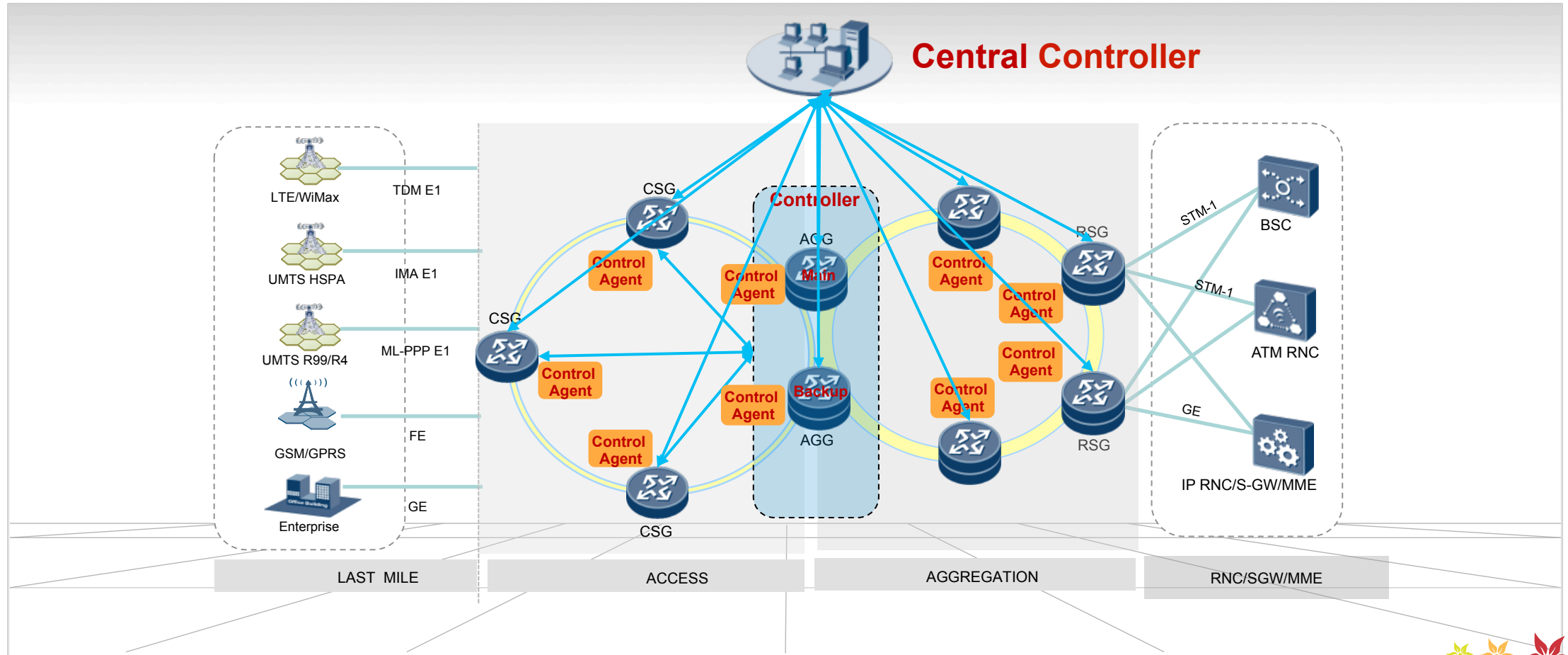

CC IP RAN Network Architecture

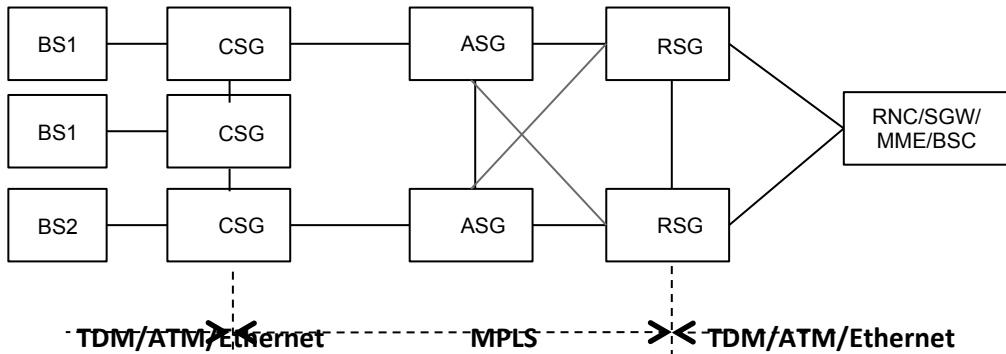

Conversational IP RAN Network

- ASG: Aggregation Service Gateway
- BS: Base Station
- CSG: Cell Site Gateway
- RSG: Radio Service Gateway

- Major Control functions are moved to controller from network devices
- Controller has E2E control capability
- Access, Aggregation and RSG are forwarding devices.
- Programmability of controller
- Open to third party applications

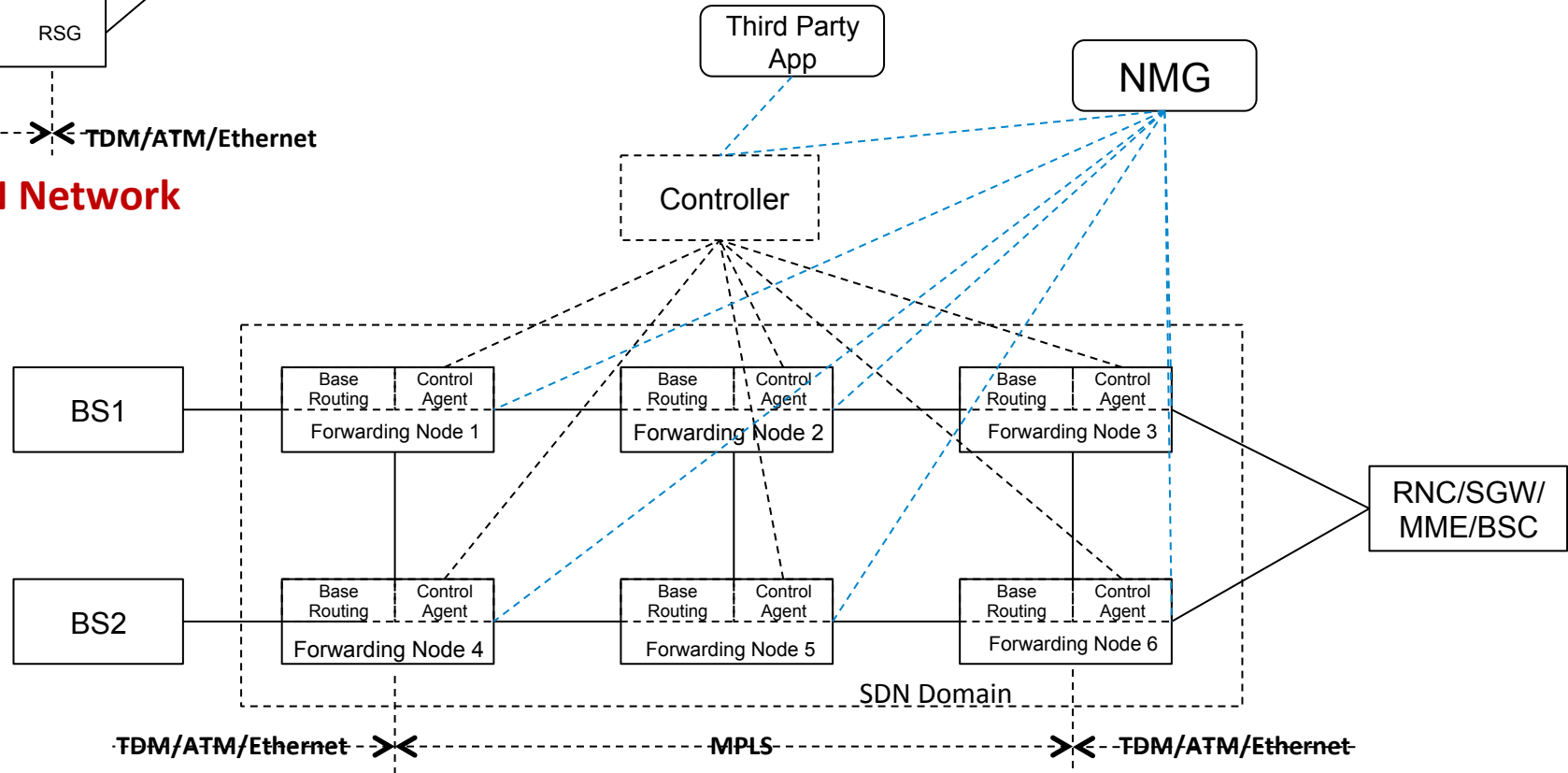

Central Controlled IP RAN Network

System Architecture

- **Functions of Controller**

- CP-DP control protocol features
- Network resource management features
- Network virtualization features
- Network protocol layer, IGP, LDP/RSVP
- Network service layer, L2 (VPWS/VPLS) VPN, L3 VPN
- Fault, Alarm, NB-API

- **Functions of Forwarding Node**

- IP/ MPLS forwarding
- CP-DP protocol features
- Control Agent
- Light IGP for connectivity

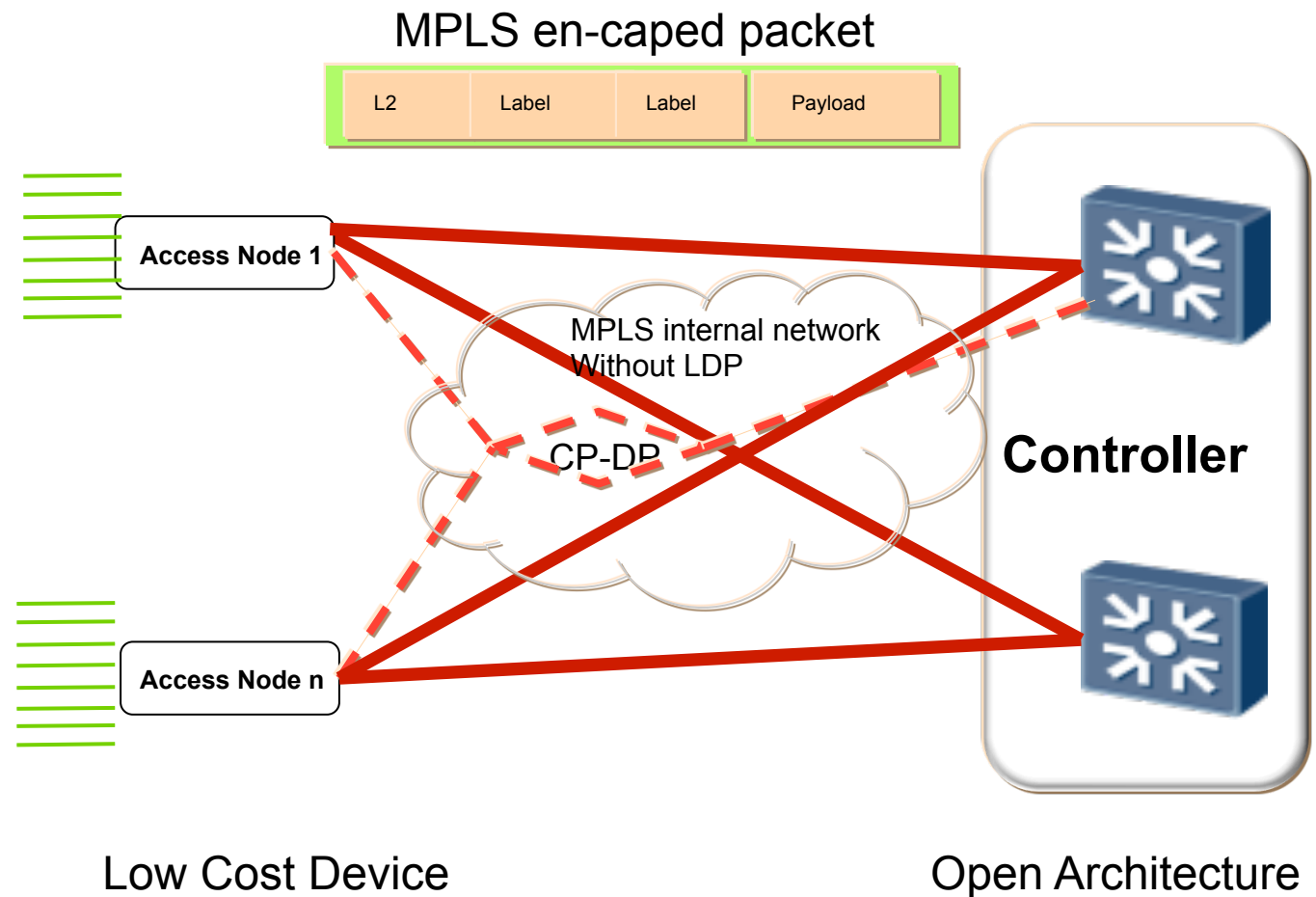

Controller Deployment Options

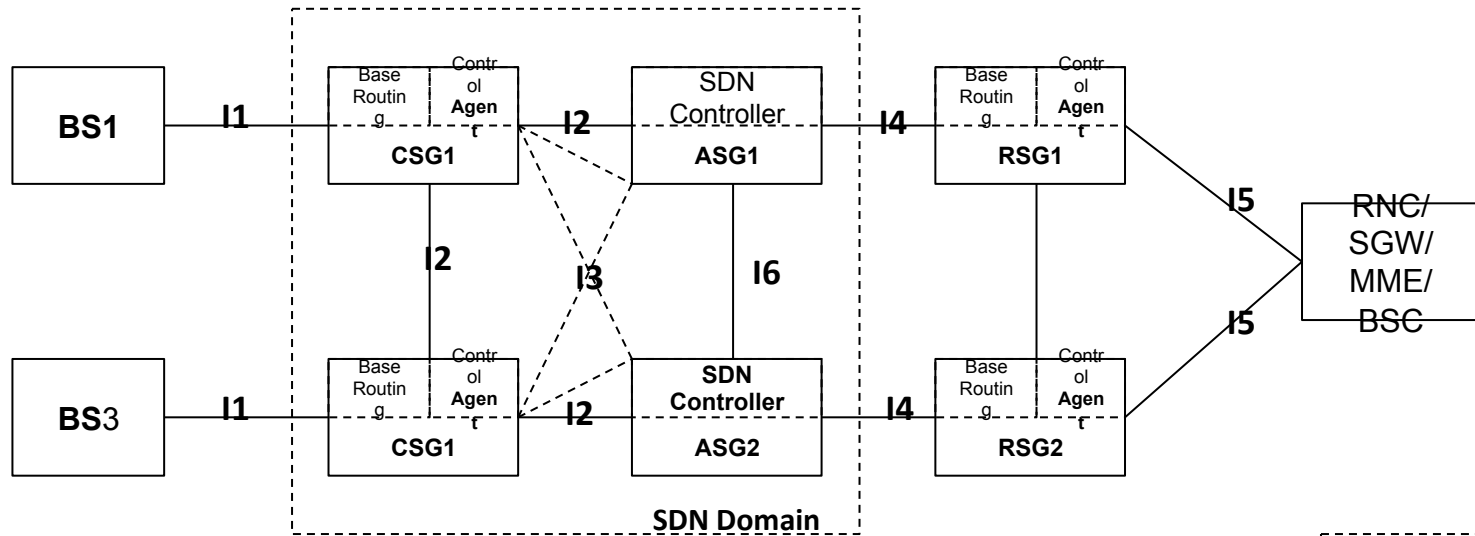

**Built-in Mode:
Controller on Device**

**Stand-alone Mode:
Controller on Server**

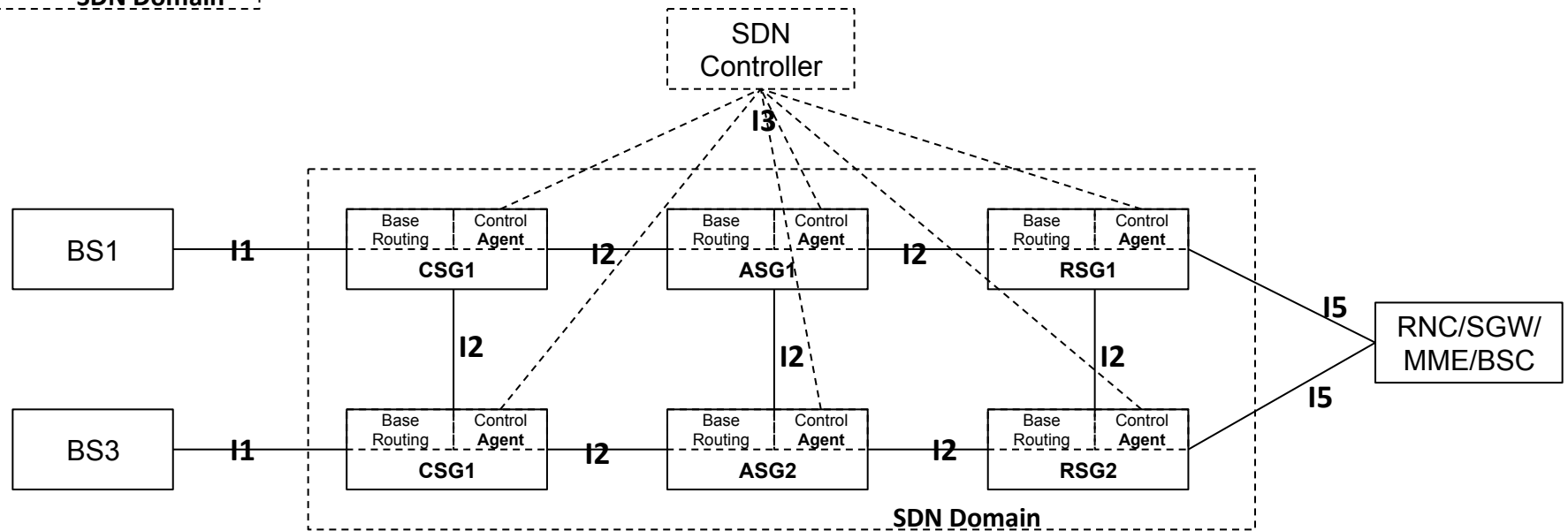

Central Controlled IP RAN Overview

Mobile Backhaul

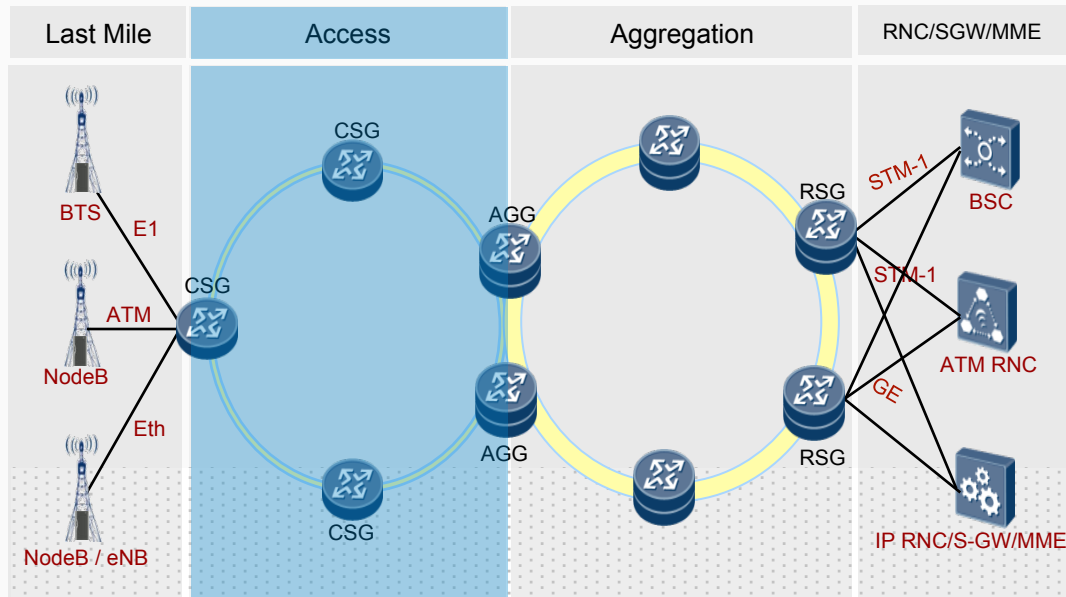

Manual configuration point-by-point

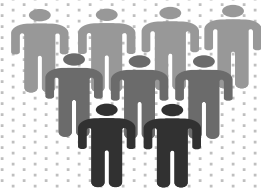

Central Controlled IP RAN

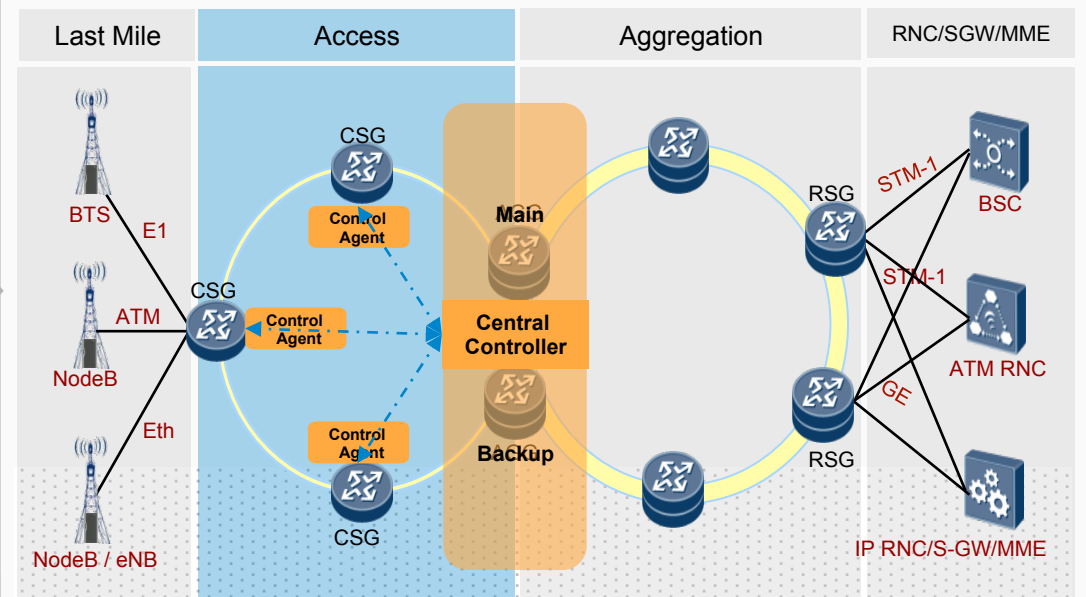

Simple O&M



- Free Service Planning, Plug and Play
- Automatic protocols deployment and fast services launch
- Fast trouble shooting



Free Service Planning, Plug and Play

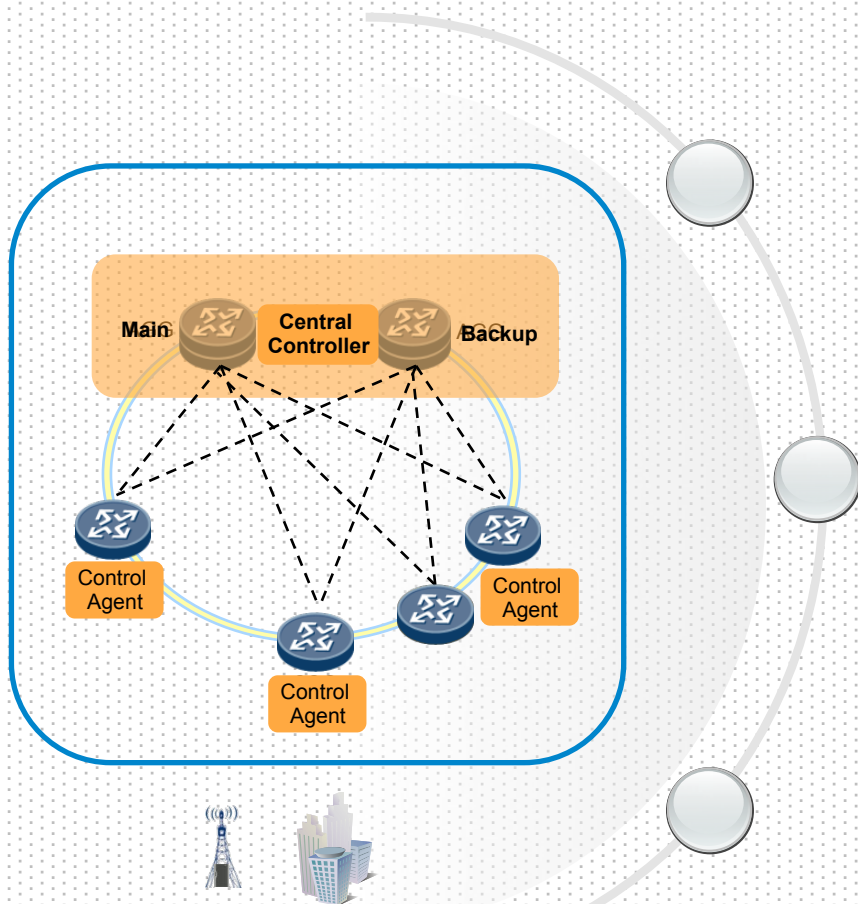

Mobile Backhaul : Complex services planning

Planning IP Address 	Dividing IGP Area 	Planning CSG&AGG ring relations
-------------------------	-----------------------	-------------------------------------

SDN-based Mobile Backhaul : Free Services Planning

Planning IP Address 	Dividing IGP Area 	Planning CSG&AGG ring relations
--------------------------------------	------------------------------------	--

Saving

Plug and Play, Zero Touch for Basic Network

Solution	Current IP RAN Access Solution	Central Controlled IP RAN
IGP	Yes	Automatic deployment
RSVP-TE	Yes	No

Automatic Protocols Deployment and Fast Services Launch

Mobile Backhaul

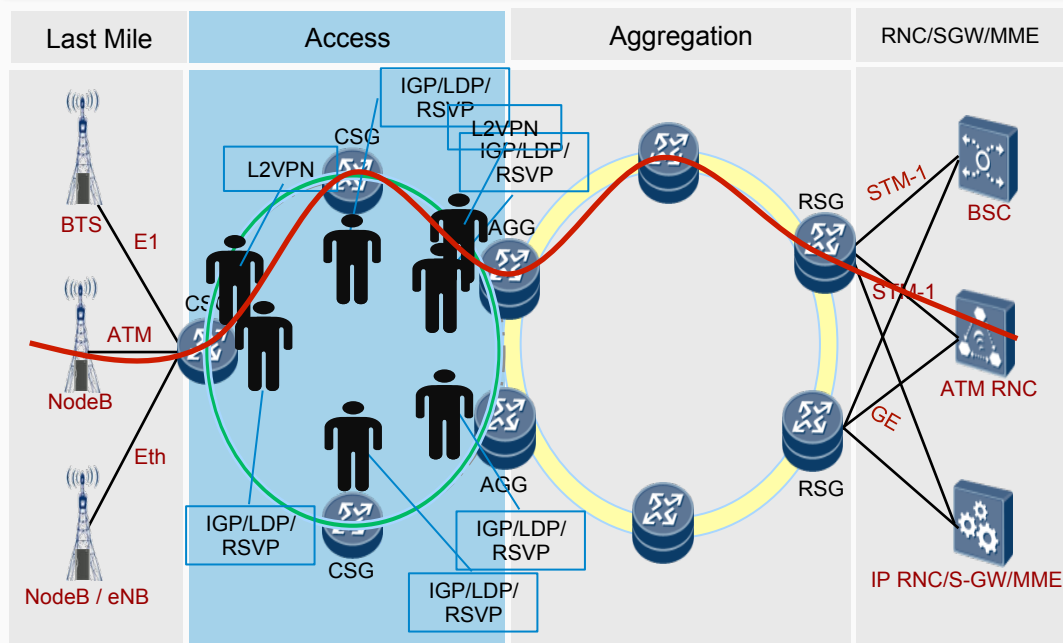

Protocol-based point-by-point services launch

Central Controlled IP RAN

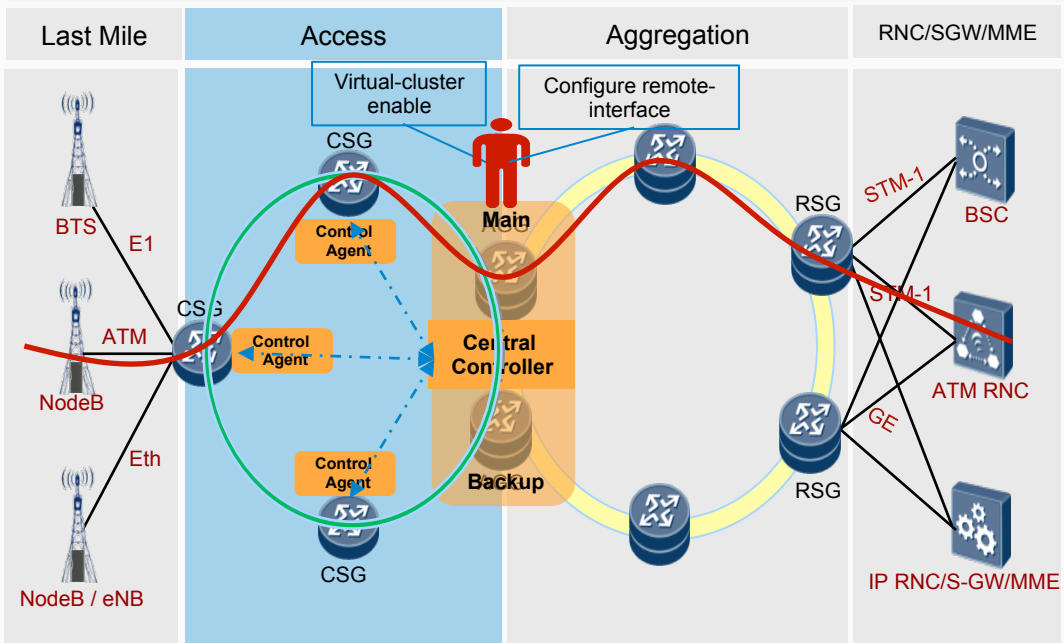

Service-based end-to-end services launch

Simple protocol
Automatic configuration

Lowers skill
requirements of staff

Improves efficiency of
services launch

Fast Trouble shooting

Mobile Backhaul

① Each node sends alarm independently

② Trouble shooting on each node

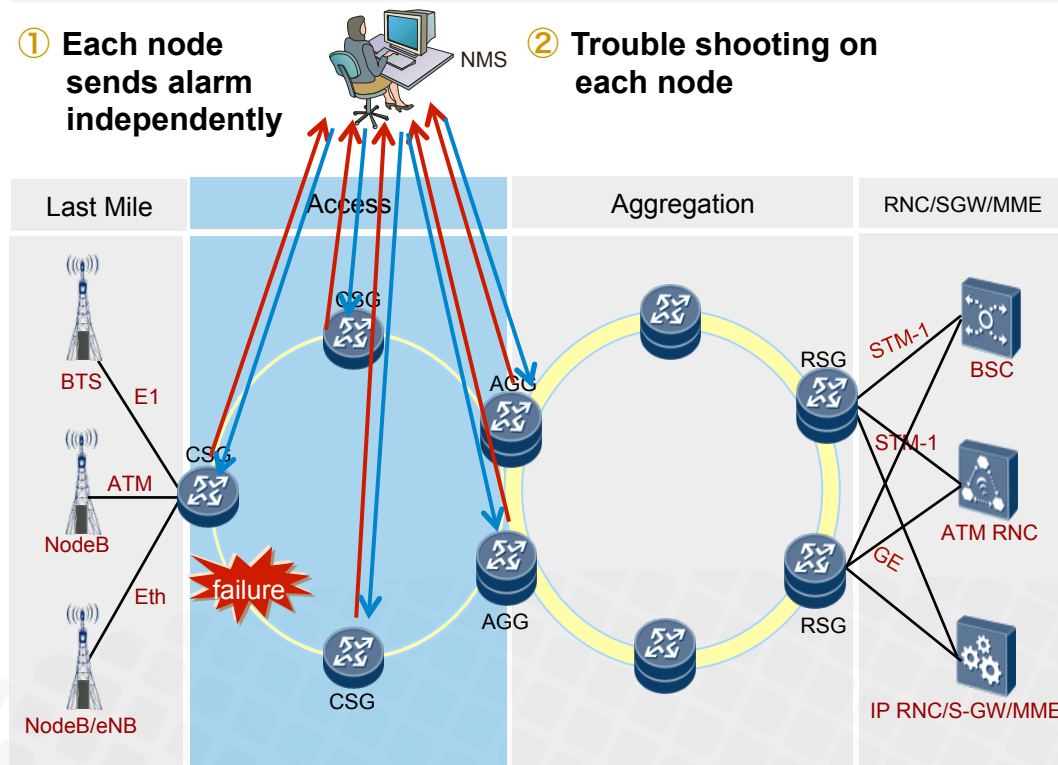

SDN-based Mobile Backhaul

① Alarm analysis for Locating root causes of fault

② Trouble shooting only on Central Controller

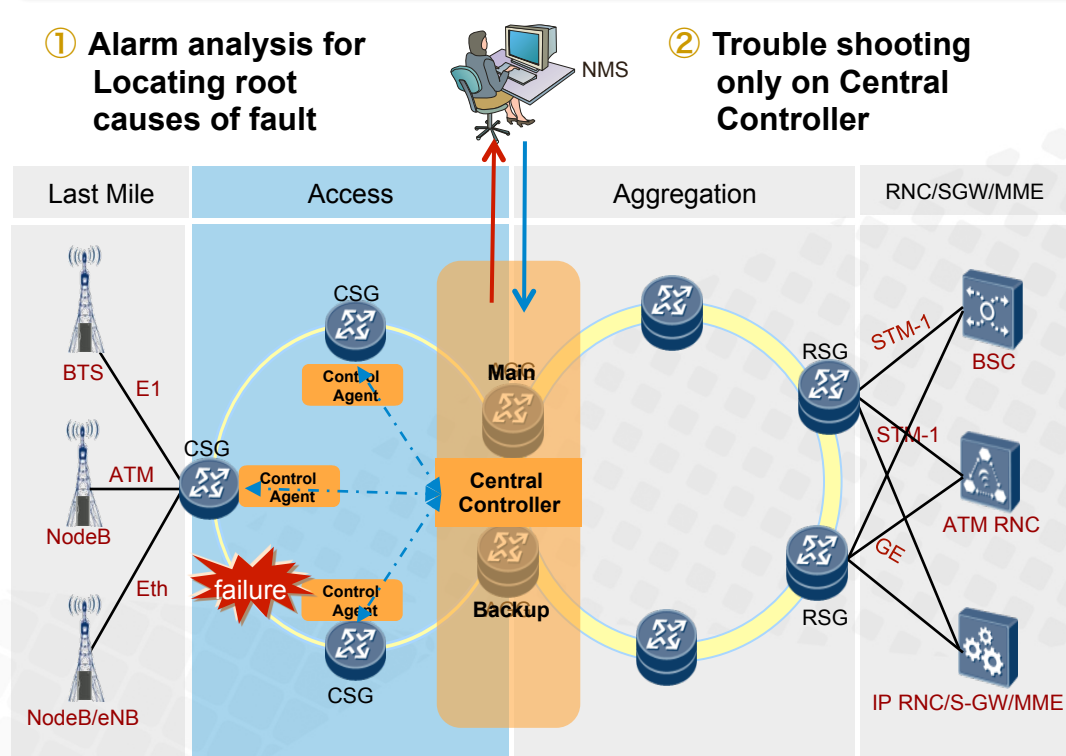

Thank you

www.huawei.com

Copyright©2013 Huawei Technologies Co., Ltd. All Rights Reserved.

The information in this document may contain predictive statements including, without limitation, statements regarding the future financial and operating results, future product portfolio, new technology, etc. There are a number of factors that could cause actual results and developments to differ materially from those expressed or implied in the predictive statements. Therefore, such information is provided for reference purpose only and constitutes neither an offer nor an acceptance. Huawei may change the information at any time without notice.