

IS-IS Extensions for MPLS Multi-Topology

draft-li-isis-mpls-multi-topology-00

Zhenbin Li, Quintin Zhao
Huawei Technologies

IETF 89, London, United Kingdom

Requirement on Virtual Network(1)

- As the virtual network operators develop, it is desirable to provide better network virtualization solutions to facilitate the service.
- [I-D.li-mpls-network-virtualization-framework] introduces a new framework to implement network virtualization based on MPLS global label.

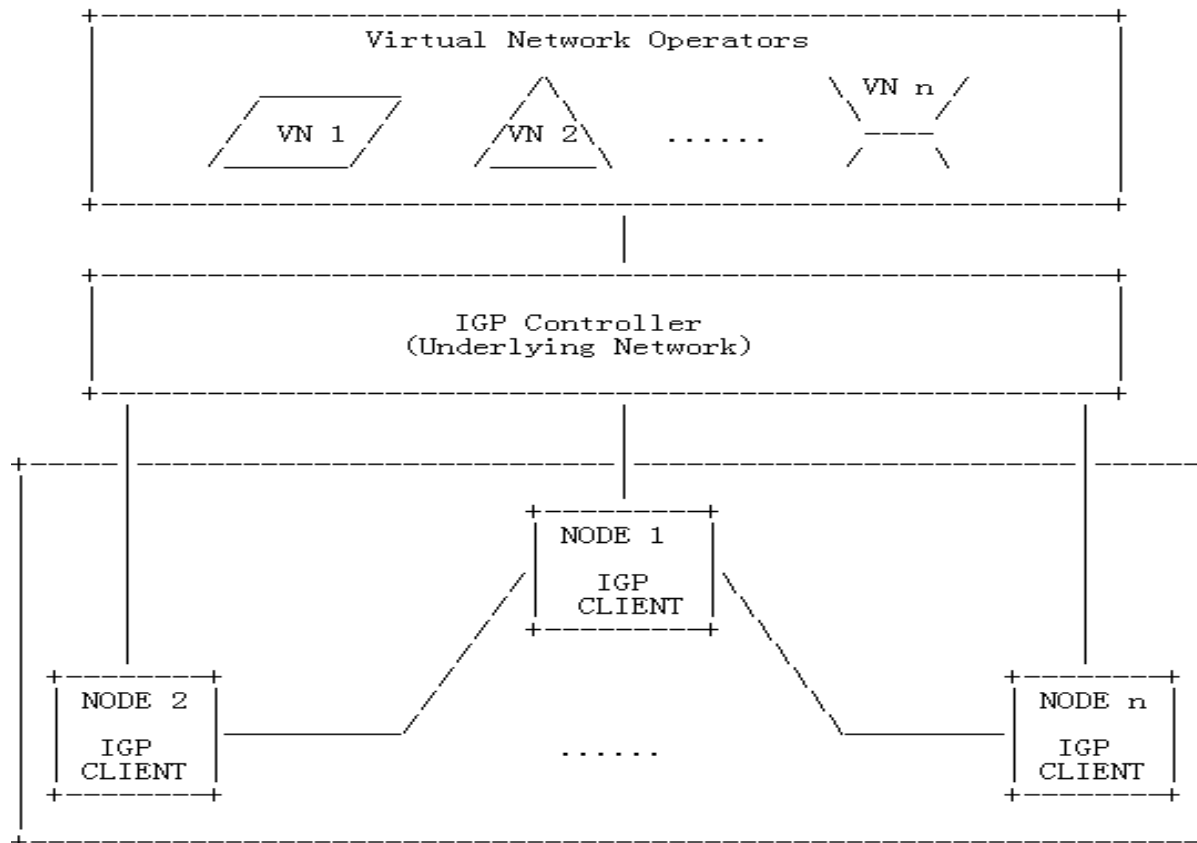

Requirement on Virtual Network(2)

- MRT FRR based on MPLS Multi-Topology
 - Issues for IP FRR: No fields in IP header to identify Virtual Network (IGP Multi-Topology). DSCP is not a good choice for IGP multi-topology.
 - LDP Multi-topology for IP FRR: MPLS label is used to identify prefixes in multiple topologies. MPLS encapsulation helps extend IP header.
 - MPLS Global Label for IP FRR: For pure-IP network, it just needs to extend IP header to identify multi-topology. MPLS global label is to represent different multi-topology globally. Comparing with LDP MT it can only use IGP and save labels, but needs to update forwarding plane for all nodes.

MRT based on MPLS MT

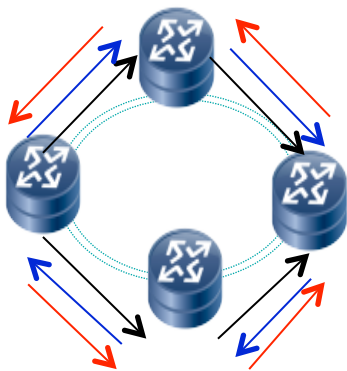

Compute three topologies: SPF, MRT-Red, MRT-Blue

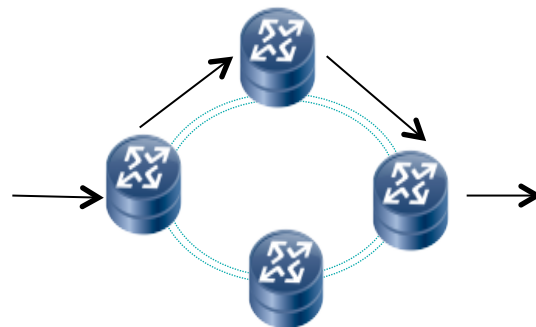

Traffic forwarded by SPF.

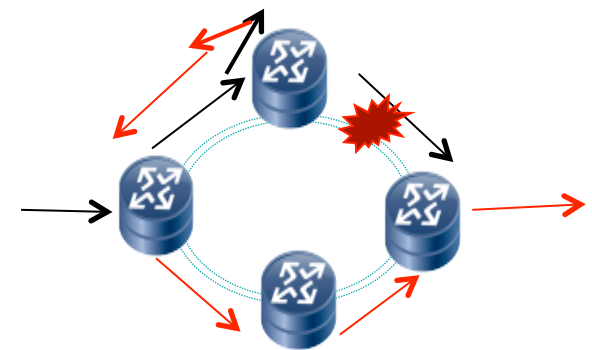

Traffic forwarded by MRT-Red when fault happened.

IGP Extensions for MPLS Global Label

- As described in [I-D.li-mpls-global-label-usecases] and [I-D.li-mpls-global-label-framework], different protocol extensions (IGP, BGP, PCE) are suitable for different application scenarios.
- As described in above requirements on virtual network, all nodes should learn the label to represent specific multi-topology.
- IGP is a natural choice to flood the label binding information to network nodes.

Choice of IGP Extensions for Label Allocation

- Segment vs. Label
 - Is IGP extensions for segment routing independent from IGP extensions for label allocations?: Segments can map to IPv6 and MPLS.
 - IGP extensions for label allocation should decouple from segment routing: It should not only be used for segment routing.
- Distributed vs. Central Control
 - Reserved SRGB + Global Segment Index in Segment routing: How to reserve SRGB to cope with future development of segment routing?
 - Central Controlled label allocation is a natural choice to coordinate label allocation for all network nodes.
- Independent label TLV vs. Extended link-state TLV
 - IGP-based label allocation will break through the traditional IGP usage: label allocation for multi-topology.
 - Label allocation should not be confined to the existing framework for link state.
 - For label allocation, IGP should consider as MPLS protocol instead of link-state routing protocol.

IS-IS Extensions for MPLS Multi-topology(1)

- IS-IS Label Mapping TLV

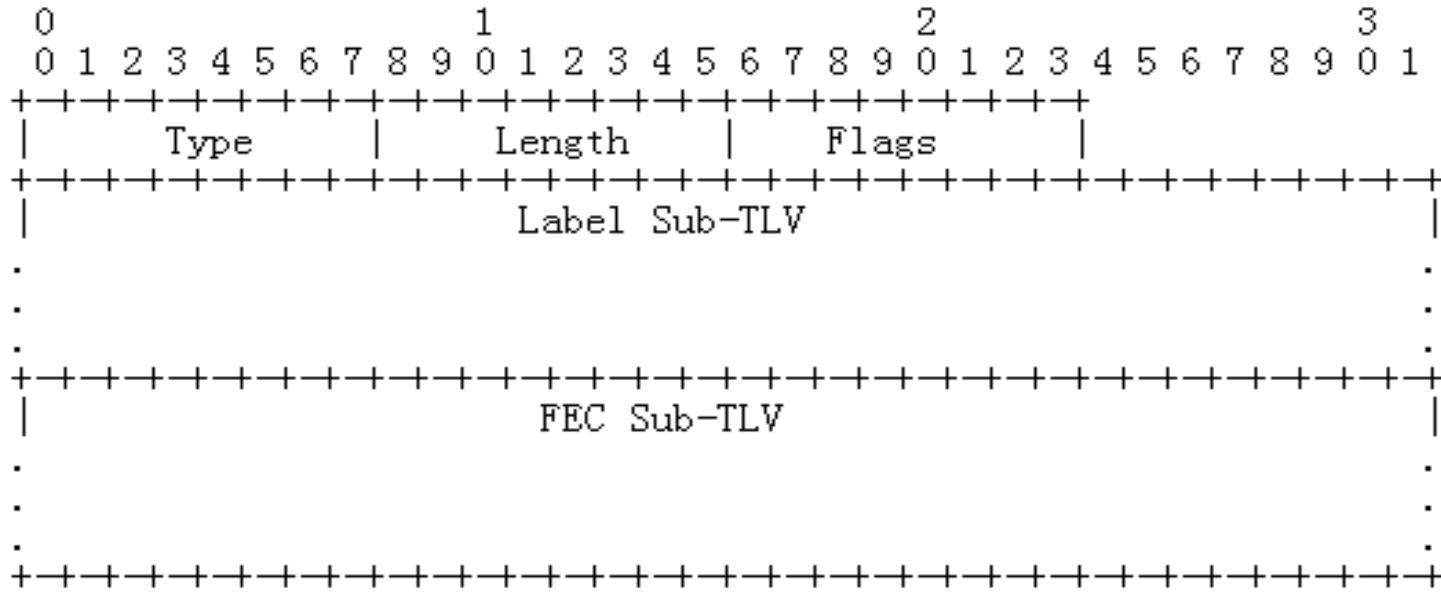

Figure 1: IS-IS Label Mapping TLV format

IS-IS Extensions for MPLS Multi-topology(2)

- Label Sub-TLV

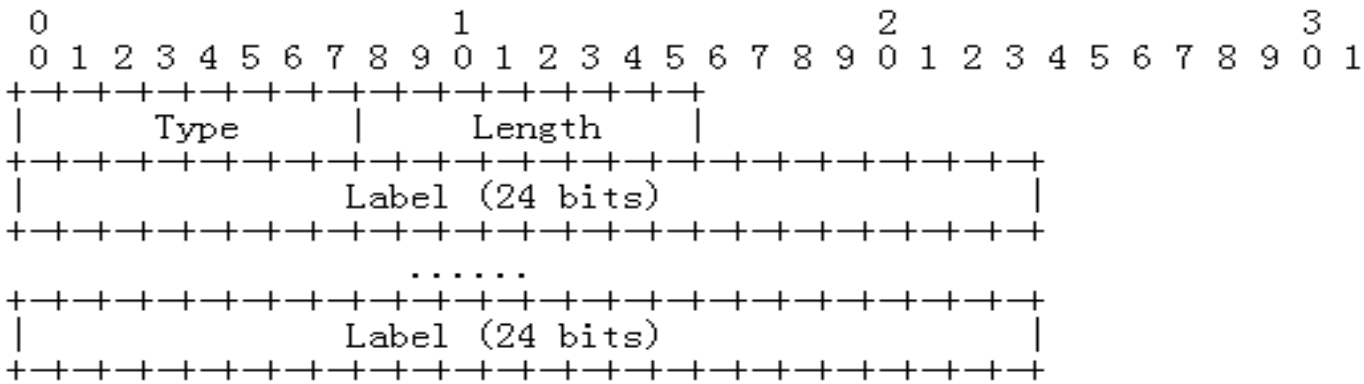

Figure 2: Label Sub-TLV Format

- MPLS Multi-topology Sub-TLV (Example of FEC sub-TLV)

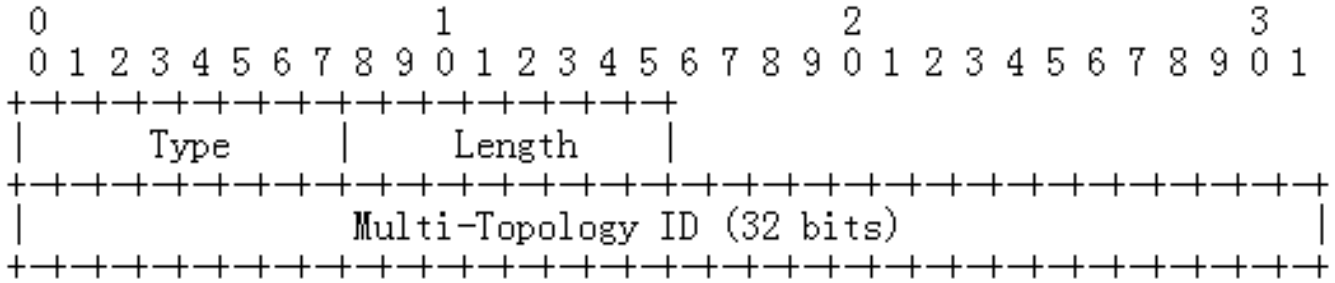

Figure 3: Multi-Topology Sub-TLV format

Next Steps

- Discuss on choice of IGP extensions for label/segment allocation.
- Revise the draft to improve IS-IS extensions for MPLS multi-topology.