

Seamless MPLS for Mobile Backhaul

draft-li-mpls-seamless-mpls-mbh-00

Zhenbin Li, Lei Li (Huawei)
Manuel Julián López Morillo (Vodafone)
Tianle Yang (China Mobile)
Luis M. Contreras (Telefonica I+D)

IETF 90, Toronto, Canada

Updates

- Change the draft name from draft-li-mpls-seamless-mpls-**mbb**-00 to draft-li-mpls-seamless-mpls-**mbh**-00
- Add one co-author: Luis from Telefonica I+D
- Remove the solutions for seamless MPLS for mobile backhaul network. Please refer to the related solutions drafts.
- Add detailed problem statement and define corresponding requirements.
- Correct text errors.

Seamless MPLS Network Architecture

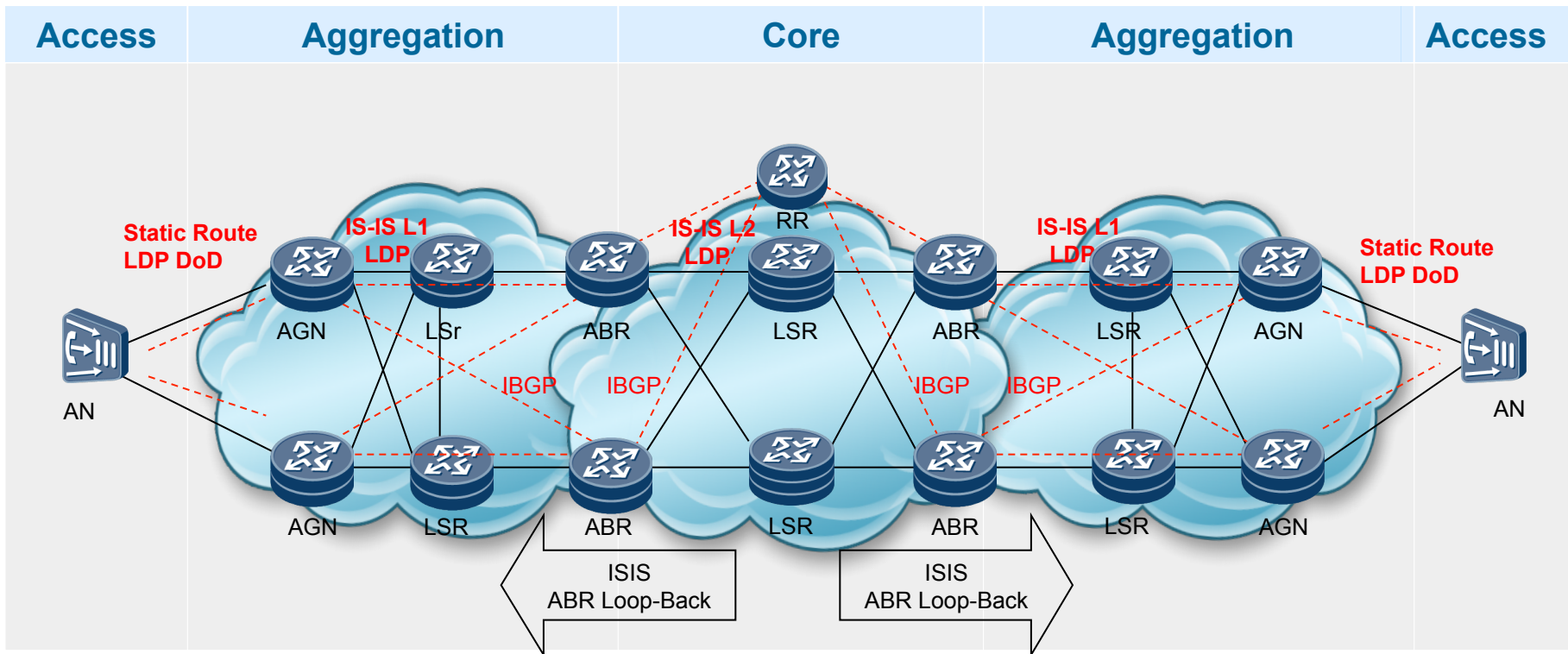

- The key concepts for Seamless MPLS: Decoupling the transport layer and service layer.
- The network will be divided into multiple IGP areas for access, aggregation and core network
- IBGP run among the Area Border Routers (ABRs) to advertise labeled route.
- LDP DoD is introduced to set up LSP on demand between AN and AGN.

Seamless MPLS for Mobile Backhaul Networks

- Ring topology is adopted in mobile backhaul networks.
- Variable devices with variable capability are deployed in the access ring and aggregation ring.
- L3VPN and TE propose new requirements on Seamless MPLS architecture.

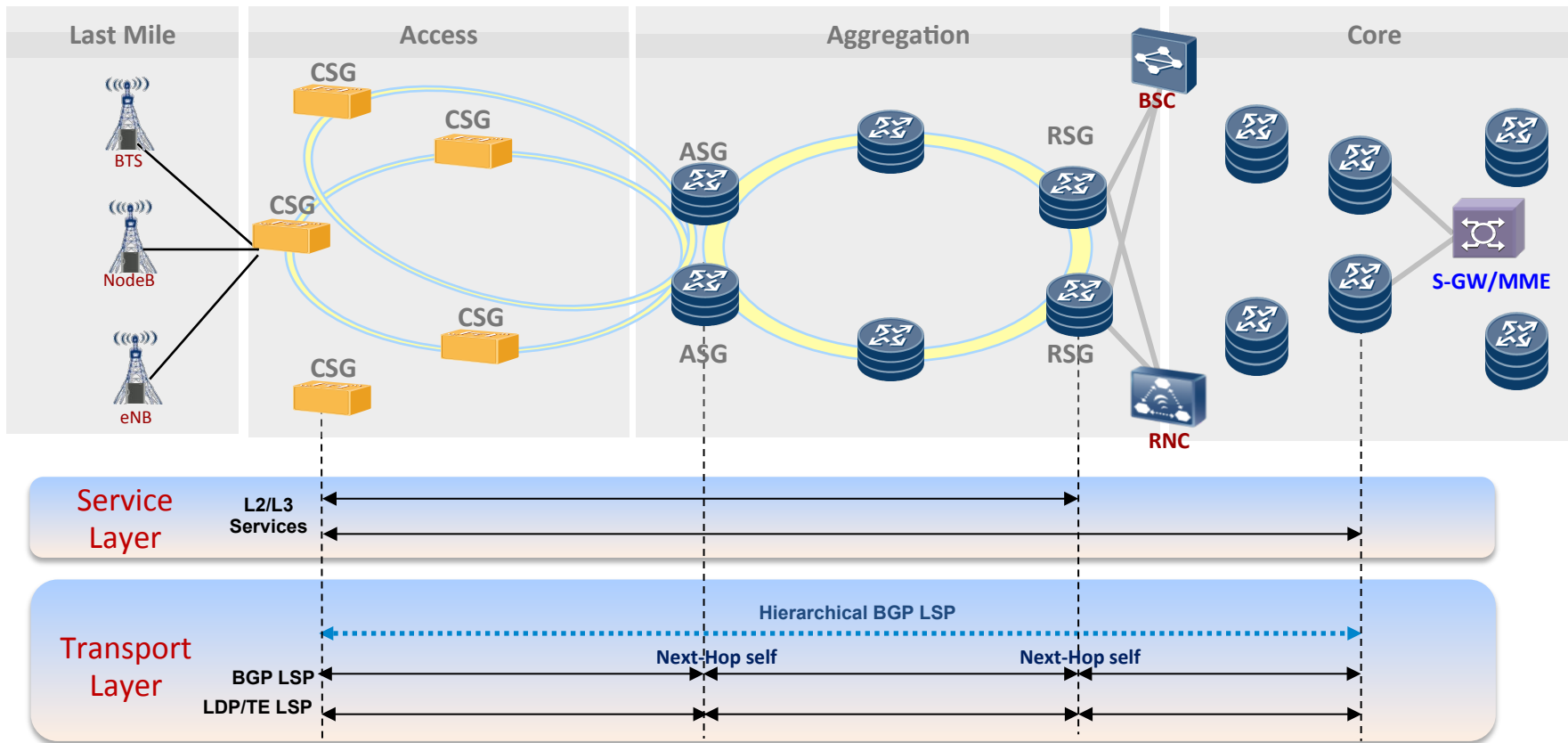

Scenarios for Network Architecture

■ Network Architecture 1: Network separated by Ases

- Scenario 1: ASes connected by different ASBRs
- Scenario 2: ASes connected by integrated ASBRs

■ Different network integrated in one AS but separated by different IGP areas

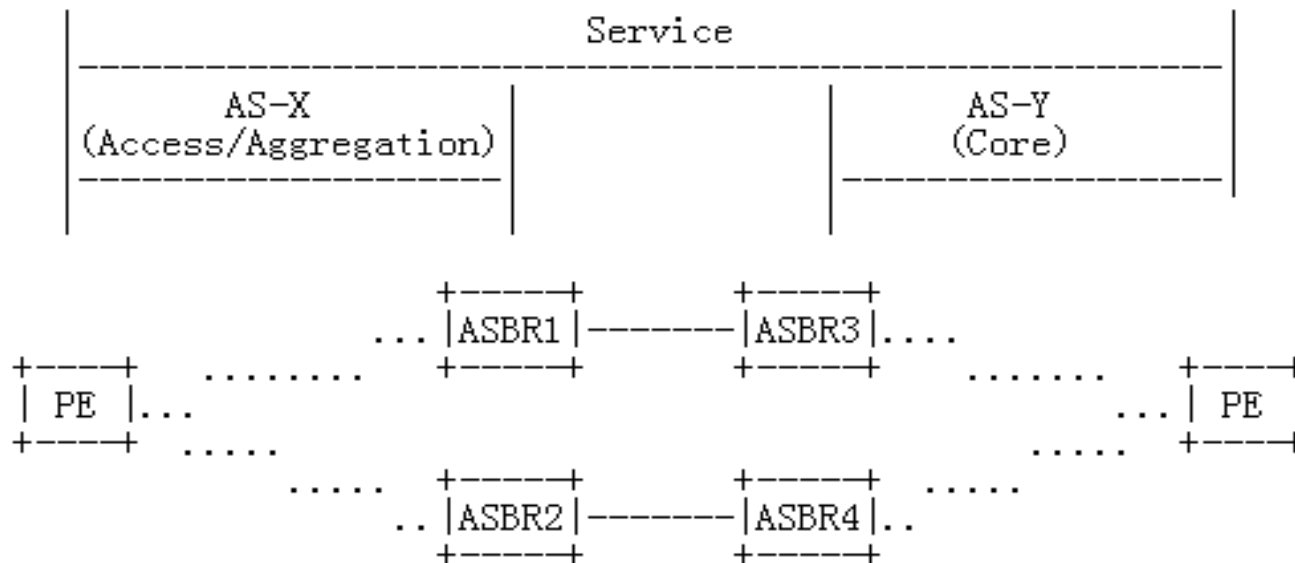
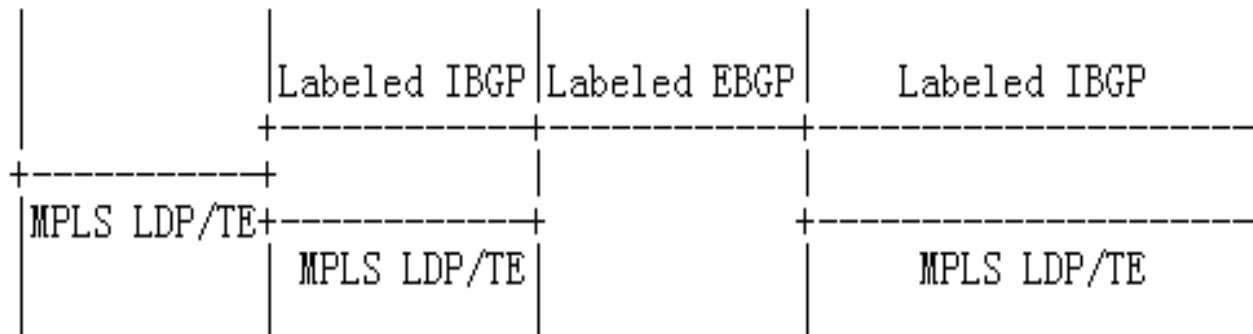
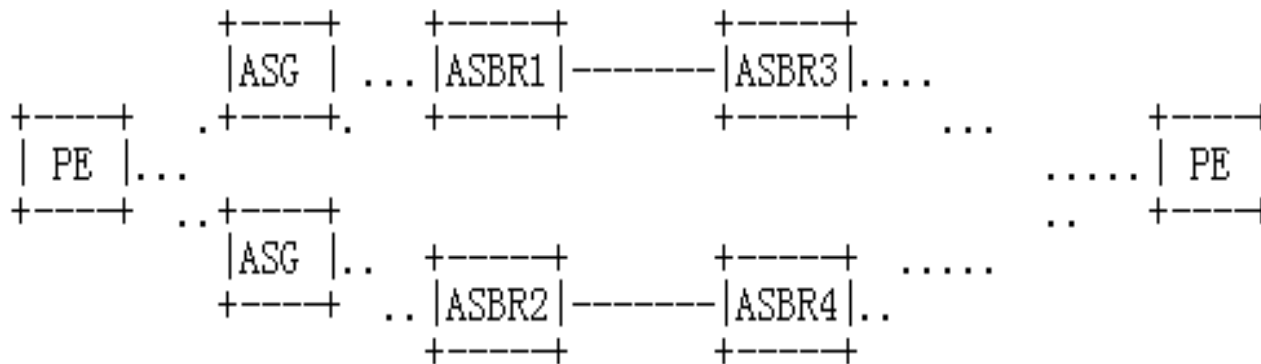

Figure 1 Redundant ASBRs connected Back to Back

Scenarios for Different Edge of Labeled BGP

- Scenario 1: Cell Site/User PE devices as the edge
- Scenario 2: ASG nodes as the edge
- Scenario 3: RSG(ASBR) devices as the edge



Scalability problems and requirements

■ Problem statement

- Tunnel/LSP Configuration

- a set of TE attributes configuration at the ingress node

- Path Constraints Configuration

- Return Path Issue of BFD for MPLS LSPs
- Completely disjointed primary and backup LSP
- Avoid passing through different access rings

■ Requirements

- REQ 01: Auto tunnel mechanism
- REQ 02: cope with the return path issue of BFD
- REQ 03: completely disjointed primary and backup LSP
- REQ 04: avoid traffic passing through different access rings

End-to-End Transport problems and requirements

■ Problem statement

- Proxy Egress MPLS TE LSP

- Actual destination may be not located in the local MBH network
- set up the proxy egress MPLS TE LSP from CSG to stitching point

- Multi-hop LDP DoD

- cannot configure the default route for setup of LDP DoD LSP
- troublesome to configure static routes to a specific destination on all node

■ Requirements

- REQ 11:set up MPLS TE proxy egress LSP to stitch with BGP LSP
- REQ 12:simplify route configuration to setup multi-hop LDP DoD LSP

Hierarchical Service Bearing problems and requirements

■ Problem statement

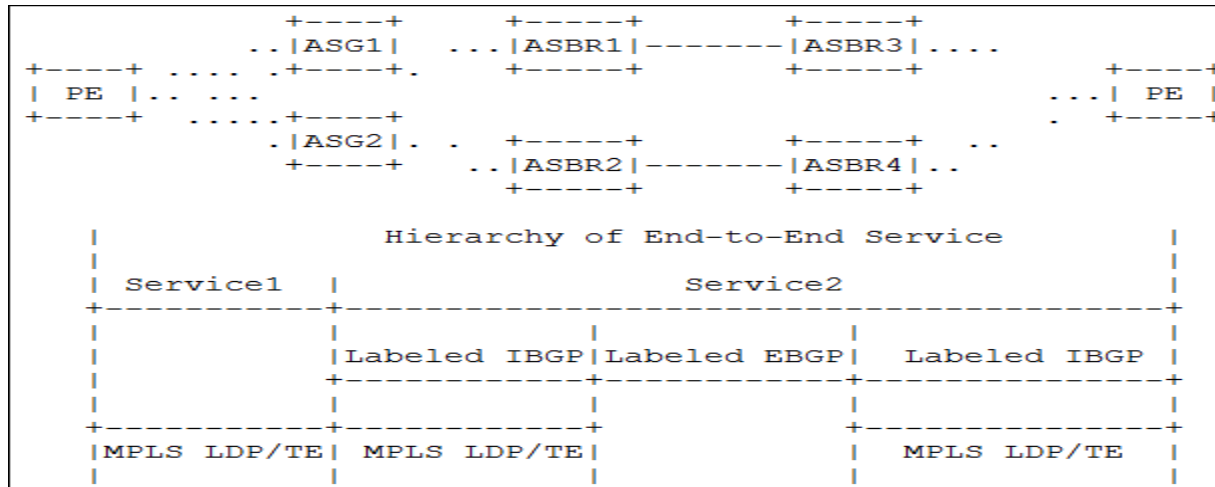

- Owing to the limited capability of access nodes it may be necessary to introduce hierarchical MPLS-based service bearing
- Seamless MPLS is to provide more flexibility for MPLS-based service bearing.

■ Requirements

- REQ 31: hierarchical L3VPN solutions MAY be introduced
- REQ 32: hierarchical L2VPN solutions MAY be introduced

Reliability Transport problems and requirements

■ Problem statement

- The route loop is common in the ring
- LFA can not avoid the route loop completely
- Remote-LFA has to set up LDP remote session and still faces the route loop challenges

■ Requirements

- REQ41: Scalable IP/LDP FRR solutions SHOULD be provided for the purpose of 100% network coverage

Policy Control problems and requirements

■ Problem statement

- Simple and dynamic BGP policy design and configuration
- BGP is asked to carry more information to help select routing more intelligently

■ Requirements

- REQ51: BGP SHOULD be able to carry more information to facilitate the route policy control

OAM problems and requirements (1)

■ Problem statement

● Layering OAM Framework for L3VPN Service

- The existing OAM mechanisms for IP and L3VPN is not sufficient to satisfy the OAM requirement of the mobile service, especially for performance monitoring

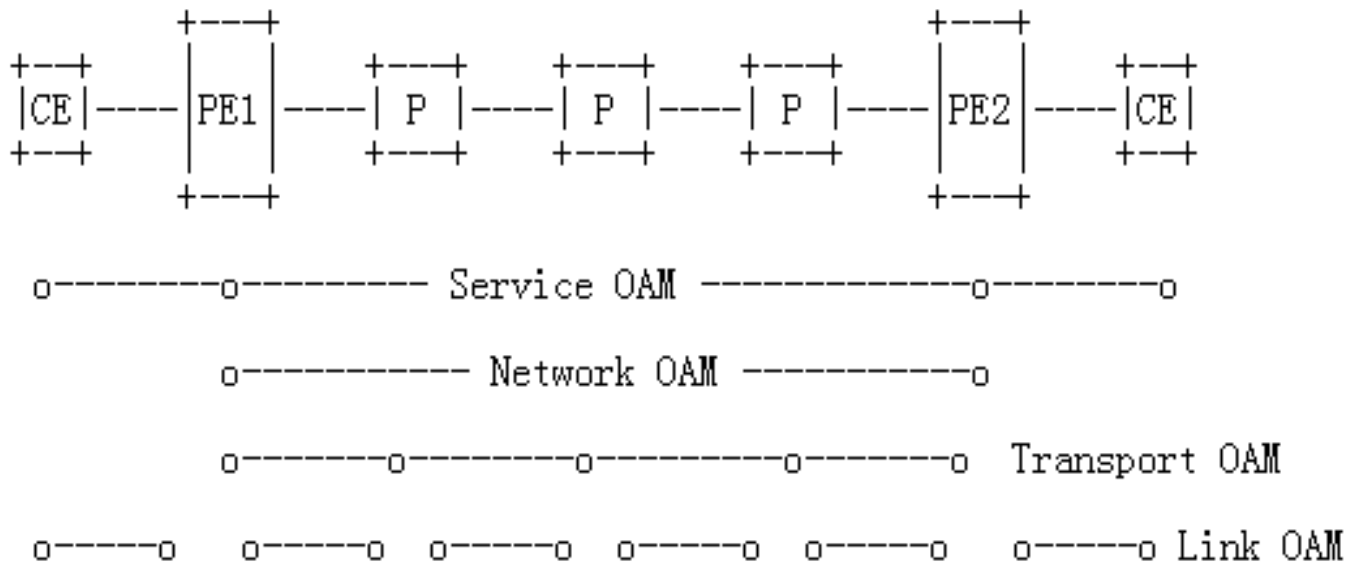

OAM problems and requirements (2)

■ Problem statement

- Flat End-to-End OAM Mechanism

- Can not get the end-to-end path directly.

- Path of OAM packets and real traffic packets may be different

■ Requirements

- REQ61: Performance monitoring mechanism for IP flow

- REQ62: Performance monitoring mechanism for the VPN flow

- REQ63: The end-to-end path trace mechanism for the IP flow

Next Steps

- Solicit more comments and feedback
- Incorporate more requirements and solutions
- Revise the draft