

Updates on the two drafts for PCECC

[draft-zhao-pce-central-controller-user-cases-02.txt](#)

[draft-zhao-pce-pcep-extension-for-pce-controller-01.txt](#)

Quick Review : From LDP/RSVP-TE/Stateful PCE to PCE as Central Controller (PCECC)

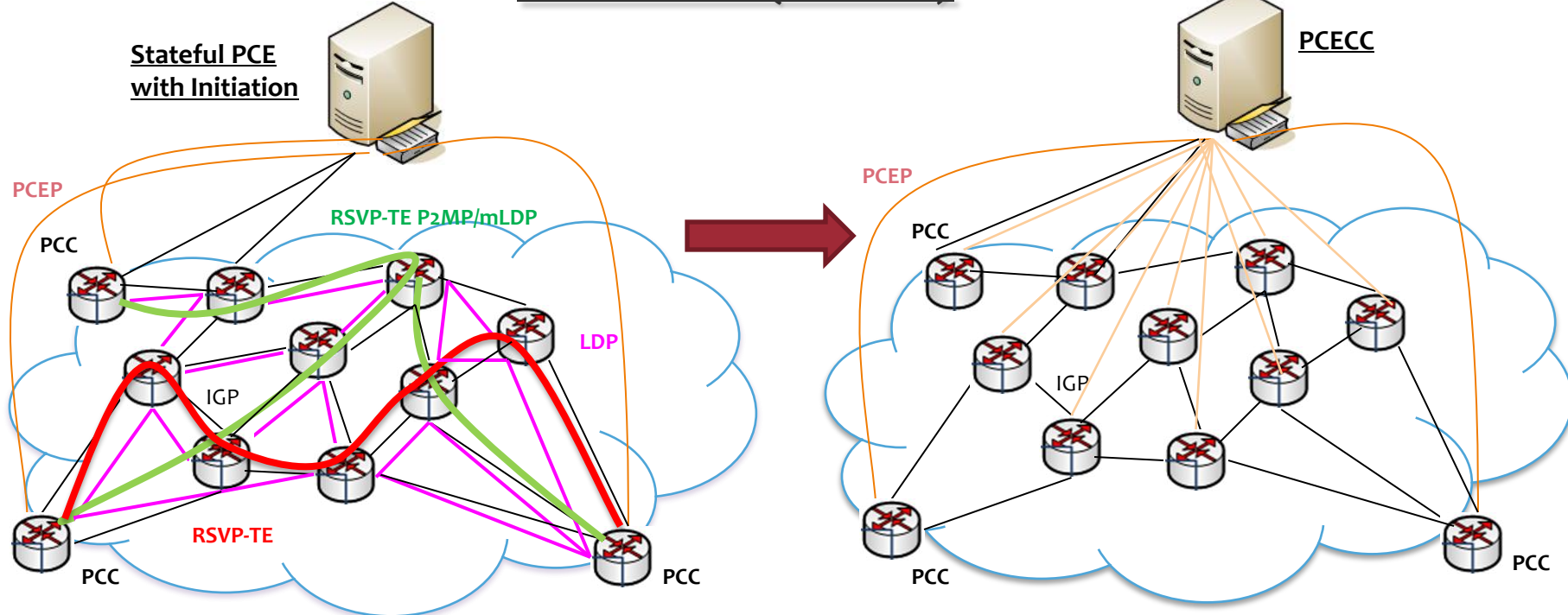

Free from MPLS signaling protocols

PCECC communicates to all nodes

PCECC responsible for label allocation

Central controller to provide more app aware services

Updates on the Two Drafts for PCECC

1. More people contributed to this work and joined these two drafts as co-authors: Udayasree Palle, Richard Li, Luyuan Fang, Chao Zhou,
2. In the use case draft, the L3VPN and PWE3 use cases are added.

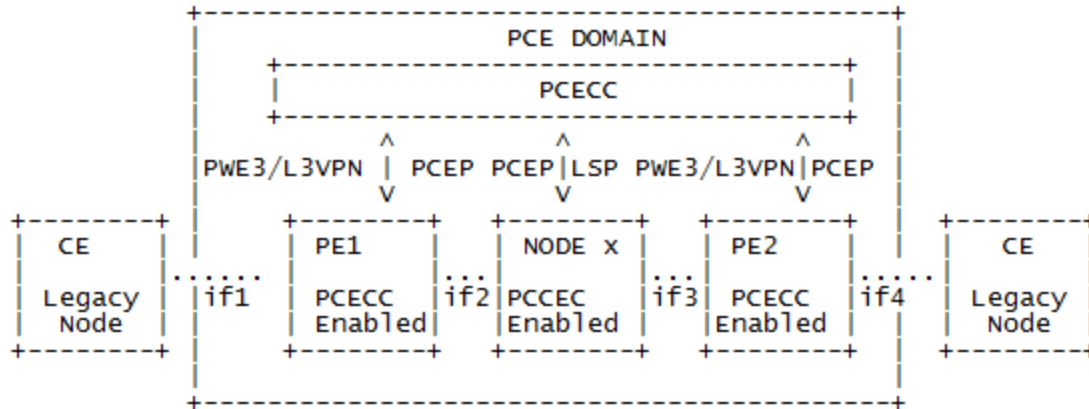

Updates on the Two Drafts for PCECC (continue)

3. In the protocol extension draft, the details for the protocol extensions are added.

The format of the PCLabelUpd message is as follows:

```
<PCLabelUpd Message> ::= <Common Header>
                             <pce-label-update-list>
Where:
<pce-label-update-list> ::= <pce-label-update>
                             [<pce-label-update-list>]
<pce-label-update> ::= (<pce-label-download>|<pce-label-map>)
Where:
<pce-label-download> ::= <SRP>
                             <LSP>
                             <label-list>
<pce-label-map> ::= <SRP>
                             <LABEL>
                             <FEC>
<label-list > ::= <LABEL>
                             [<label-list>]
```

To download labels along the path of the LSP for Basic (TE-LSP) mode

To send label mapping with FEC for node and adjacency labels (SR LSP)

Our Experiments with PCECC

1. MPLS VPN Service

- ❑ PCECC TE LSP
- ❑ PCECC SR LSP

2. Performance Analysis

MPLS VPN Service

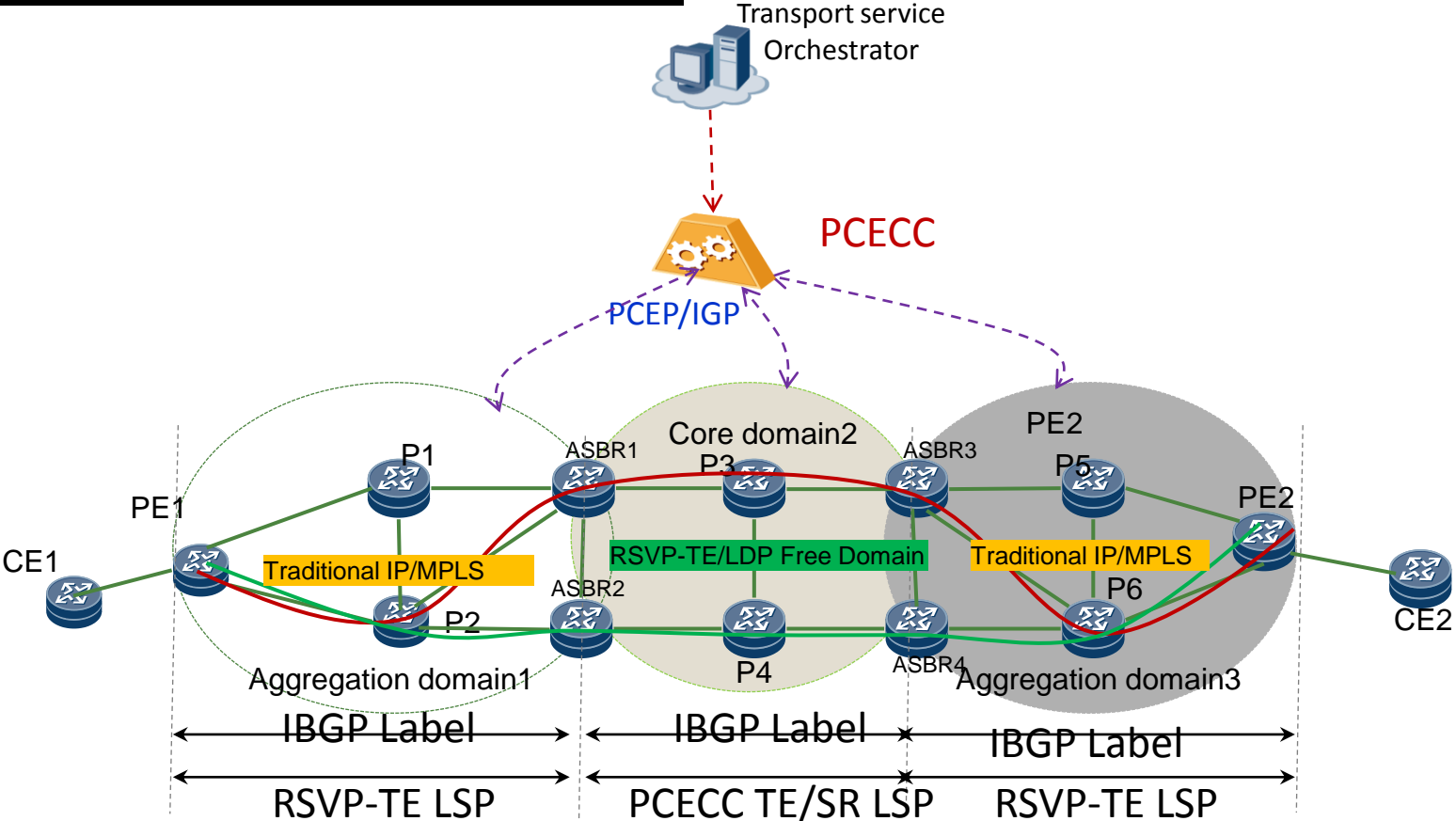

PCECC-TE LSP

1. Request PCECC to initiate LSP

2. PCECC computes the path and allocates label along the path for each node

3. PCE sends PCInitiate message to the ingress and Ingress sends PCRpt message back

4. PCECC sends PCLabelUpd to each node along the path with label information to download

5. PCECC sends PCUpd to the ingress and PCC sends PCRpt back with status-up.

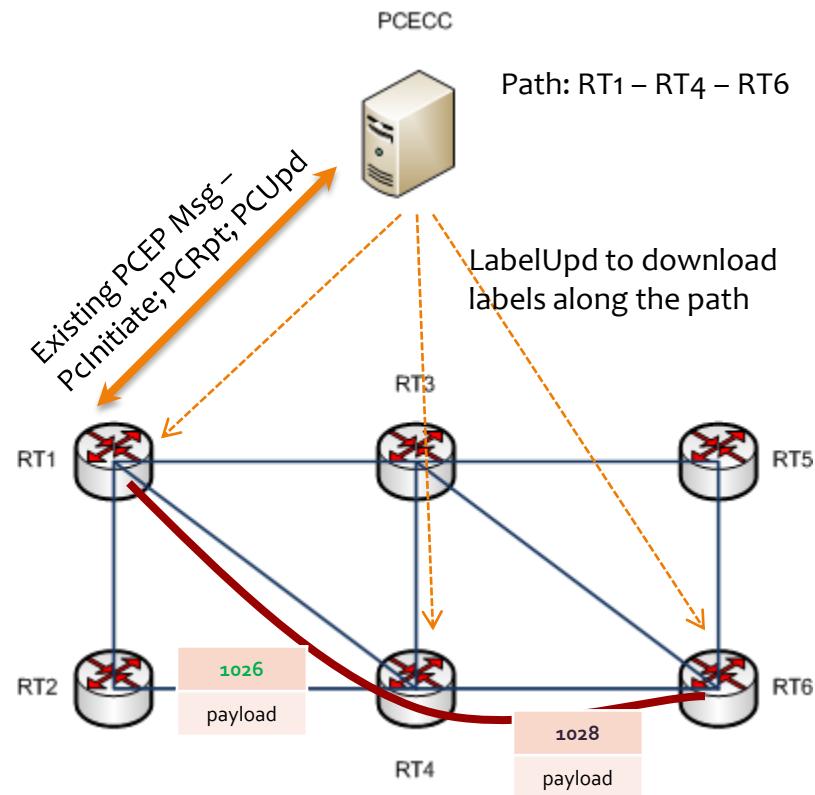

PCECC – SR LSP

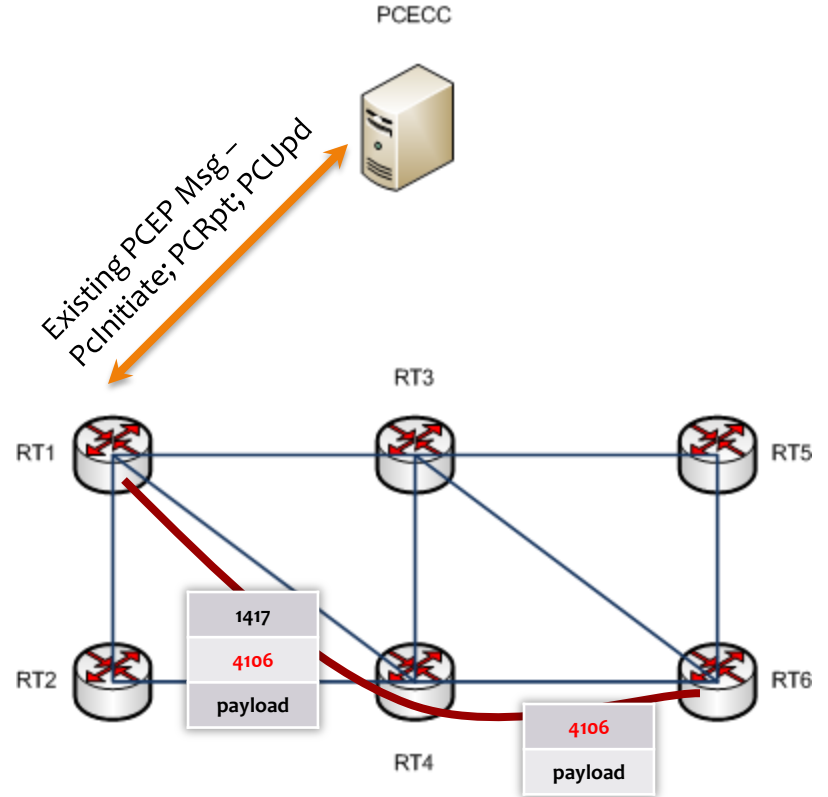
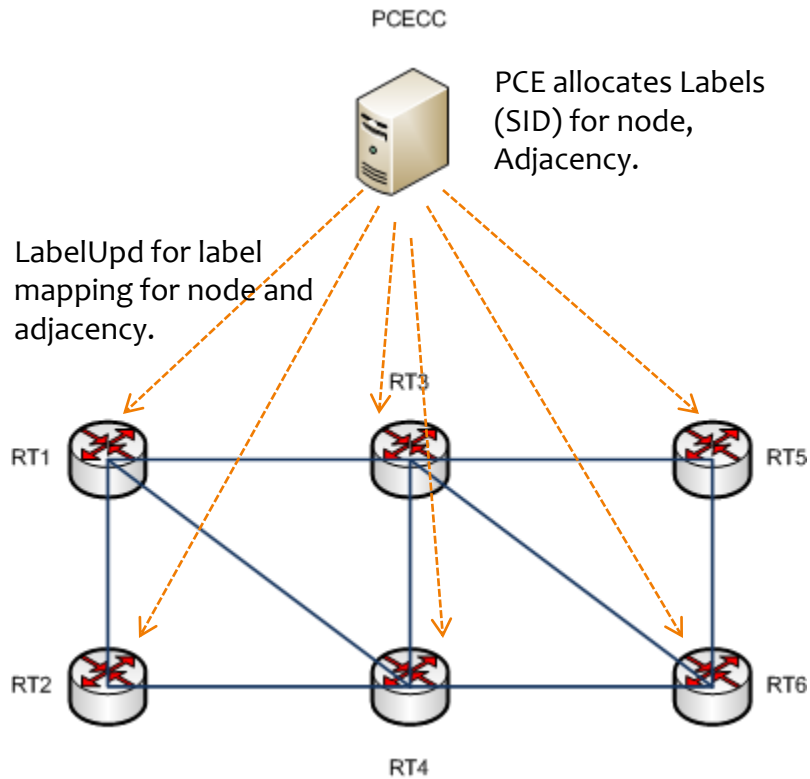

PCECC Performance Test

PCECC

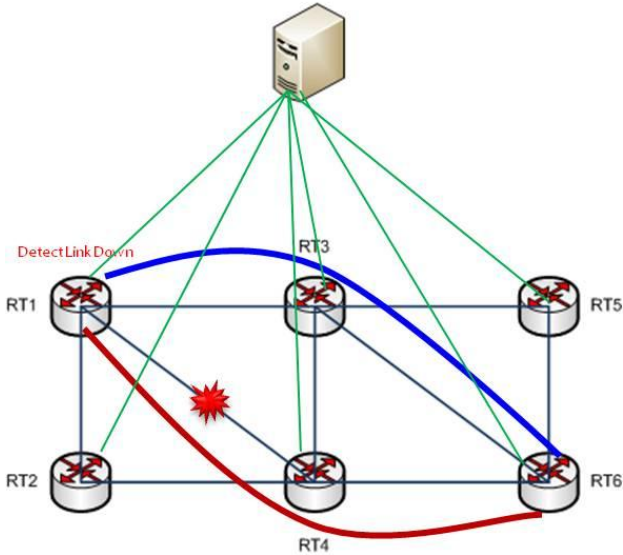

Convergence Time

The Number of LSPs

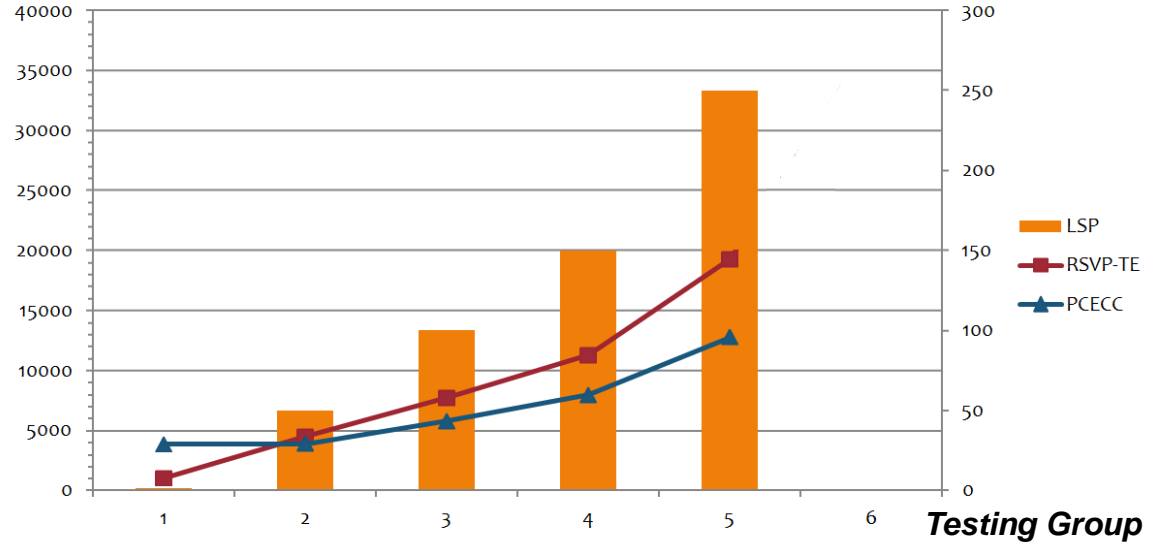

Next Step with PCECC

1. Get more feedbacks from the working group and users
2. Work on End to End and local Protections (MT/FRR/LFA etc)
3. Do more scalability analysis
4. Consider the PCECC redundancy
5. More application scenarios.

If you are interested in any specific application scenario and would like to see demos for PCECC, please let us know

⋮
Any comments/suggestions/questions are welcome!

Thanks!