



IETF 93 ROLL

Routing over Low-Power And Lossy Networks

Chairs:

Michael Richardson

Ines Robles



Note Well

Any submission to the IETF intended by the Contributor for publication as all or part of an IETF Internet-Draft or RFC and any statement made within the context of an IETF activity is considered an "IETF Contribution". Such statements include oral statements in IETF sessions, as well as written and electronic communications made at any time or place, which are addressed to:

- The IETF plenary session
- The IESG, or any member thereof on behalf of the IESG
- Any IETF mailing list, including the IETF list itself, any working group or design team list, or any other list functioning under IETF auspices
- Any IETF working group or portion thereof
- Any Birds of a Feather (BOF) session
- The IAB or any member thereof on behalf of the IAB
- The RFC Editor or the Internet-Drafts function

All IETF Contributions are subject to the rules of [RFC 5378](#) and [RFC 3979](#) (updated by [RFC 4879](#)).

Statements made outside of an IETF session, mailing list or other function, that are clearly not intended to be input to an IETF activity, group or function, are not IETF Contributions in the context of this notice. Please consult [RFC 5378](#) and [RFC 3979](#) for details.

A participant in any IETF activity is deemed to accept all IETF rules of process, as documented in Best Current Practices RFCs and IESG Statements.

A participant in any IETF activity acknowledges that written, audio and video records of meetings may be made and may be available to the public.

Source: <https://www.ietf.org/about/note-well.html>

Meeting Materials

- Remote Participation
 - Jabber Room: roll@jabber.ietf.org
 - Meetecho: <http://www.meetecho.com/ietf93/roll>
- Etherpad:
 - <http://tools.ietf.org/wg/roll/minutes>
- Audio Streaming: <https://congresshall1.conf.meetecho.com/meetecho/login.jsp?ietf=roll>
- Minutes taker:
- Jabber Scribe:
- **Please sign blue sheets :-)**

Agenda

- State of: (10 minutes)
 - Work item
 - ROLL I-D
 - Related I-D
 - Open Issues
- Liaison on concerns on the deprecation of dispatch type in 6LoWPAN and its header compression mechanism to roll (10 min)
- draft-robles-roll-useofrplinfo-00 (18 min)
- draft-thubert-roll-dao-projection-00 (20 min)
- Open floor (2 minute)

Milestones (cont.)

Milestone	Schedule
Submit draft about when to use RFC 6553, RFC 6554, and IPv6-in-IPv6 encapsulation to the IESG.	Aug 2015
Submit draft about how to compress RFC 6553, RFC 6554, and IP headers in the 6LoWPAN adaptation layer context to the IESG.	Nov 2015
Evaluate WG progress, recharter or close	Nov 2015

State of Active Internet-Drafts

draft-ietf-roll-admin-local-policy-03	RFC Editor Queue
draft-ietf-roll-applicability-ami-10	Addressing Issues from LC
draft-ietf-roll-applicability-home-building-12	New Version - Issues from LC Addressed
draft-ietf-roll-applicability-template-07	Stable - not to be published
draft-ietf-roll-trickle-mcast-12	RFC Editor Queue
draft-ietf-roll-mpl-parameter-configuration-06	In IESG, Issues to be addressed from LC.

Related Internet-Drafts

draft-robles-roll-useofrplinfo-00	Energy-awareness metrics global applicability guidelines	Slides Today
draft-thubert-roll-dao-projection-00	Root initiated routing state in RPL	Slides Today
draft-tan-roll-clustering-00	RPL-based Clustering Routing Protocol	Future Discussion

Open Tickets

Ticket	Summary
#169	Work Item Proposals
#170	Use of ESC Dispatch value in new IETF header compression
#171	Int-Dir review of draft-ietf-roll-mpl-parameter-configuration-06

Liaison from ITU-T SG15 to ROLL and 6Lo

<https://datatracker.ietf.org/liaison/1415/>

ITU-T Study Group 15 has been designated as the lead study group for communications-related aspects of Smart Grid. Question 15 (Q15/15) is responsible for Recommendations ITU-T G.9903 (Narrow-band OFDM power line communication transceivers for G3-PLC networks – approved in 02/2014) and ITU-T G.9905 (Centralized Metric based Source Routing – approved in 07/2013).

These two Recommendations normatively reference 6LoWPAN (RFC 4944) and its header compression mechanism (RFC6282).

We would like to bring to your attention that on-going discussion in IETF 6lo and ROLL WGs on reusing the ESC and MESH dispatch headers for route-over and mixed operations may lead IETF to deprecate the possibility of using RFC4944 and/or RFC6282 in pure mesh-under networks. This deprecation would create a conflict with Recommendation ITU-T G.9903 and possibly also other standards.

Details on [how ITU-T G.9903 uses the ESC and MESH dispatch headers](#), confirming how important the stability of the 6LoWPAN standard and related IANA allocations are for ITU-T G.9903:

1. ITU-T G.9903 provides native mesh-under functionalities (the LOADng protocol, which is described in Annex D) while not prohibiting the use of other mesh-under (e.g. CMSR specified in ITU-T G.9905) or route-over routing protocols. If other routing protocols are used, then the native mesh-under LOADng protocol can be disabled.

a. The **first octet** corresponds to the **ESC Dispatch Header as specified in RFC 6282, i.e. 0b10 000 000**.

b. The **second octet** corresponds to the **command ID**. As specified in Table 9-35/G.9903, three possible commands are currently specified (additional commands can be specified to support other routing protocols):

- i. o LOADng command frame
- ii. o loWPAN bootstrapping command frame
- iii. o CMSR command frame (see ITU-T G.9905).

c. The **rest of the frame** carries the **payload** for the relevant command frame.

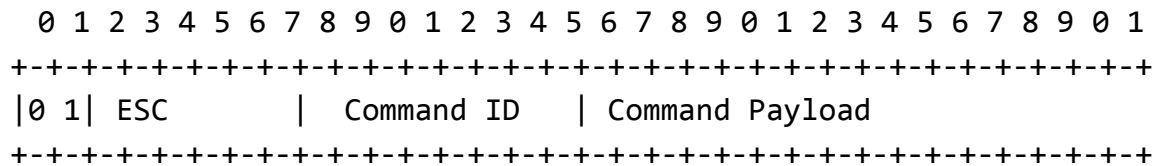

G.9903 Frame Format with ESC Byte (draft-chairs-6lo-dispatch-iana-registry-00)

2. The **ESC Dispatch Header** is used by ITU-T G.9903 exclusively for **command frames**. A command frame is built as follows (see Figure 9-12/ G.9903):
3. During the bootstrapping phase, the **6LOWPAN_IPHC** and **ESC headers** are present in the same frame. The ESC dispatch header is placed after the 6LOWPAN_IPHC header.
4. The **MESH Header as specified** in RFC 4944 is used for data frames only and contains vital information for the **correct delivery of G.9903** data frames when the mesh-under LOADng routing protocol is used.

As of today, **Japan and France** have already **started deployment of ITU-T G.9903 smart meters** (in France smart meters will represent a total of 32 million ITU-T G.9903 smart meters – 100% national coverage – by 2021). There are also deployed wireless technologies for smart metering (e.g., based on 802.15.4) that support layer 2 mesh routing as well. Furthermore, interest in such technologies transcends smart metering applications and includes a broader set of Smart Grid applications and beyond, making ITU-T G.9903 an important enabler also for IoT applications.

As several existing standards/products rely on using the Dispatch ESC Header for exchanging mesh-under routing and bootstrapping command messages, we would like to bring to your attention that deprecating this feature would have detrimental effects on Smart Grid plans of several countries and utilities:

- Planned deployments would have to be delayed until a viable alternative is found, standardized, and tested in the field. This would make several utilities in the world inevitably incur high costs.
- Future deployments based on the above alternative would be non-interoperable with the currently installed base of devices that rely on the availability of the Dispatch ESC Header.
- **Any delay would put at risk complying with deadlines set by regulators of several countries.** One notable example is the 2008 Directive from the European Union which mandates EU countries to deploy 80% of smart meters by 2020.

ITU encourages IETF to:

- **Avoid deprecation of the ESC and MESH dispatch headers** and look for alternative solutions that do not create conflict with existing standards and products.
- Work in cooperation with Q15/15 to find alternate solutions that do not create conflicts with ITU-T Recommendations.

Q15/15 looks forward to continued cooperation with IETF.

ROLL is going to work with 6Lo

- Answer to ITU-T about:
 - IETF will not make any changes which will adversely affect G.9903.
 - IETF will also collaborate with ITU-T SG15 to create an IANA registry for the codepoints used in G.9903.

Consensus?



When to use RFC 6553, 6554 and IPv6-in-IPv6 draft-robles-roll-useofrplinfo-00

MICHAEL RICHARDSON

INES ROBLES



Goal:

This document states different cases where RFC 6553, RFC 6554 and IPv6-in-IPv6 encapsulation is required to set the bases to help defining the compression of RPL routing information in LLN environments.

Why we need?

RFC 6553: to transmit routing information using HBH (RPL Option) e.g. loop avoidance

RFC 6554: provides Source Routing Header (SRH) for use strictly between RPL routers

IP-in-IP: useful when we want to transmit a packet without modify it.

Scenarios

-Flow from leaf to root

	Storing	Non - Storing
RFC 6553	<ul style="list-style-type: none">- Is that possible, how?- Packet example- something else????	
RFC 6554		
IPv6-in-IPv6		

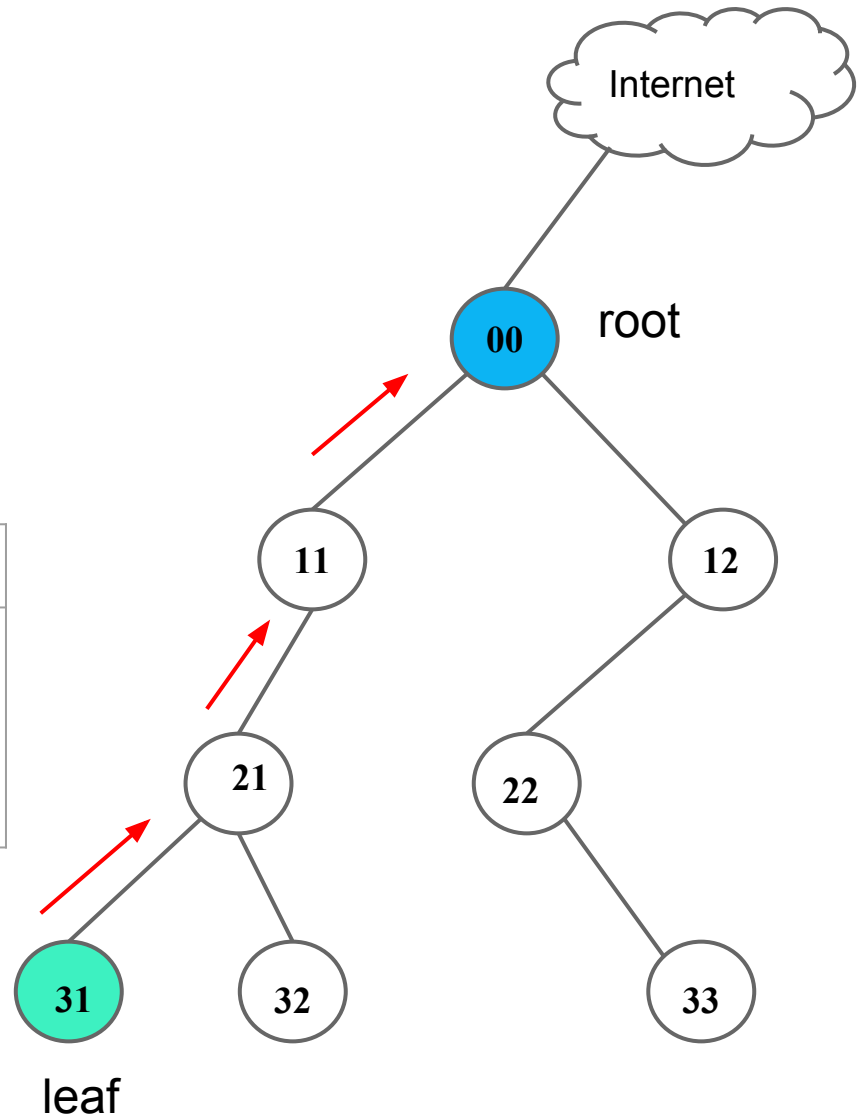

Scenarios

-Flow from leaf to Internet

	Storing	Non - Storing
RFC 6553	<ul style="list-style-type: none">- Is that possible, how?- Packet example- something else????	
RFC 6554		
IPv6-in-IPv6		

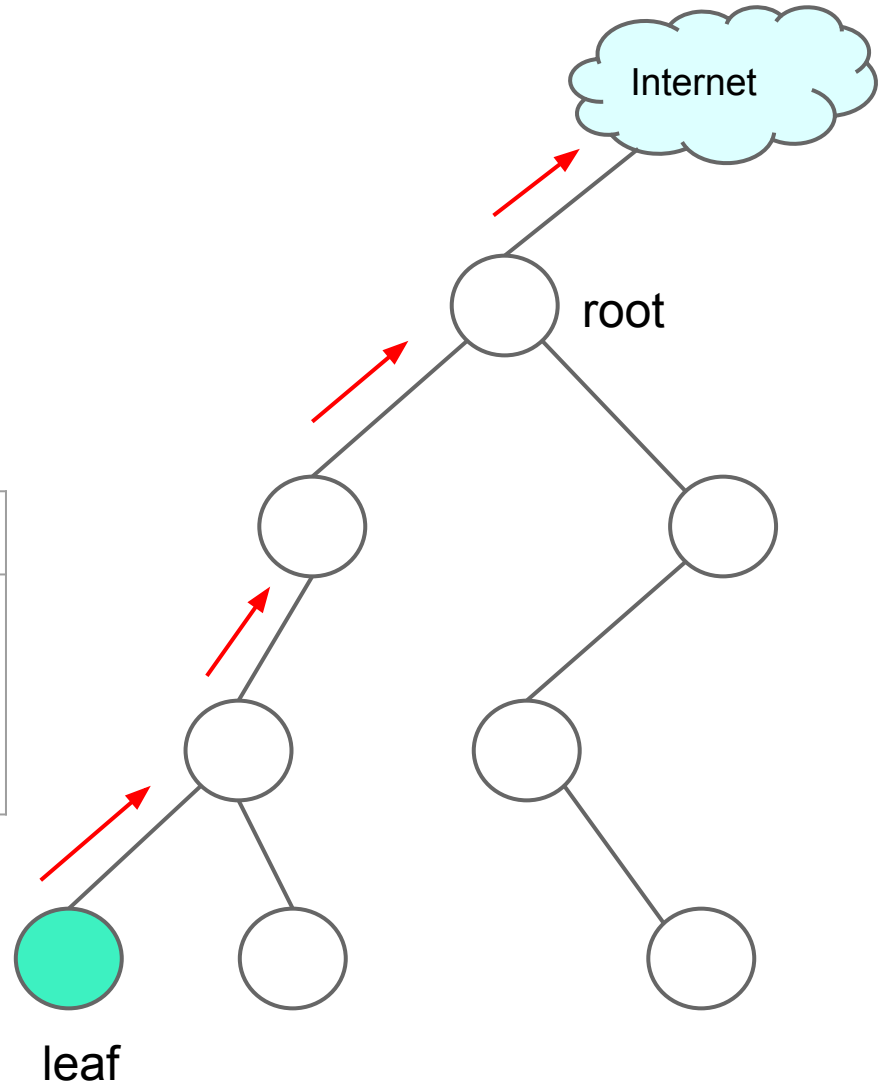

Scenarios

-Flow from leaf to leaf

	Storing	Non - Storing
RFC 6553	<ul style="list-style-type: none">- Is that possible, how?- Packet example- something else????	
RFC 6554		
IPv6-in-IPv6		

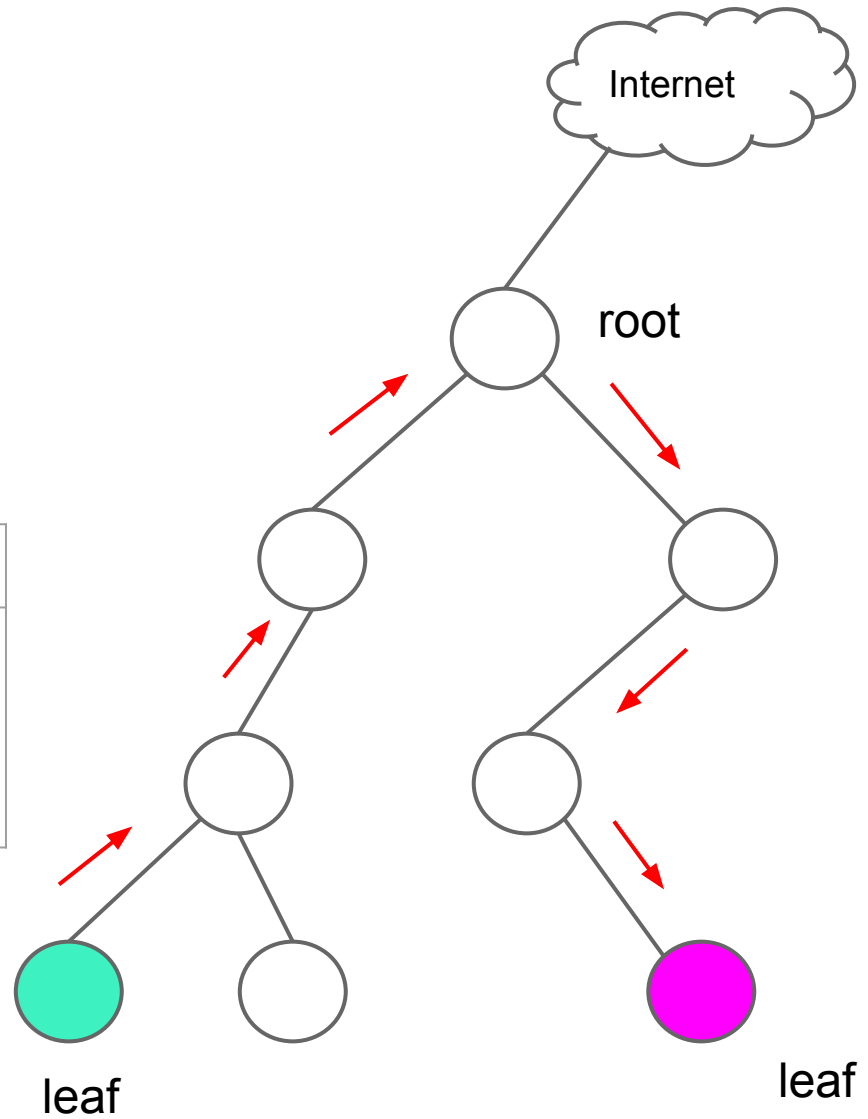

Scenarios

-Flow from Internet to leaf

	Storing	Non - Storing
RFC 6553	<ul style="list-style-type: none">- Is that possible, how?- Packet example- something else????	
RFC 6554		
IPv6-in-IPv6		

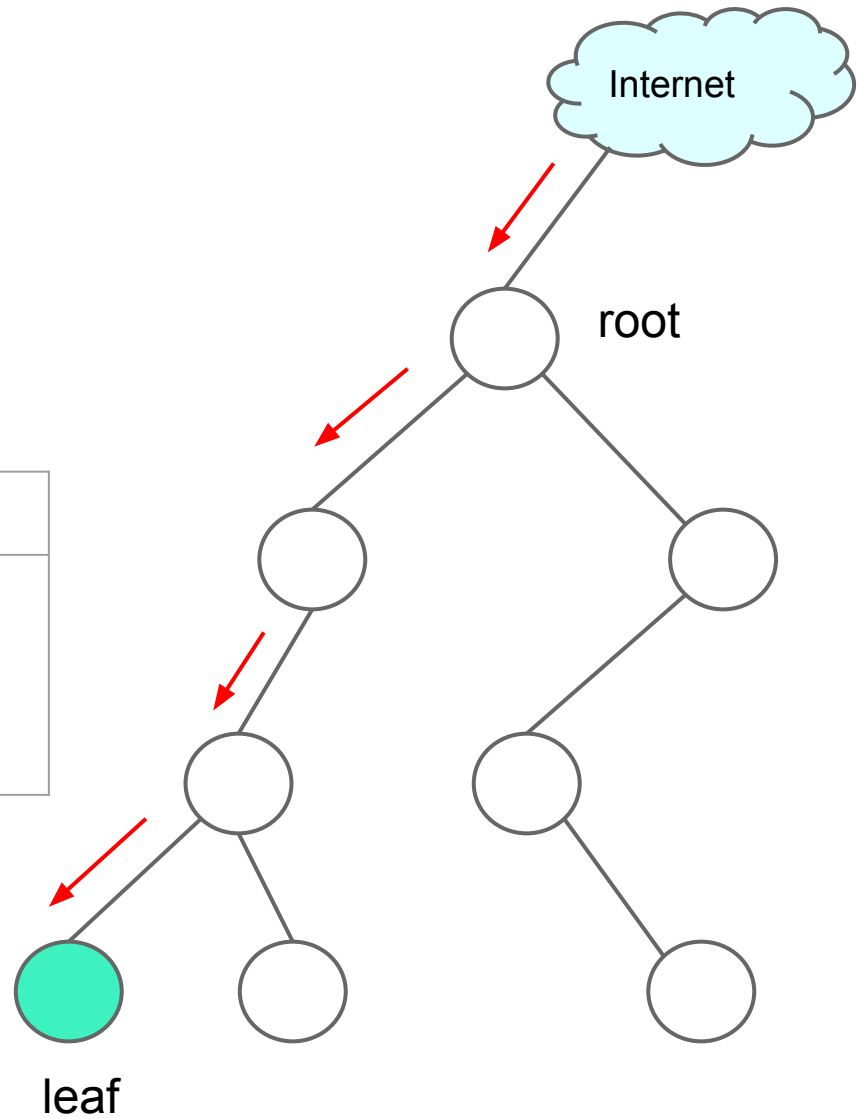

Scenarios

-Flow from root to leaf

	Storing	Non - Storing
RFC 6553	<ul style="list-style-type: none">- Is that possible, how?- Packet example- something else????	
RFC 6554		
IPv6-in-IPv6		

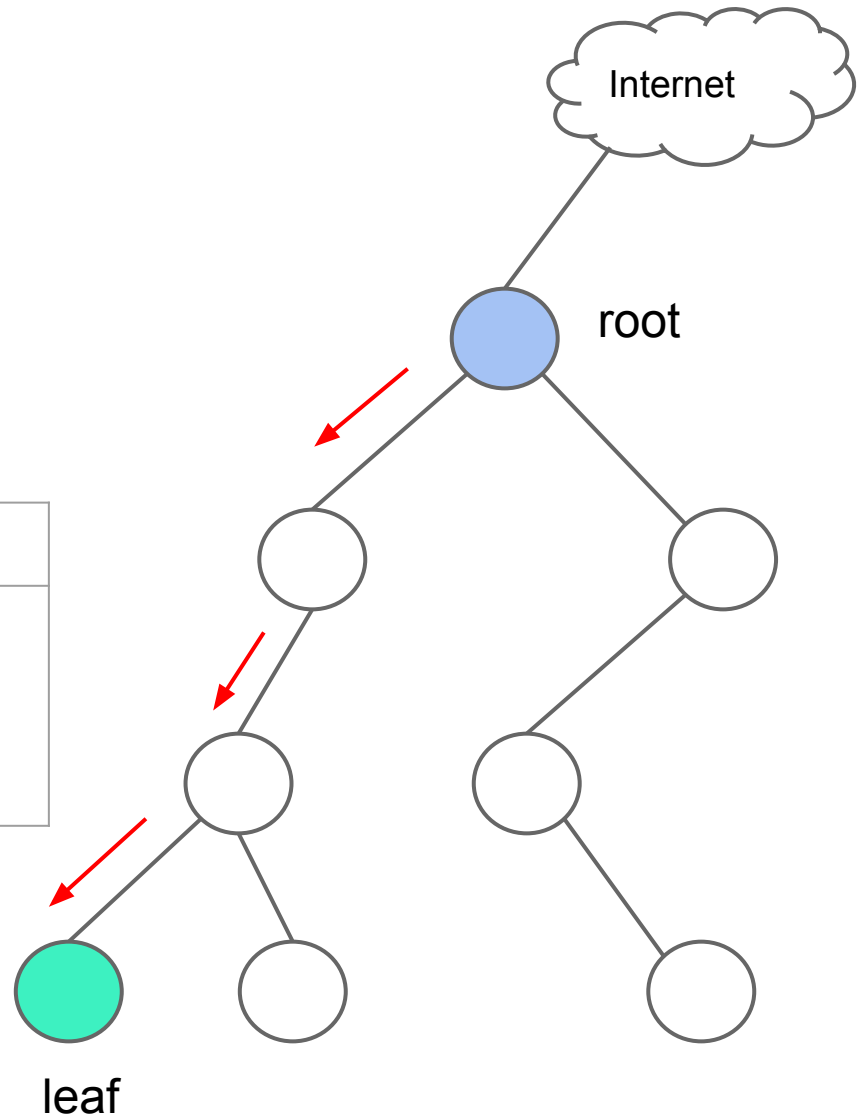

Are there additional scenarios which will have interesting requirements?

For each scenario, do we always need all of 6553, 6554 and IPIP?

THANKS!



Root initiated routing state in RPL

[draft-thubert-dao-projection](#)

Pascal Thubert

IETF 93

Prague, July 2025





Application
Server D

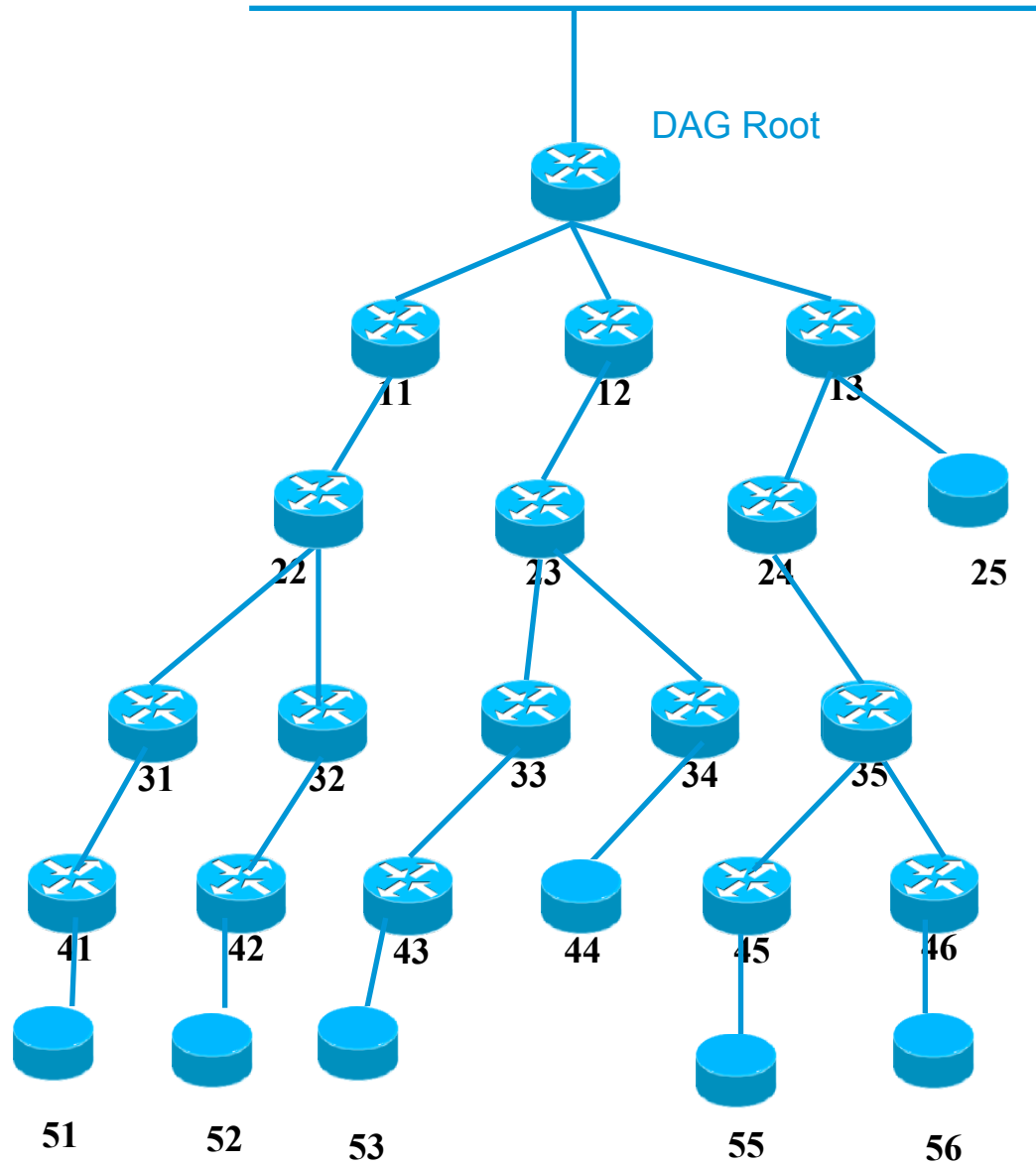

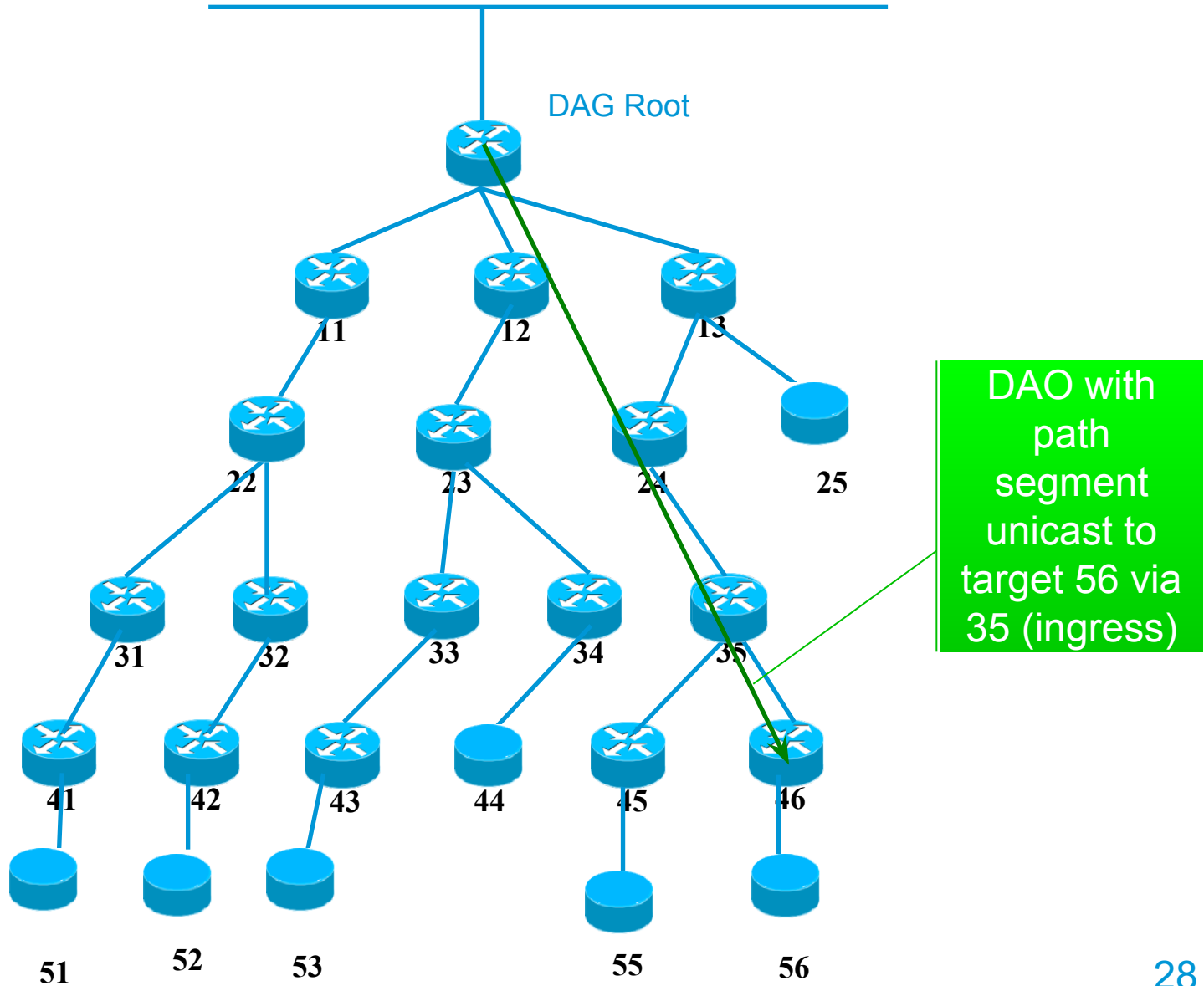



Application Server D

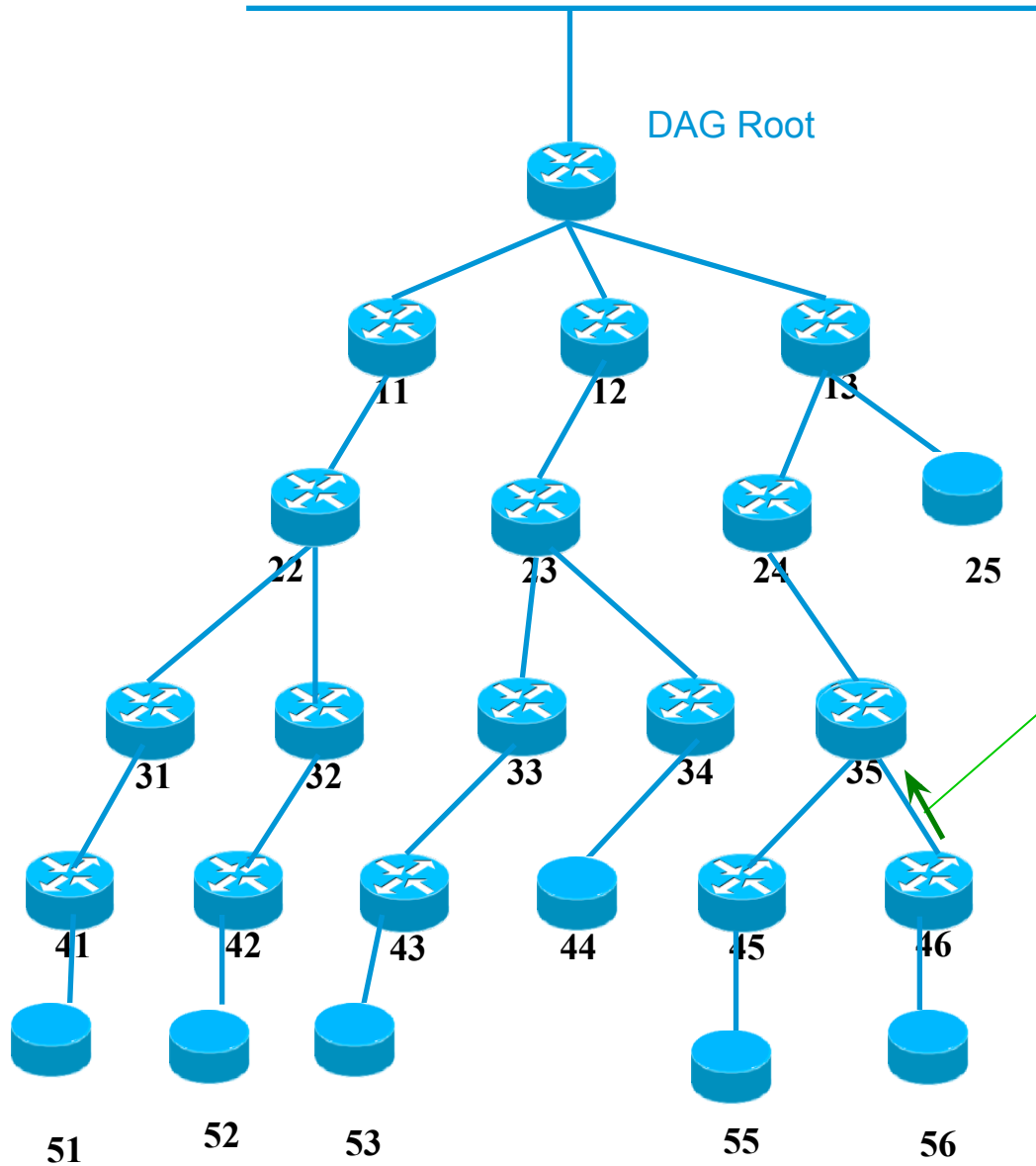

Storing mode DAO (forced) with lifetime along segment



Application
Server D

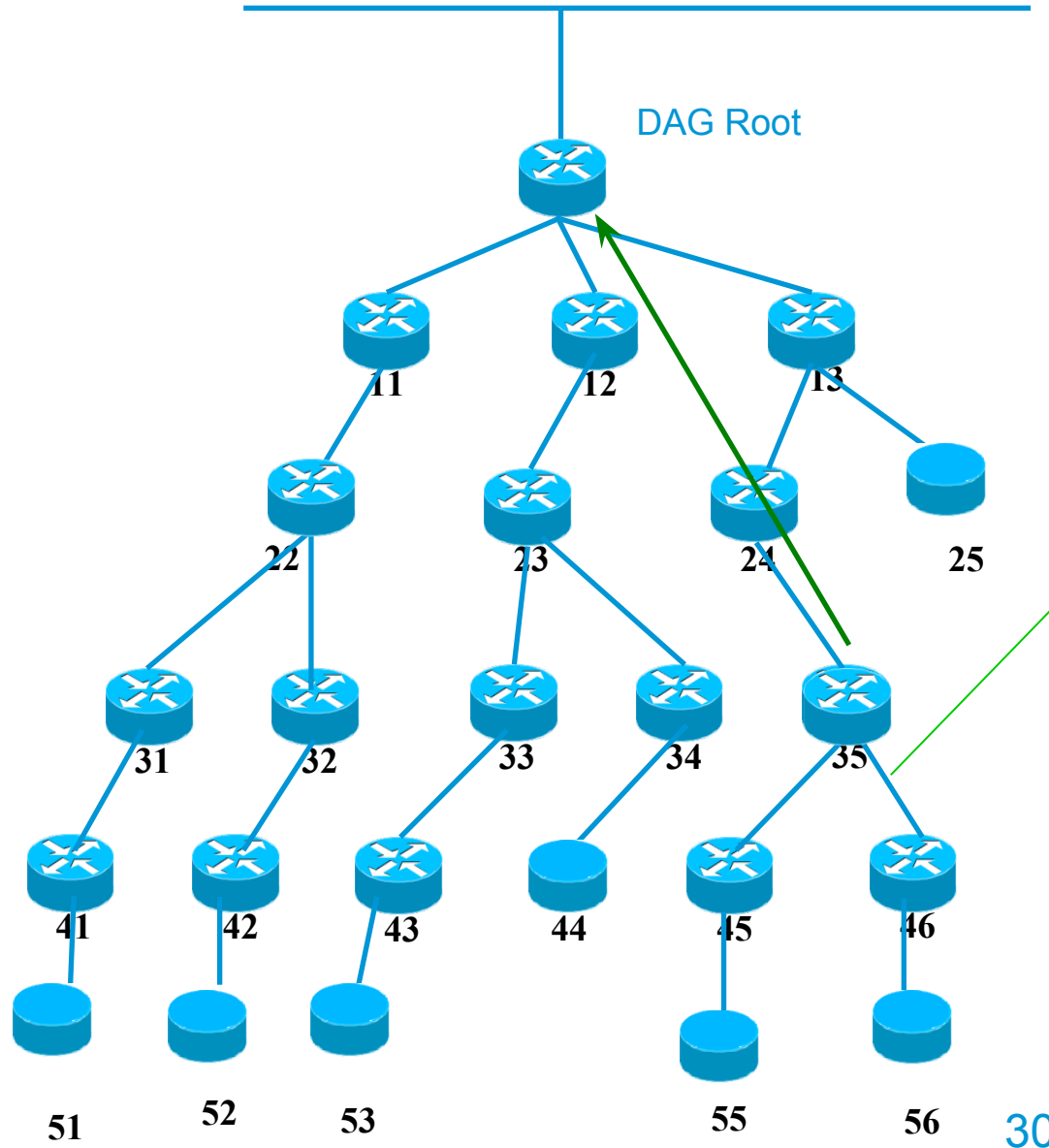

DAO-ACK
(alt: non
storing
DAO)
unicast, self
35 as
parent, final
destination
56 as target



Application Server D

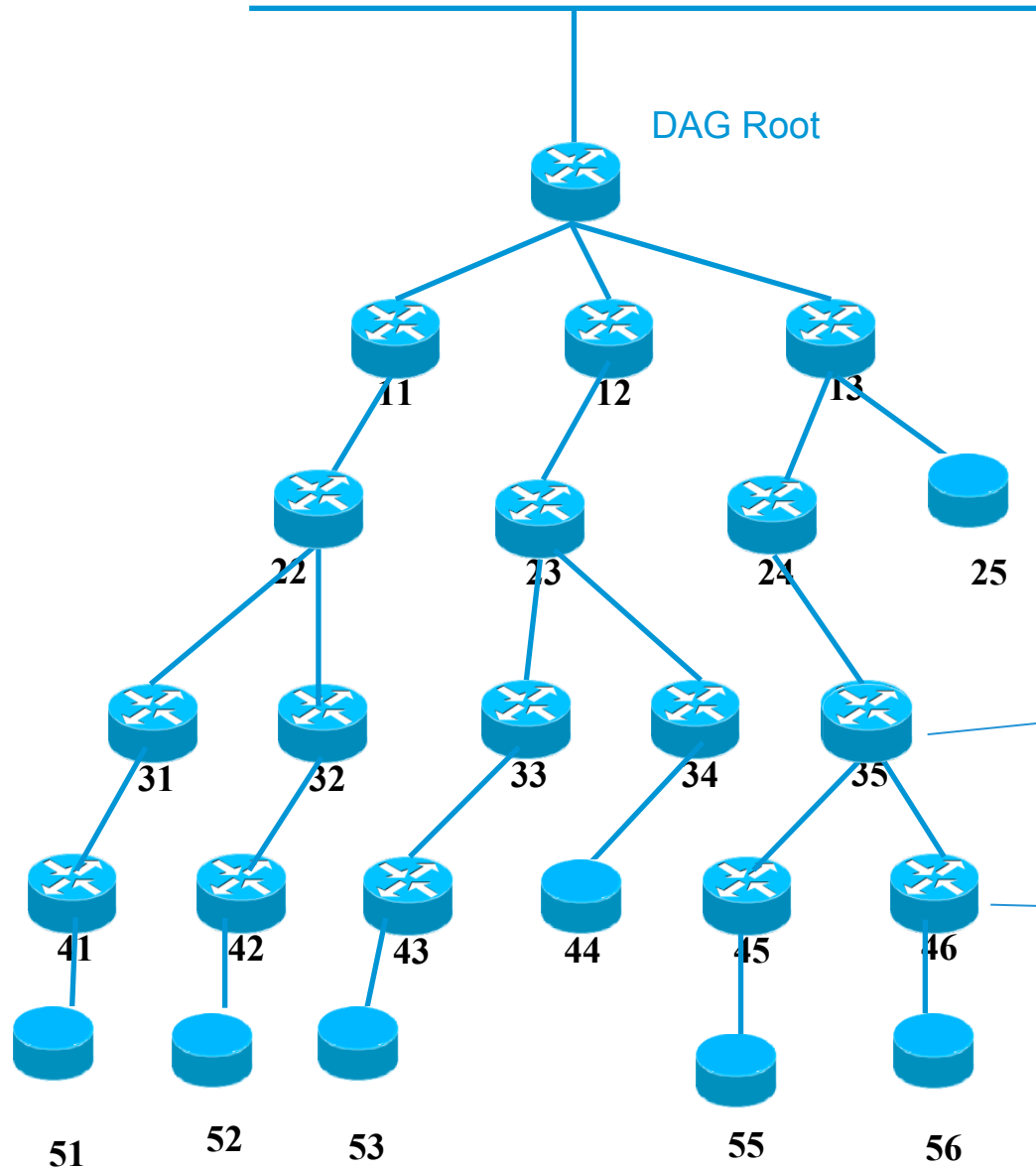

DAO from 46 installs a route to 56 in 35 (all nodes in projected route from ingress included to egress excluded) => egress should already have a route to target

56 via 46

Preexisting connected route to 56



Application Server D

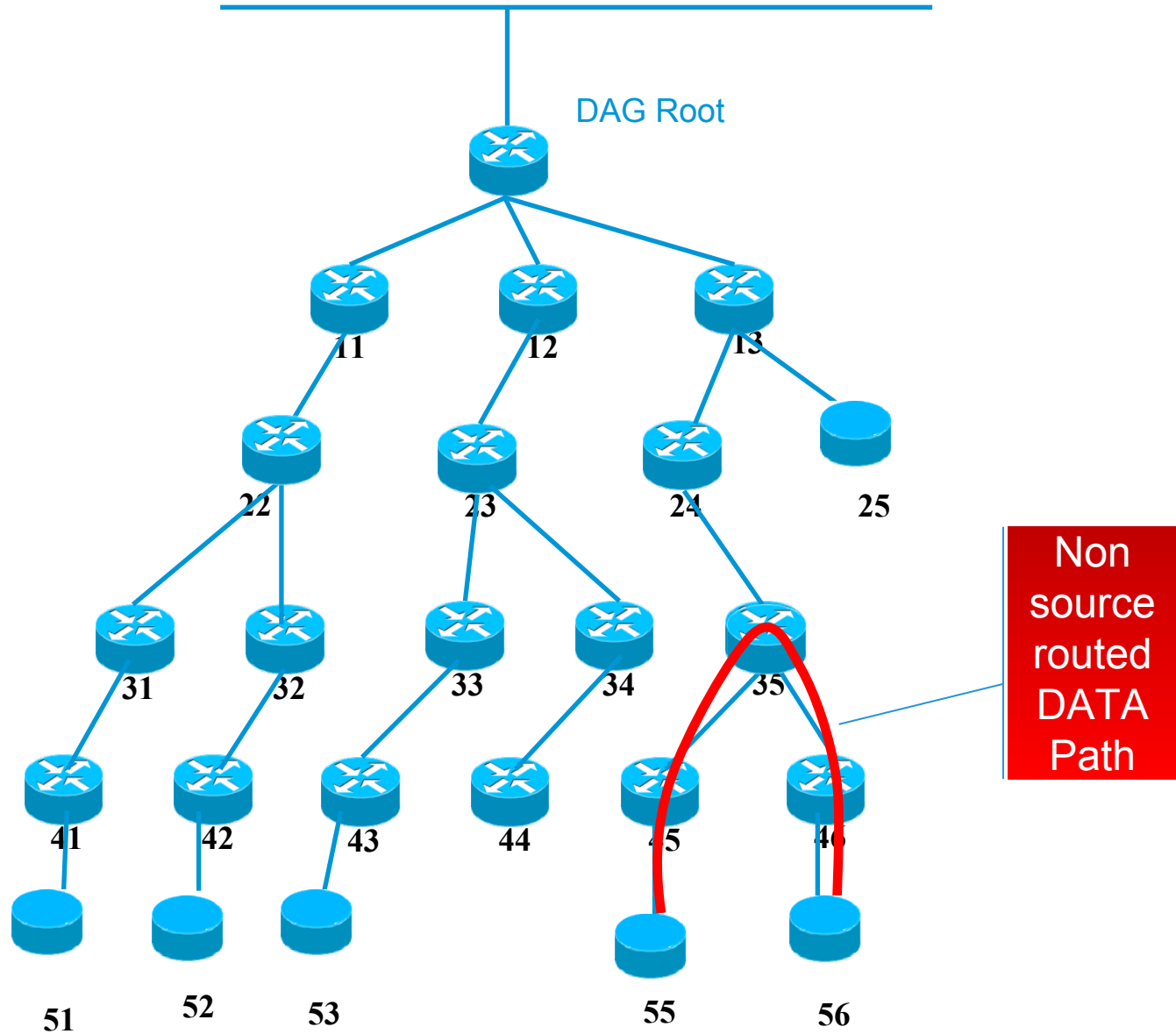



Application Server D

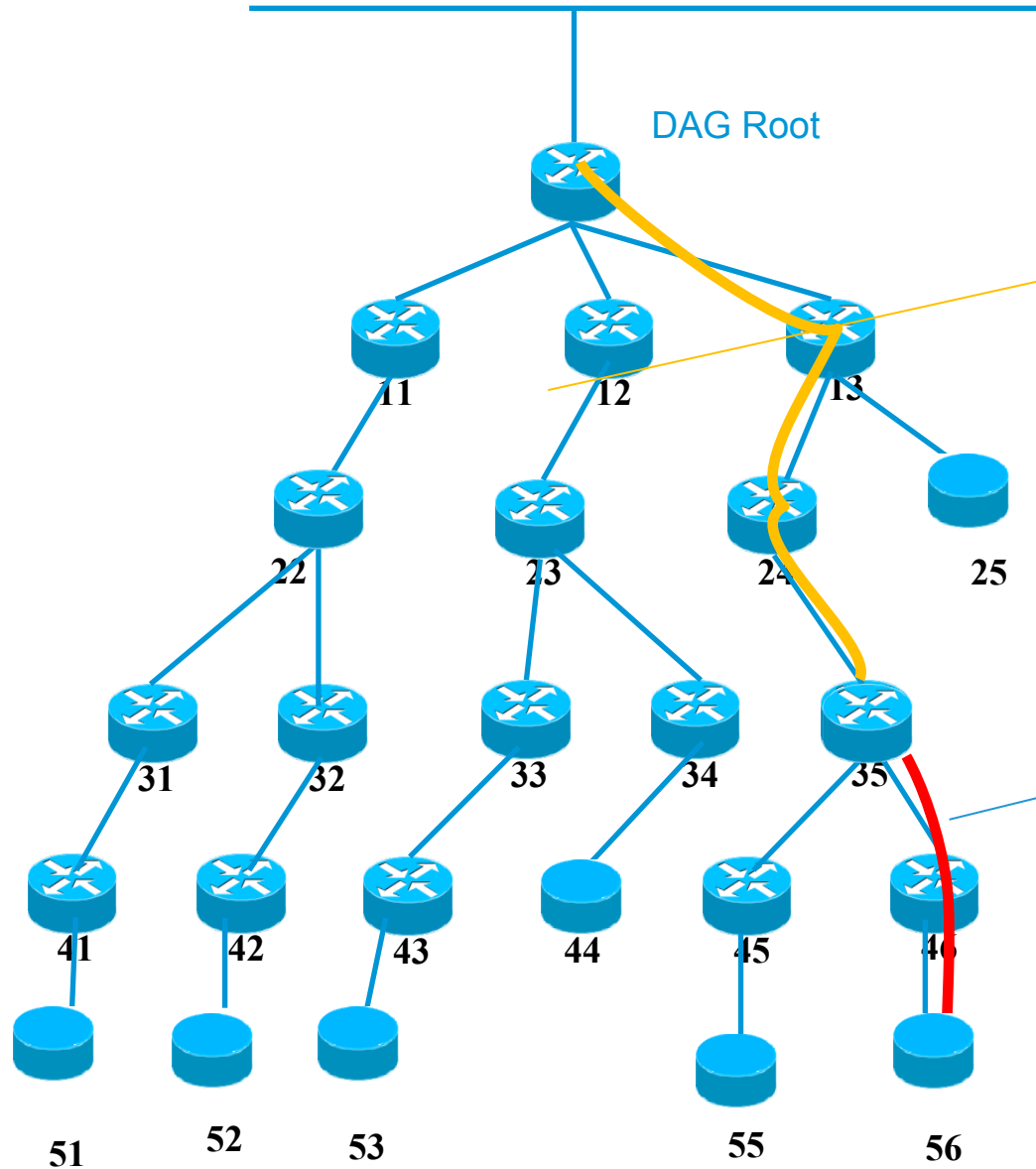

Loose Source routed DATA Path Packet to 12, RH 24, 35, 56

Non source routed DATA Path



Application Server D

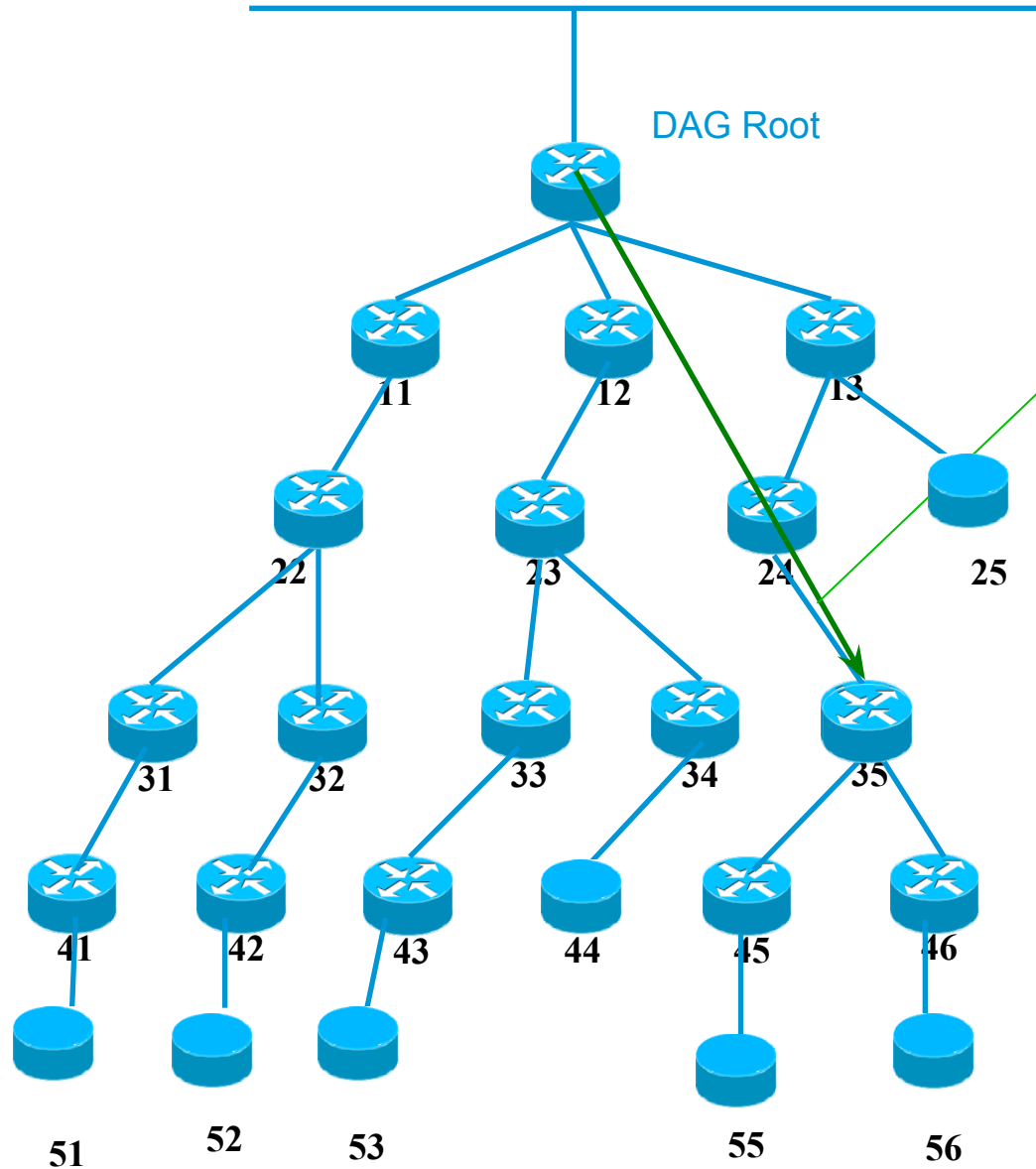

Adding New (projected) DAO with path segment unicast to target 56 via 13 (ingress), 24, and 35 (egress)



Application Server D

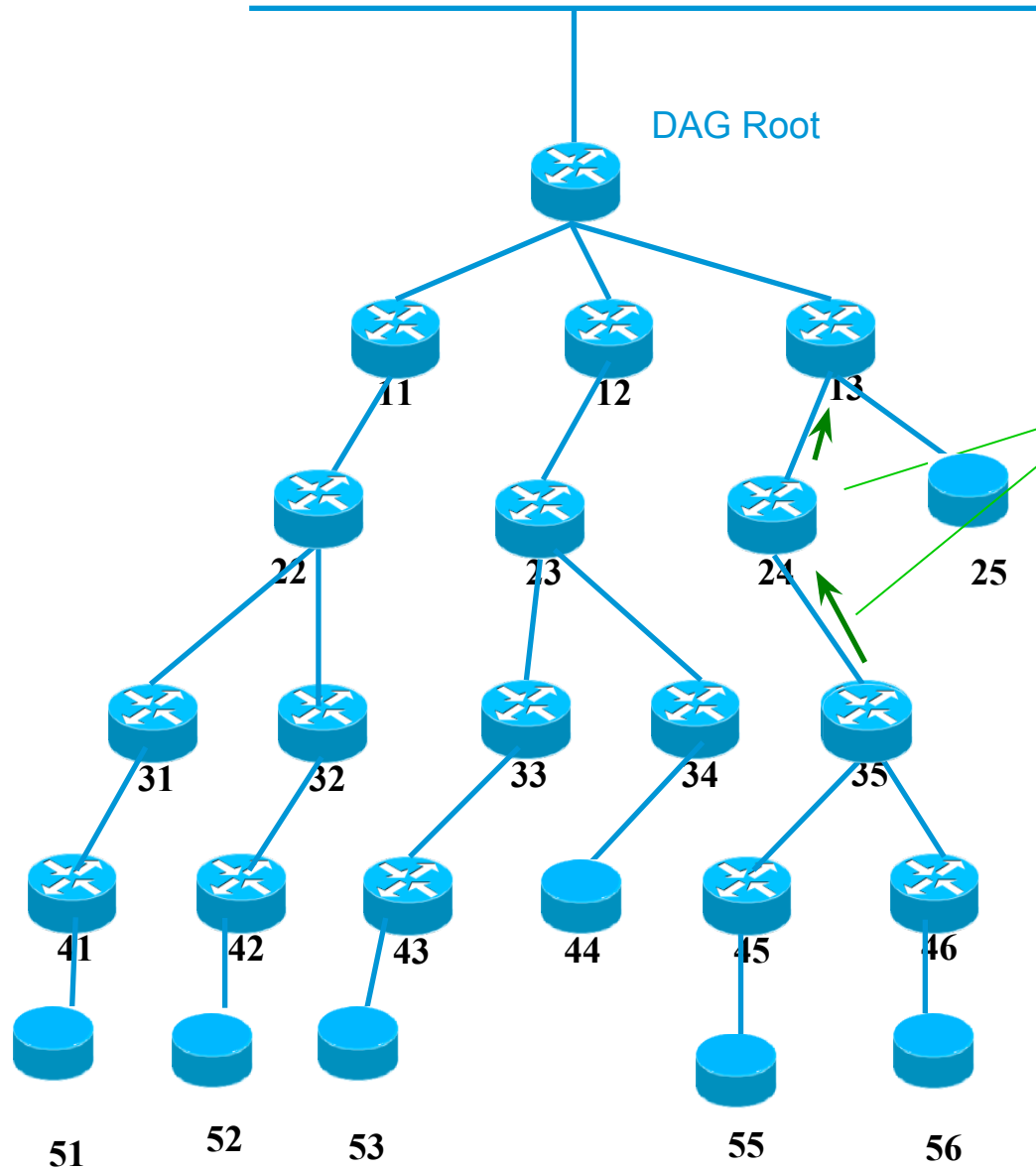

Storing mode DAO (forced) with lifetime along segment



Application Server D

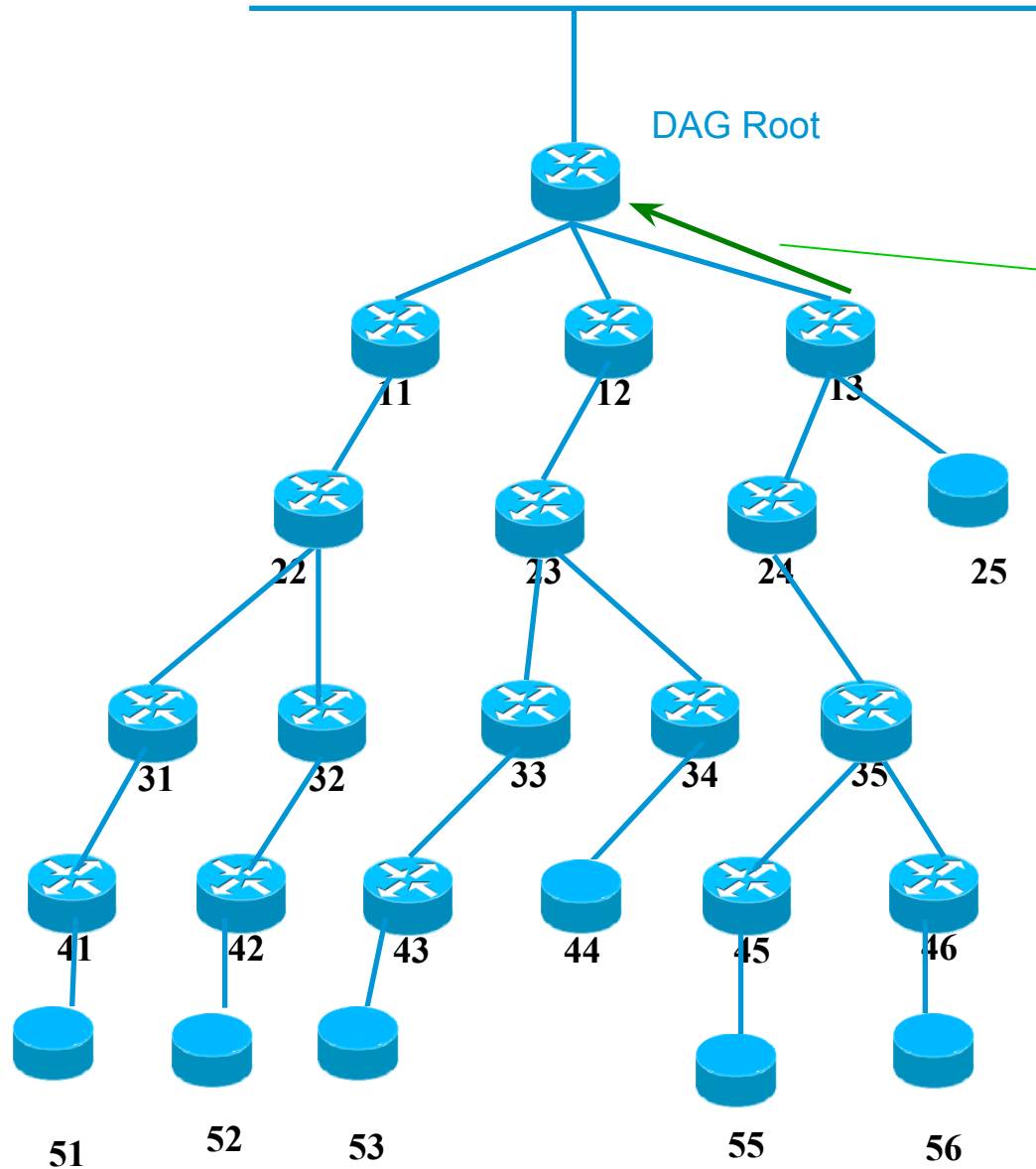

DAO-ACK (alt:
non storing
DAO) unicast,
self 13 as
parent, final
destination 56
as target



Application Server D

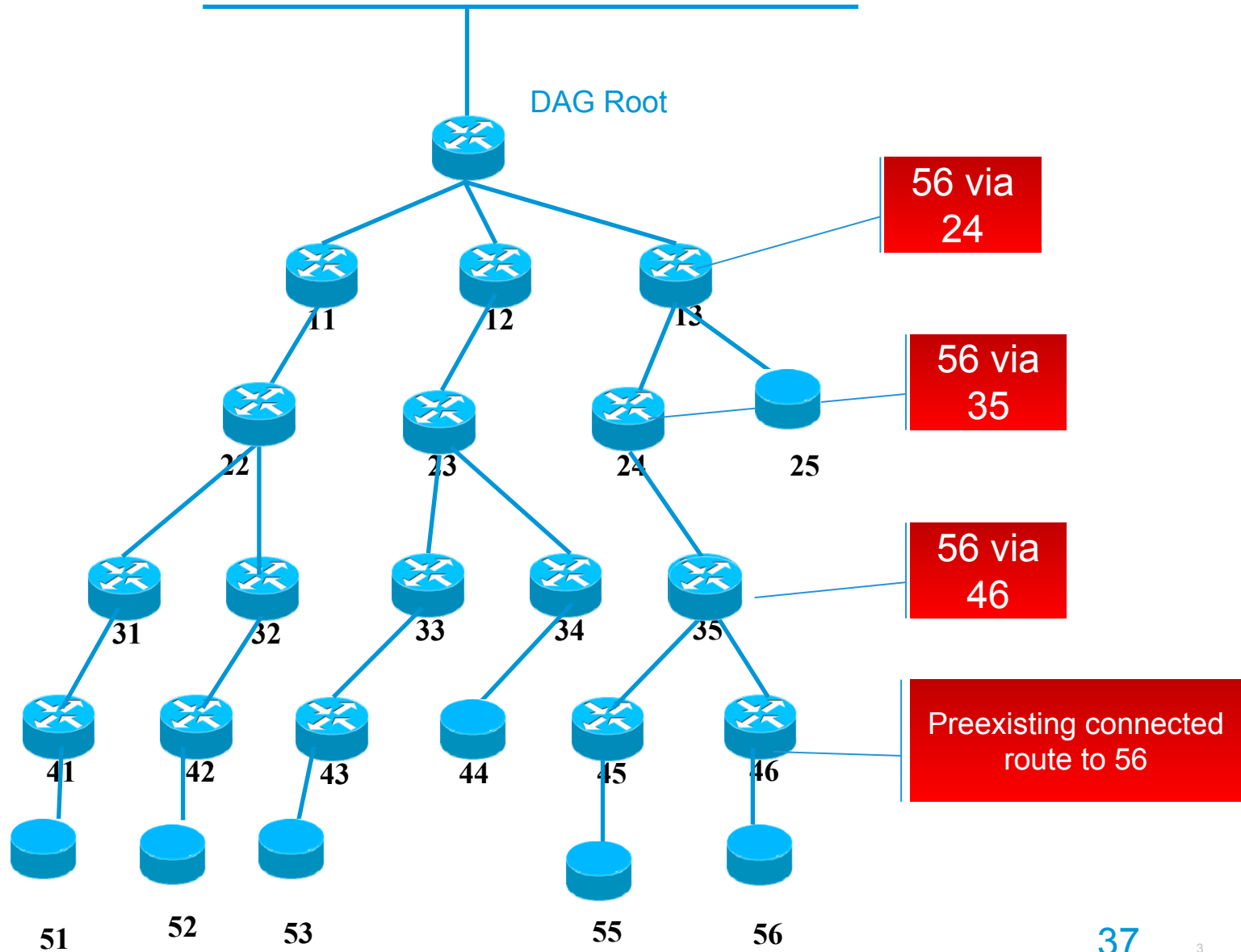



Application Server D

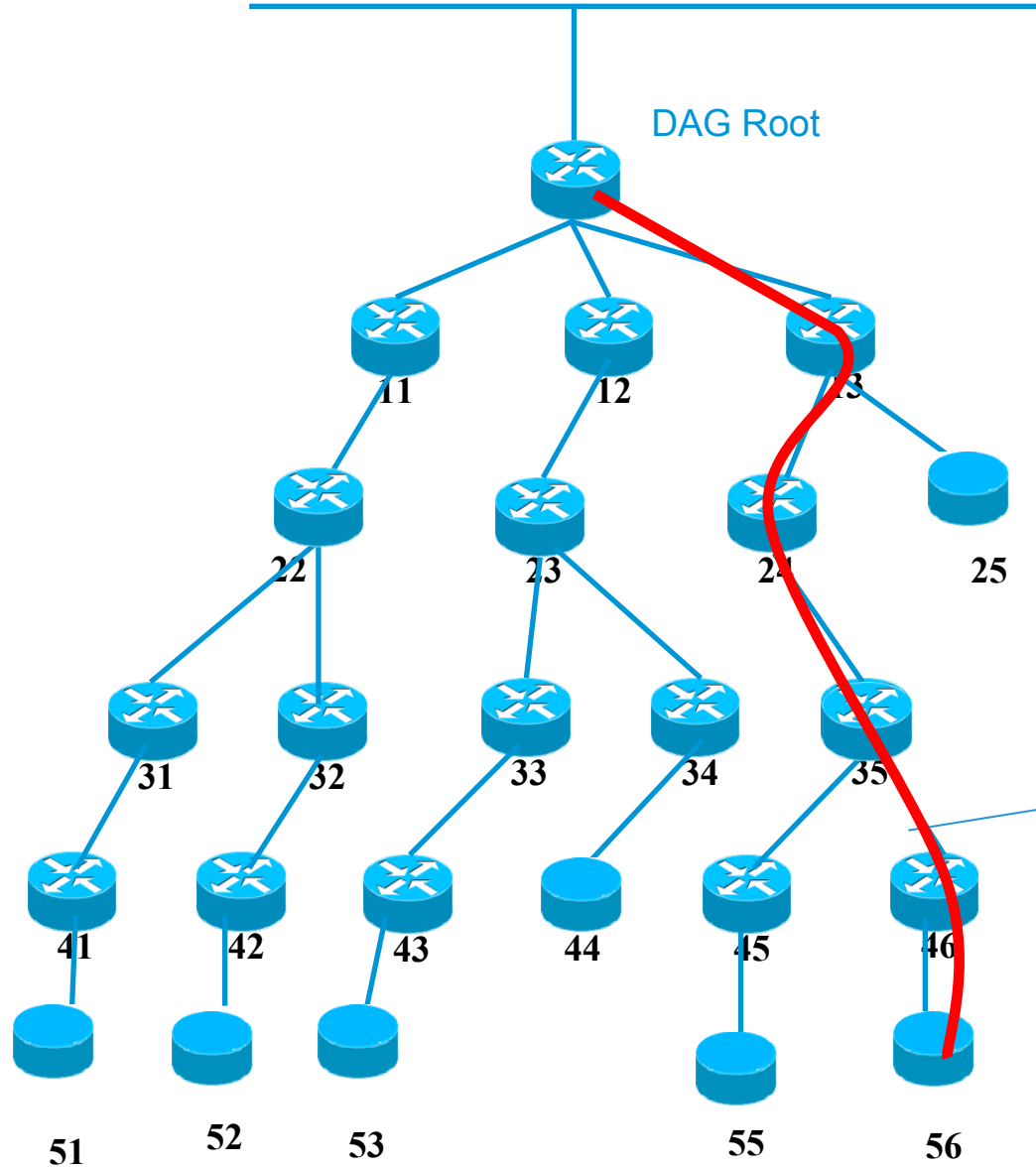

Non source routed DATA Path



Application
Server D

Alternate Programming By the root (Michael)

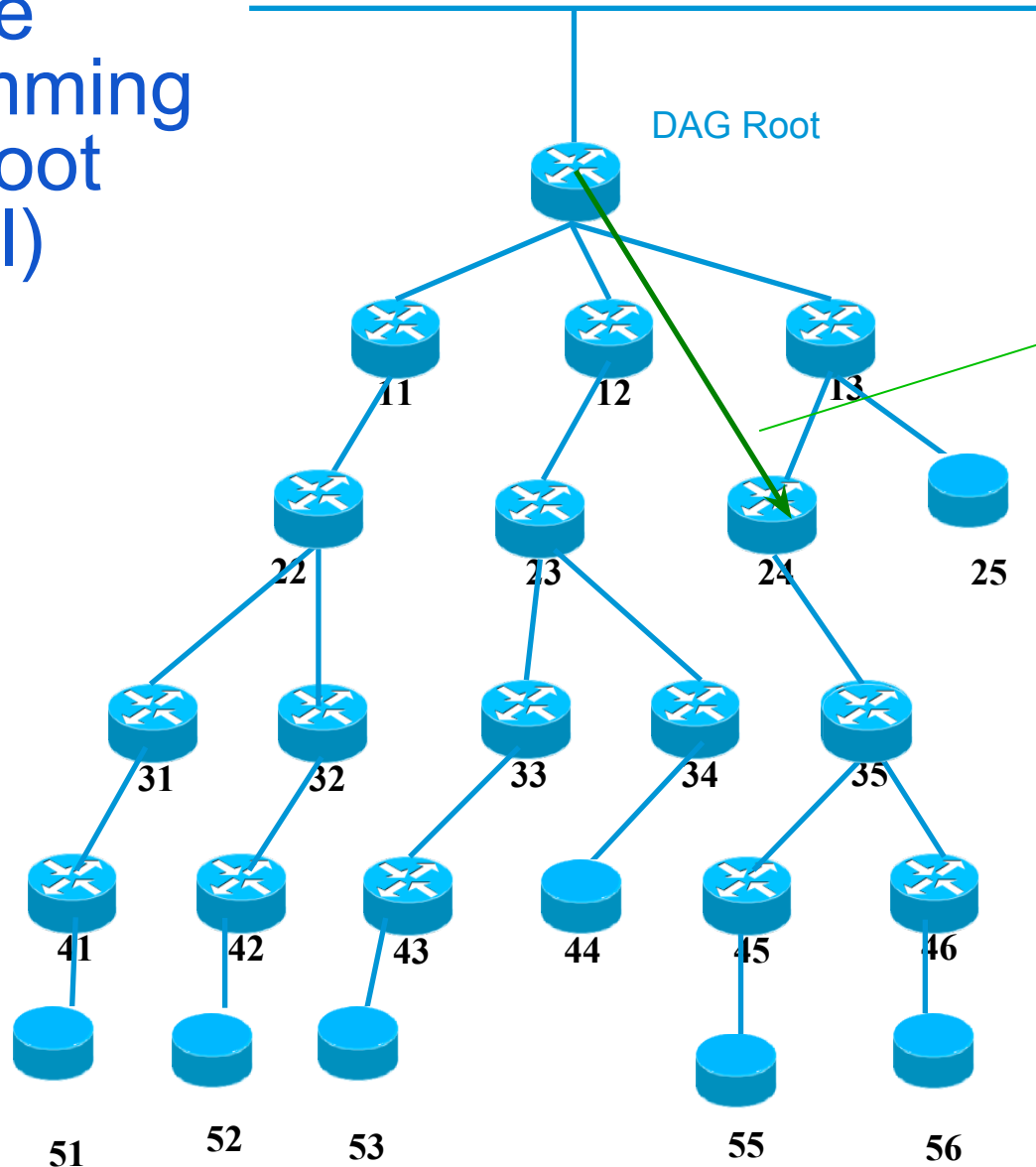

ALT: Adding
New (projected)
DAO with path
segment unicast
to target 35 via
13 (ingress) and
24 (egress)



Application Server D

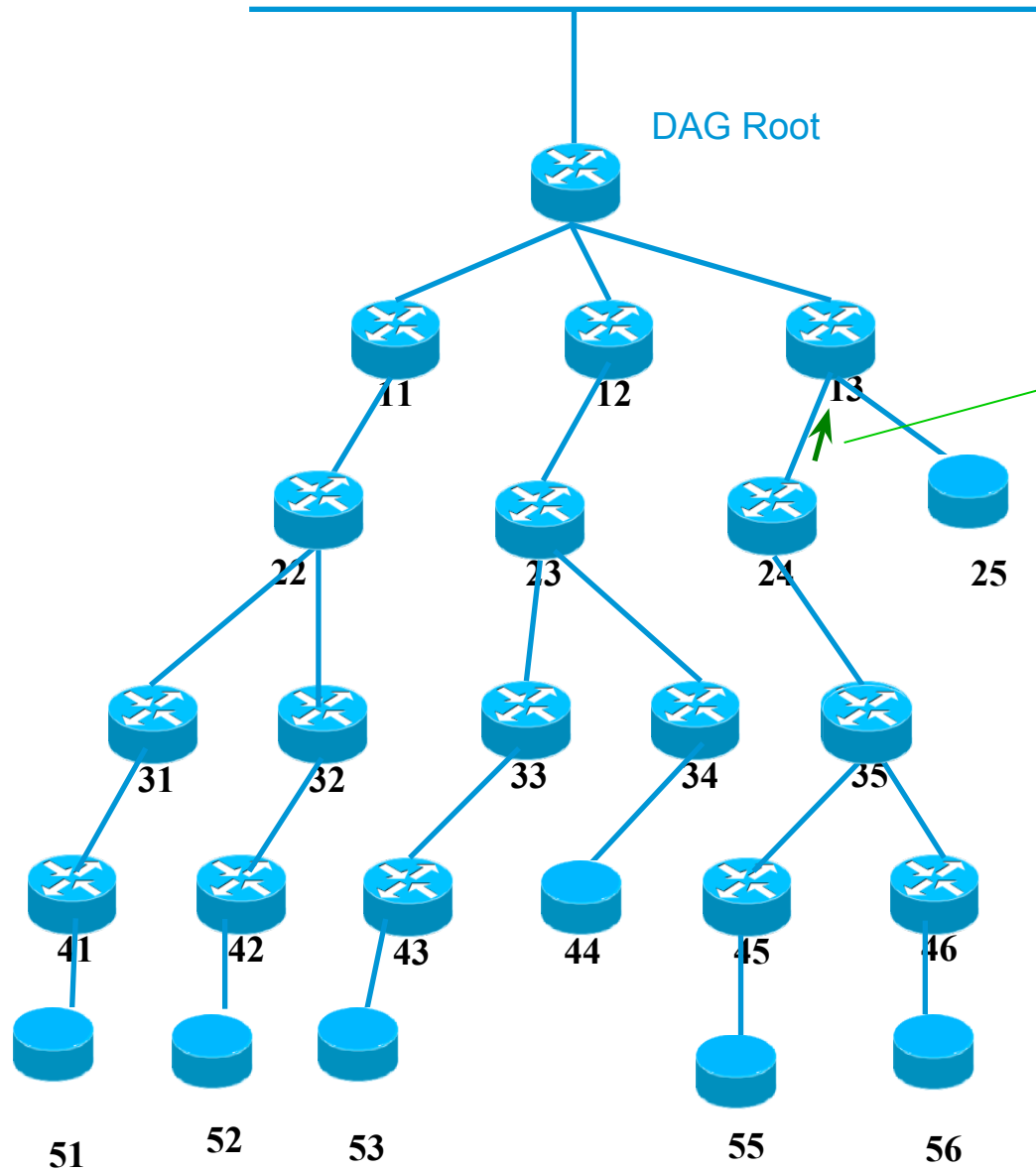

Storing mode DAO (forced) with lifetime along segment



Application Server D

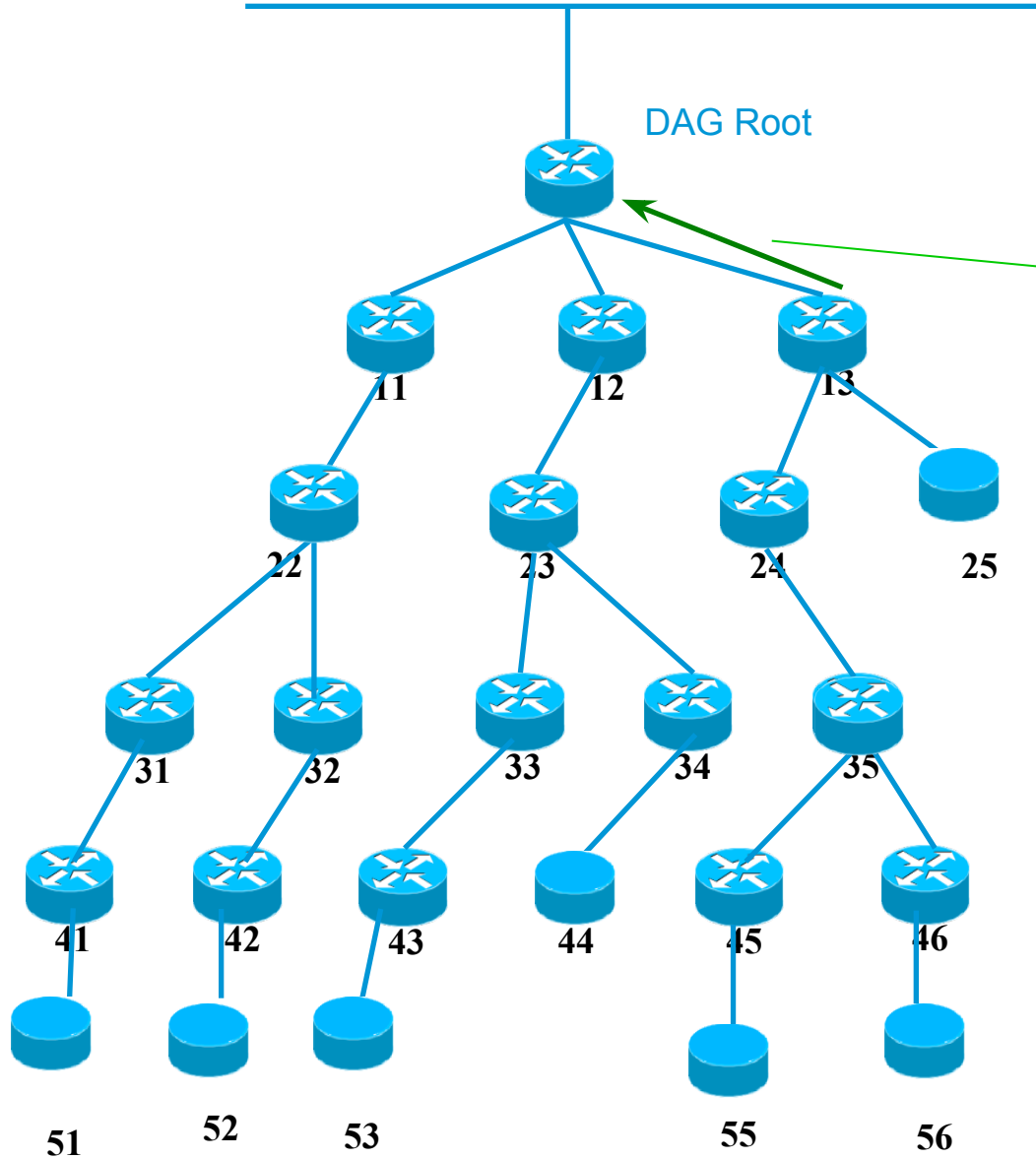

DAO-ACK (alt: non storing DAO) unicast, self 13 as parent, final destination 56 as target



Application Server D

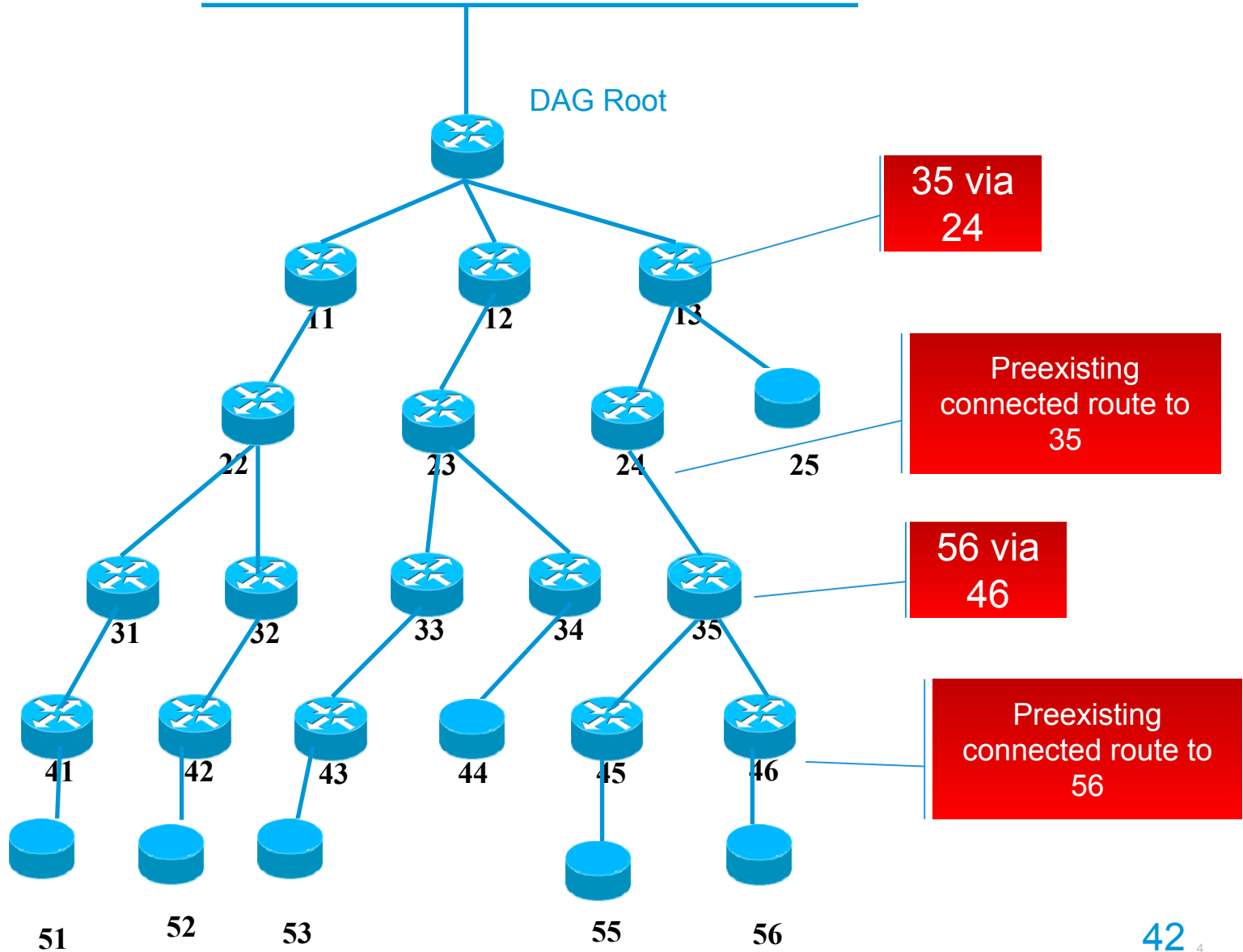



Application Server D

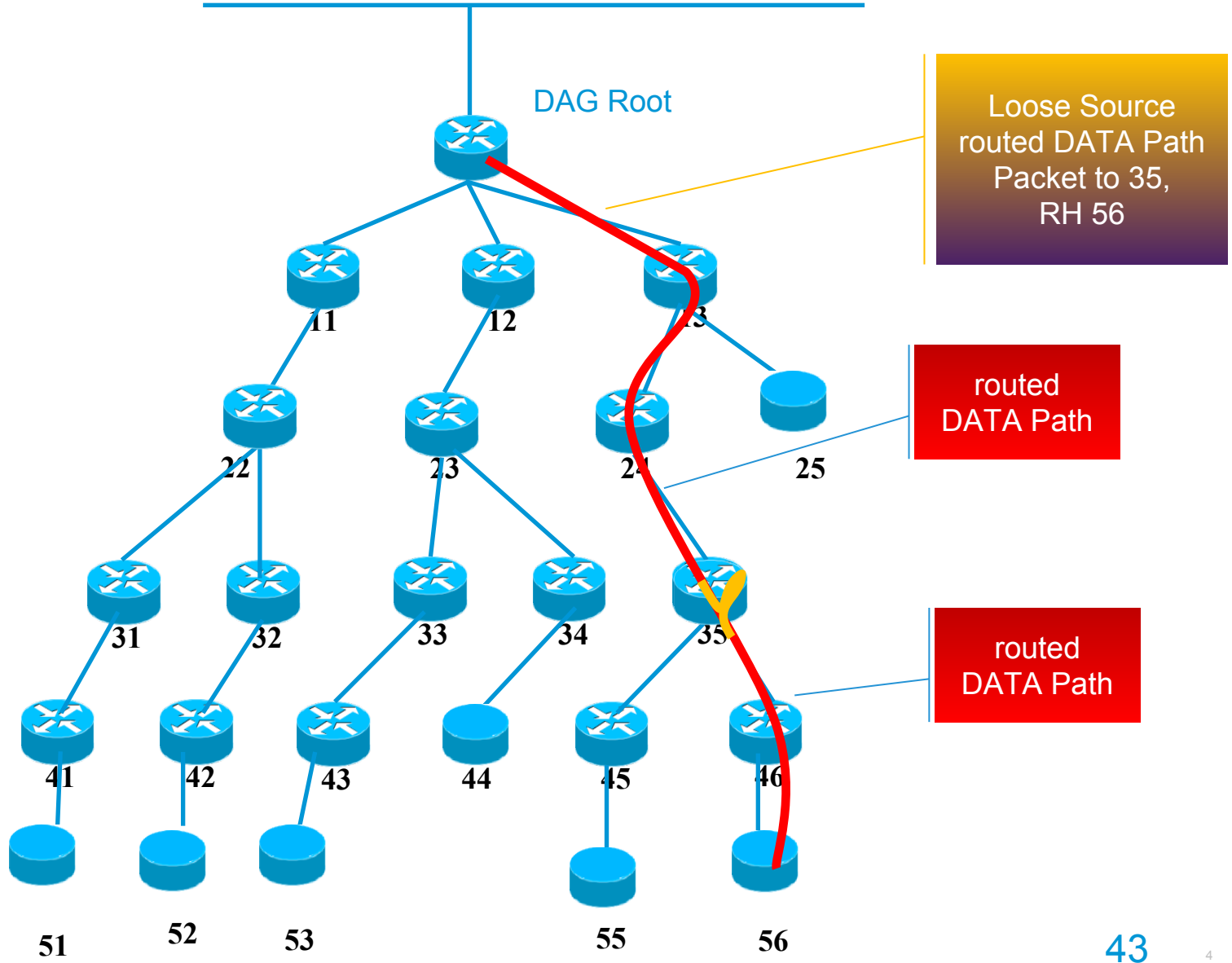

Questions on the list

- Terminology:
 - Segment vs. projected route
 - New msg for “projected DAO”
- Need for a new MOP?
 - Suggestion to add a capability option in node’s original DAOs
- DAO direction, clarify flows
- Transversal routes
- DAO-ACK request bit setting
- -> or non storing DAO?

Open Floor

THANKS!

