

GRE Tunnel Bonding

N. Leymann, C. Heidemann, M. Zhang, Behcet Sarikaya, M. Cullen
zhangmingui@huawei.com

Overview

- GRE tunnels are set up per sub-connection.
- All sub-connections are bonded together to form a single bonding connection.
- The Home Gateway conceals the composing GRE tunnels so that the subscriber uses this bonding connection as if it is a traditional IP link.

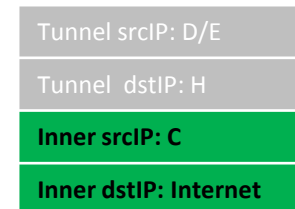
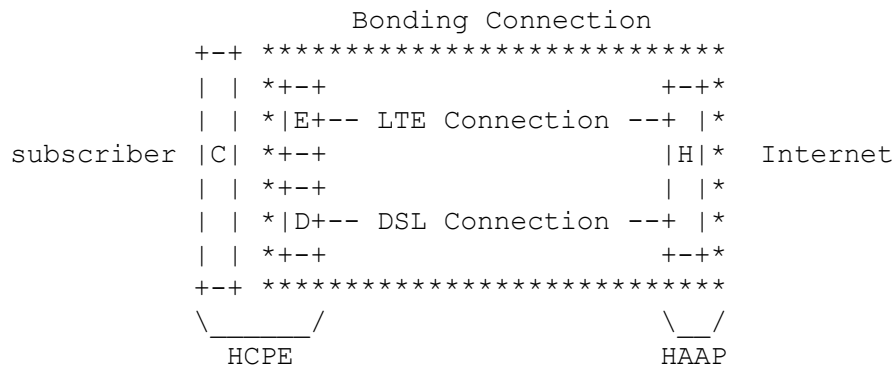

Subscriber's packets are tunneled

Traffic classification, distribution and recombination

- An “offloading” bonding mechanism
 - Using coloring mechanism (RFC 2697 and RFC 2698).
 - Yellow packets are routed through the LTE GRE tunnel and green packets are routed through the DSL GRE tunnel.
 - As such, packet-based traffic distribution is supported.
 - At the egress, packets are reordered according to their sequence numbers.

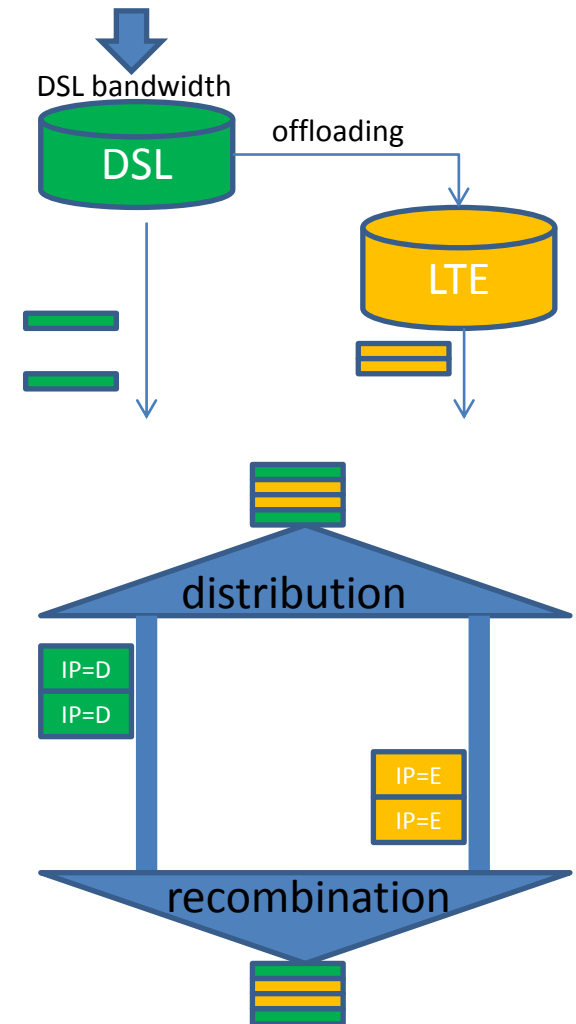

Data Plane

- GRE header defined by RFC 2890 is used.
- For the purpose of packet reordering, each packet through the bonding connection gets a sequence number.
- Both IPv4 (Protocol Type = 0x0800) and IPv6 (Protocol Type = 0x86DD) are supported.
- This provides an L3 overlay: the users' IP packets (inner IP) are encapsulated in GRE which is in turn carried over IP (outer IP).

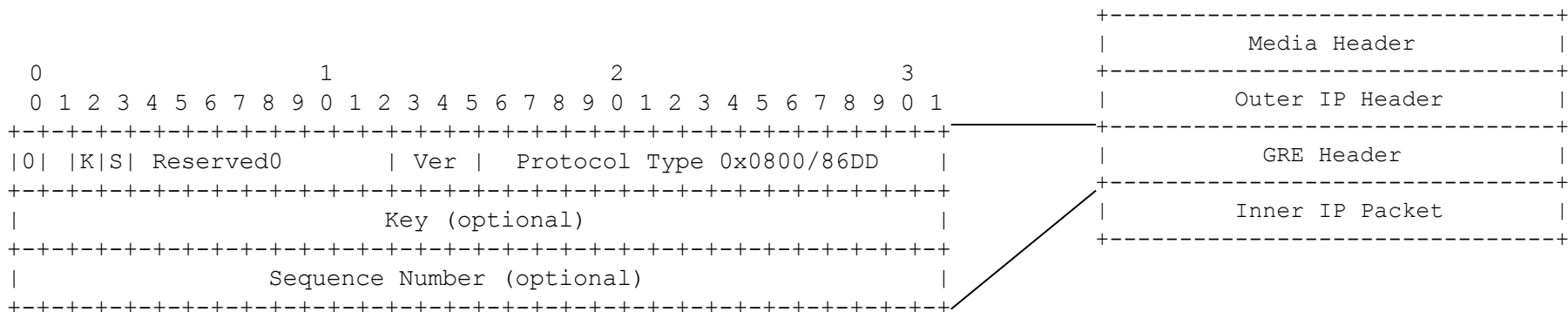

Control plane: the GRE Channel

- A new GRE protocol type (#0xB7EA) for the GRE Channel is assigned by IEEE. This channel is used as the control plane of the GRE-Tunnel-Bonding solution.
- A family of Message Types are defined.
- So, control messages will also be encapsulated as GRE packets! And, they are transmitted in the same tunnels as data packets.

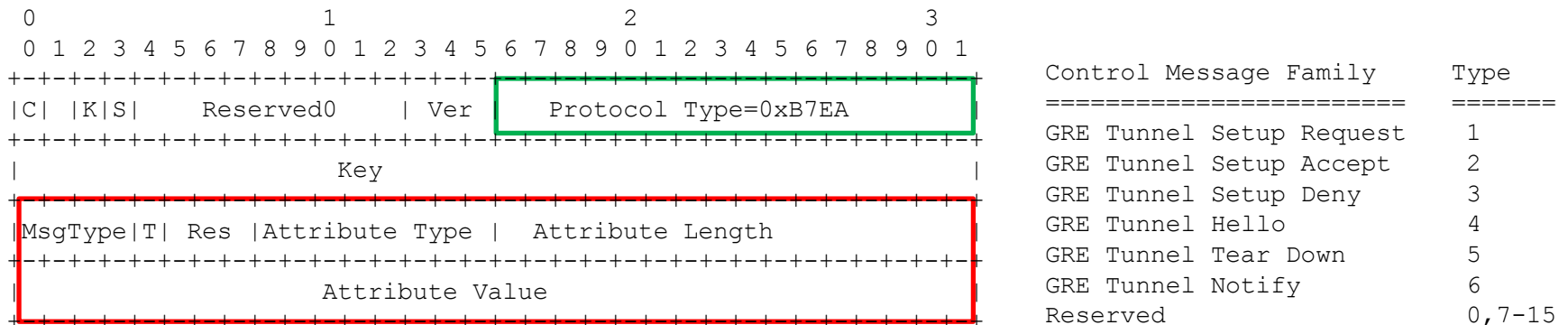

Tunnel establishment, example

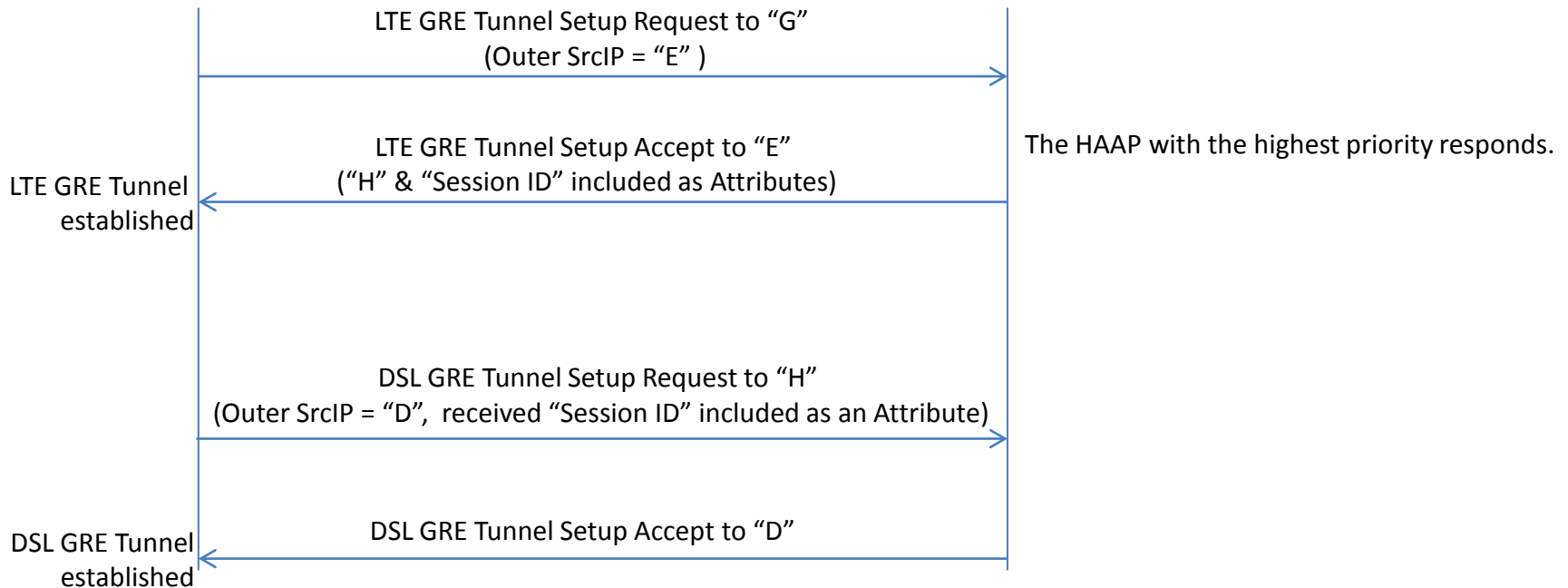
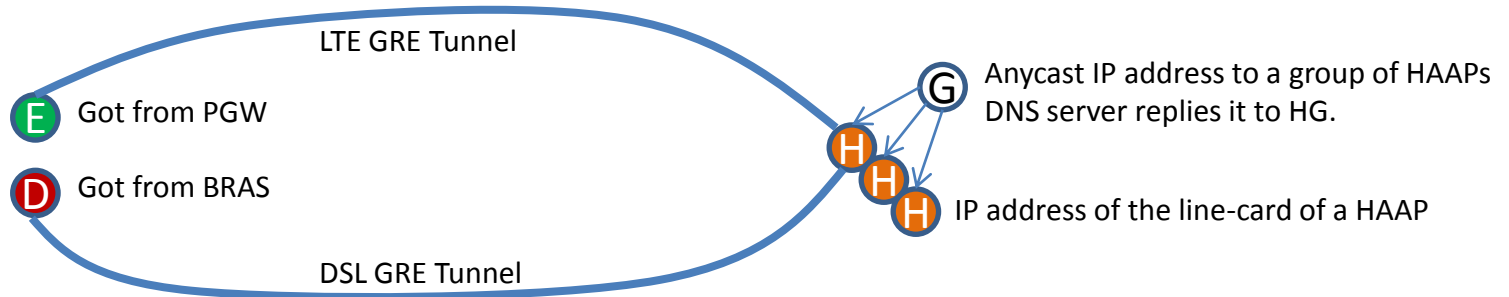

Thanks!